

### Features

- Includes faceplate with handles.
- Top handle controls volume.
- Bottom handle controls temperature setting.
- Supplied with ADA compliant metal lever handles.

### Material

- Complements the Finial® faucet and accessory collections.
- Premium material construction with metal handle ensures reliability and durability.
- KOHLER finishes resist corrosion and tarnishing.

### Installation

- Trim set requires valve to complete installation (sold separately).

### Required Products/Accessories

K-2976-KS 3/4" Thermostatic Mixer

or

K-2973-KS 1/2" Thermostatic Mixing Valve

### Recommended Products/Accessories

K-23723 Faucet cleaner



ADA CSA B651 OBC

### Codes/Standards

ASME A112.18.1/CSA B125.1

ADA

ICC/ANSI A117.1

CSA B651







OBC

### KOHLER® Faucet Lifetime Limited Warranty

See website for detailed warranty information.

### Available Colors/Finishes

*Color tiles intended for reference only.*

Color	Code	Description
	CP	Polished Chrome
	SN	Vibrant® Polished Nickel
	AF	Vibrant® French Gold
	PB	Vibrant® Polished Brass
	BN	Vibrant® Brushed Nickel
	BV	Vibrant® Brushed Bronze
	2BZ	Oil-Rubbed Bronze

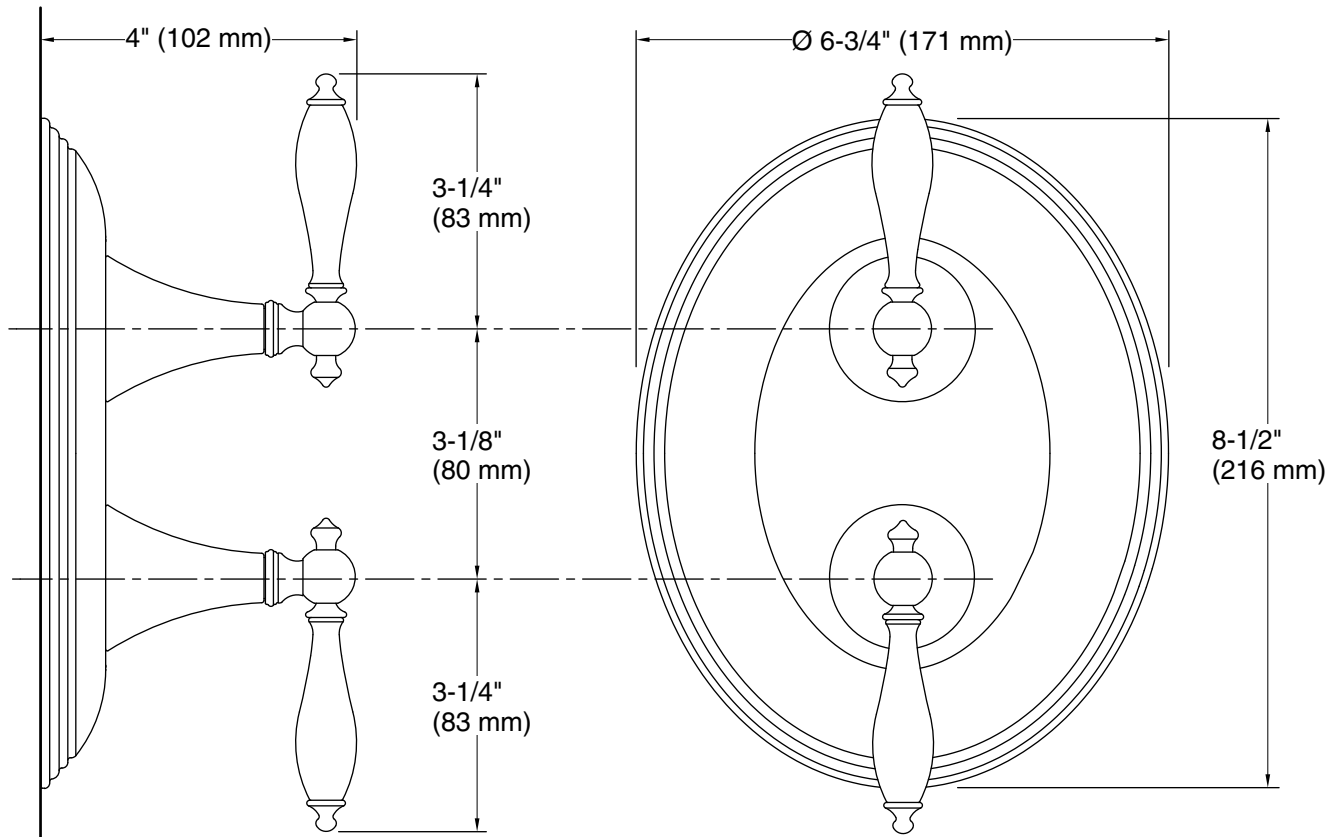

### Technical Information

All product dimensions are nominal.

### Notes

Install this product according to the installation instructions.

ADA, OBC, CSA B651 compliant when installed to the specific requirements of these regulations.