

HYGIENE WASTE BIN WITH SANITARY BAG DISPENSER AND INSERTION SLUICE WITH VANITY FLAP WP177-1



220 x 344 x 115 mm

Capacity approx. 4 l

- Hygiene waste bin with sanitary bag dispenser and insertion sluice with vanity flap in robust, germ-reducing and easy-care stainless steel (AISI 304).
- All-stainless steel housing; visible surfaces satin finished and brushed.
Further available surfaces: see below.
- Equipped with removable hygiene bin. Capacity approx. 4 l.
- Sanitary bag dispenser integrated on the side. Designed for one standard box of plastic sanitary bags with dimensions of approx. 118 x 87 x 20 mm.
- Accessible through hinged lid.
- Mounting: With four screws through key holes and one optional anti-theft hole in the back wall.
- Delivery includes fixing material and one box of plastic sanitary bags.
- Weight, including single package: 3.7 kg



Suggested text for specifications:

Hygiene waste bin with sanitary bag dispenser and insertion sluice with vanity flap in stainless steel (AISI 304) for surface mounting. All-stainless steel housing; visible surfaces satin finished and brushed. Equipped with removable hygiene bin. Capacity approx. 4 l. Sanitary bag dispenser integrated on the side. Accessible through hinged. Delivery includes fixing material and one box of plastic sanitary bags.

Dimensions: 220 x 344 x 115 mm

Article No. WP177-1

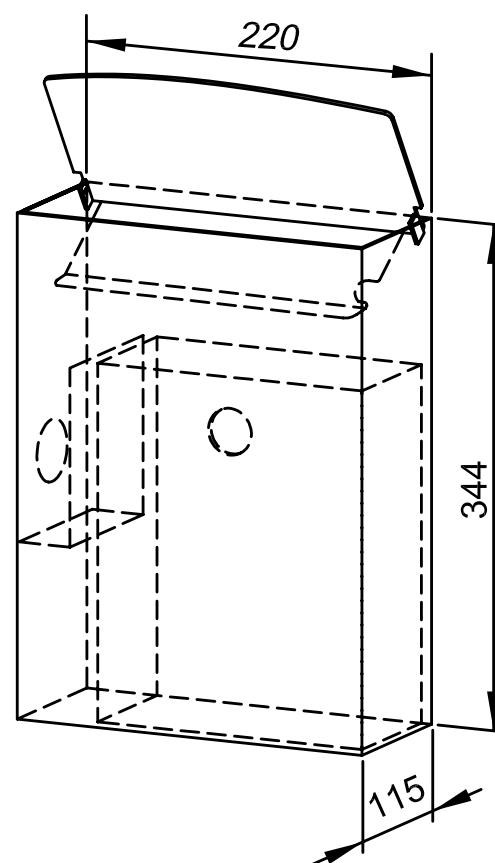

Available surfaces	ID No.
satin finished (standard)	727 240
highly polished	732 240
(coloured) plastic powder-coating	729 240

Ernst Wagner GmbH & Co. KG

Ernst-Abbe-Straße 21 · D-72770 Reutlingen · Tel.: +49712151539-0 · Fax: -20
info@wagner-ewar.de · www.wagner-ewar.de

WAGNER
EWAR