

LIQUID SOAP DISPENSER WP208



148 x 448 x 120 mm

950 ml soap bottle or 850 ml plug-in tank

- Liquid soap dispenser in robust, germ-reducing and easy-care stainless steel (AISI 316L).
- All-stainless steel housing; all corners fully welded, visible surfaces satin finished and brushed. Further available surfaces: see below.
- One-hand operated and non-drip soap pump.
- Designed for standard 950 ml disposable bottles of liquid soap or hand lotion.
- Also refillable with large container using the plug-in tank as an option.
- Inspection slot to indicate fill level.
- Accessible for refilling through lockable, removable front panel with fall protection.
- Keyed alike cylinder lock in corrosion-resistant zinc die-casting.
- Wear parts and front panel can be replaced as modules.
- Installation dimensions: 150 x 450 x 110 mm
- Mounting: With four screws in wall opening through fixing holes in the side walls.
- Delivery includes fixing material and first fill with soap.
- Weight, including single package: 3.9 kg



Suggested text for specifications:

Liquid soap dispenser in stainless steel (AISI 316L) for flush mounting. All-stainless steel housing; all corners fully welded, visible surfaces satin finished and brushed. One-hand operated and non-drip soap pump. Designed for standard 950 ml disposable bottles of liquid soap or hand lotion. Inspection slot to indicate fill level. Accessible for refilling through lockable, removable front panel with fall protection. Keyed alike cylinder lock in corrosion-resistant zinc die-casting. Delivery includes fixing material and first fill with soap.

Dimensions: 148 x 448 x 120 mm

Article No. WP208

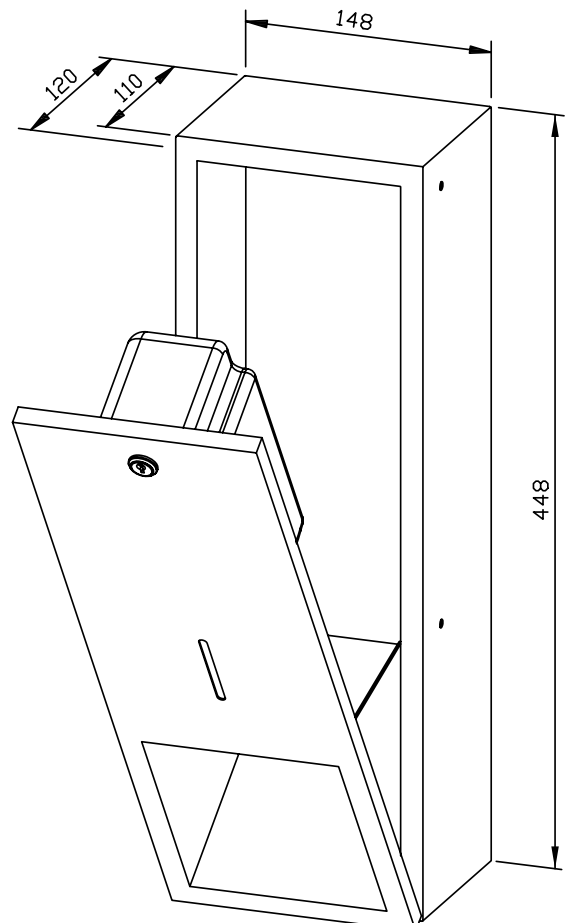

Options	ID No.
Plug-in tank 850 ml	937 201

Available surfaces	ID No.
satin finished (standard)	727 596
highly polished	731 596
(coloured) plastic powder-coating	728 146

Ernst Wagner GmbH & Co. KG

Ernst-Abbe-Straße 21 · D-72770 Reutlingen · Tel.: +49712151539-0 · Fax: -20
info@wagner-ewar.de · www.wagner-ewar.de

WAGNER
EWAR