

Features

- Bask® heated surface creates spa-like relaxation with soothing warmth on your back, shoulders, and neck.
- Three heat settings allow you to customize the surface temperature.
- Hourglass shape adds style and elegance to your bathroom.
- Generous 6-foot length provides an incredibly spacious bathing area.
- Textured bottom surface.

Material

- Acrylic.

Installation

- Reversible drain.
- Drop-in.

Recommended Products/Accessories

- K-1283 Removable Apron
- K-1491 Bath/Whirlpool Pillow
- K-24916 Wireless Music Kit
- K-23726 Drain treatment
- K-23732 Tub & shower cleaner
- K-37380 30" Rough-in Cable Bath Drain
- K-37383 Rough-in cable bath drain, PVC, 30" cable with tubing
- K-7265 Brass toe tap bath drain
- K-37386 rough-in cable drain, PVC, 30" cable
- K-7213 27" Cable Bath Drain



Codes/Standards

CSA B45.5/IAPMO Z124
ASTM E162
ASTM E662
UL 1795





**KOHLER® Plastic Baths and Receptors
Lifetime Limited Warranty
KOHLER® Hydrotherapy Components
Five-Year Limited Warranty**

See website for detailed warranty information.

Available Colors/Finishes

Color tiles intended for reference only.

Color	Code	Description
-------	------	-------------

	0	White
	96	Biscuit
	47	Almond
	NY	Dune
	G9	Sandbar

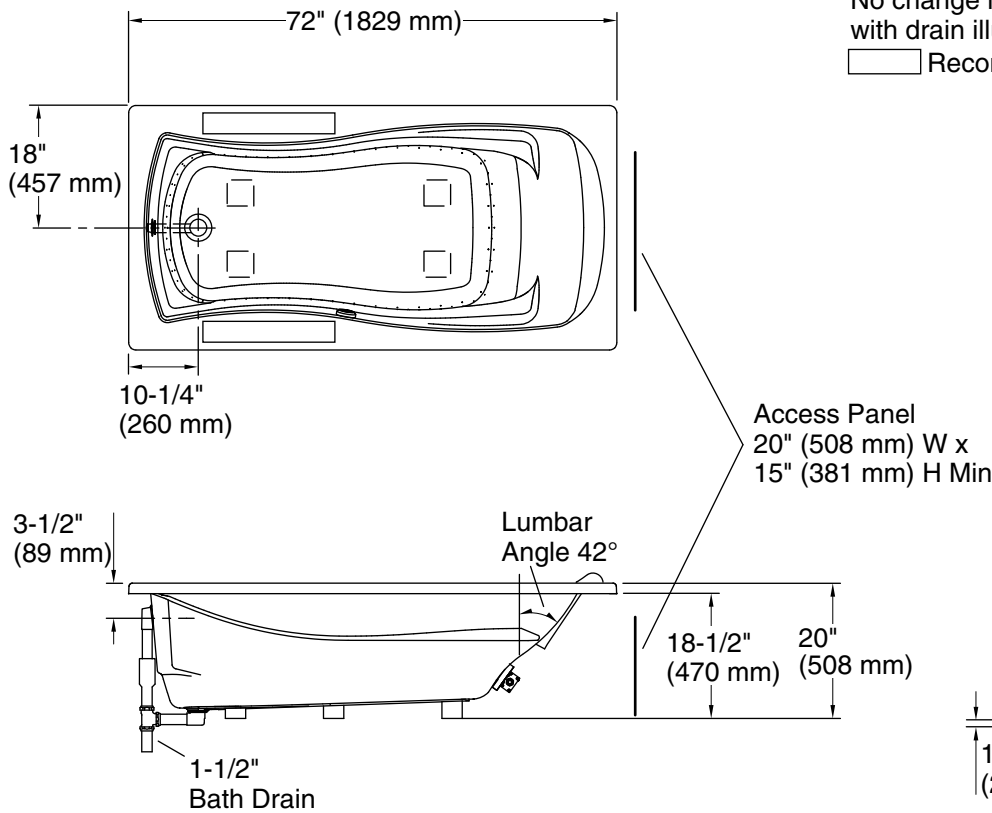

No change in measurements if connected with drain illustrated. (K-7166-AF)

□ Recommended Faucet Location

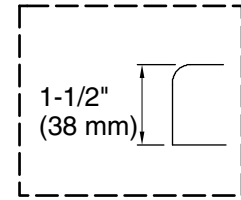

Drop-in Rim Detail

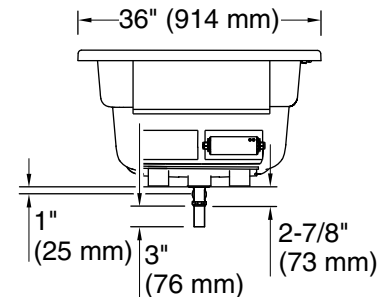

Required Electrical Service

One circuit required, protected with Class A Ground-Fault Circuit-Interrupter (GFCI). Outside North America, this device may be known as a Residual Current Device (RCD).

Heated Surface: 120 V, 15 A

Technical Information

All product dimensions are nominal.

Installation:	Drop-in
Drain location:	End
Basin area, bottom:	50" x 24" (1270 mm x 610 mm)
Basin area, top:	65" x 27" (1651 mm x 686 mm)
Weight:	77 lbs (34.9 kg)
Minimum floor load:	39.1 lbs/ft ² (190.9 kg/m ²)
Water depth:	14" (356 mm)
Water capacity:	72 gal (272.5 L)
Electrical component rating:	Heated Surface: 120 V, 0.5 A, 60 Hz, 65 W
Minimum flat for door:	2-1/8" (54 mm)

Notes

Measure your actual product for rough-in details. Install this product according to the installation instructions.

The hot water supply should be 70% of the capacity of the bath or greater. Installations will vary.

If installing a rim-mount faucet, make sure there is no interference above or below the deck before drilling any holes.