

TABLETOP SOAP DISPENSER, LOCKABLE WP189-3



65 x 359 x 120 mm

stainless steel

- Tabletop soap dispenser, lockable, in robust, germ-reducing and easy-care stainless steel (AISI 316L).
- Solid stainless steel body; visible surfaces satin finished. Further available surfaces: see below
- Design height: 111 mm
Outlet height: 62 mm
Projection: 66 mm
- Non-drip soap pump with 500 ml soap container in plastics and pressure valve in stainless steel.
- Also available with 250 ml or 1000 ml containers in plastics.
- 500 ml container in stainless steel as an option for a surcharge.
- Designed for standard liquid soaps.
- Refillable from above by unscrewing the top part, secured with hexagon socket screw.
- Wear parts can be replaced as modules.
- Installation dimensions: Ø 22-26 mm, surface thickness max. 40 mm.
- Mounting: With one counternut.
- Delivery includes fixing material.
- Weight, including single package: 1.3 kg



Suggested text for specifications:

Tabletop soap dispenser, lockable, in stainless steel (AISI 316L) for counter mounting. Solid stainless steel body; visible surfaces satin finished. Non-drip soap pump with 500 ml soap container in plastics and pressure valve in stainless steel. Designed for standard liquid soaps. Refillable from above by unscrewing the top part, secured with hexagon socket screw. Delivery includes fixing material.

Dimensions: (with container) 65 x 359 x 130 mm

Design height: 111 mm

Outlet height: 62 mm

Projection: 66 mm

Article No. WP189-3

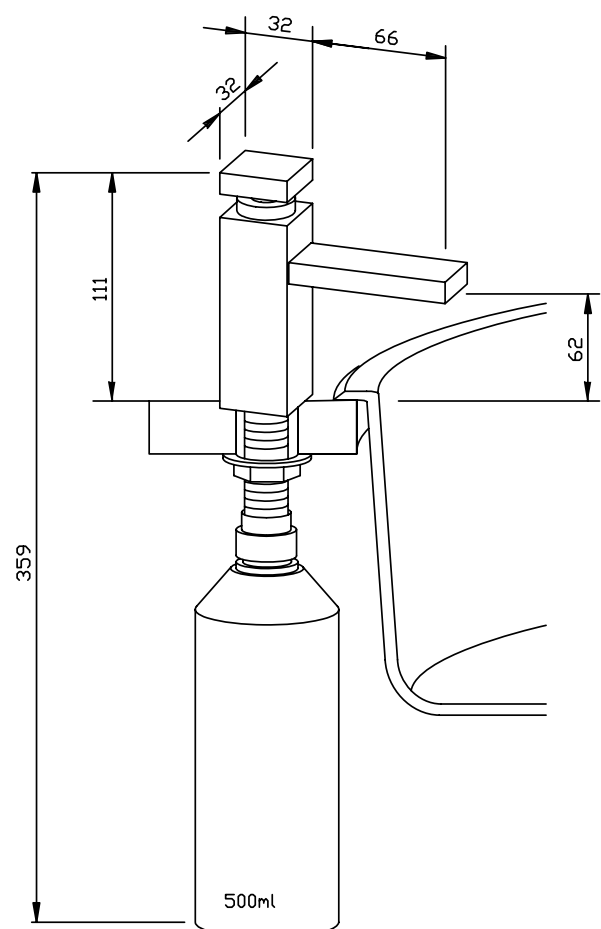

Available surfaces	ID No.
satin finished (standard)	923 376
highly polished	931 376

Ernst Wagner GmbH & Co. KG

Ernst-Abbe-Straße 21 · D-72770 Reutlingen · Tel.: +49712151539-0 · Fax: -20
info@wagner-ewar.de · www.wagner-ewar.de

WAGNER
EWAR