

PAPER TOWEL DISPENSER WP113



298 x 298 x 120 mm

approx. 500 paper towels

- Paper towel dispenser in robust, germ-reducing and easy-care stainless steel (AISI 304).
- All-stainless steel housing; all corners fully welded, visible surfaces satin finished and brushed. Further available surfaces: see below.
- With deep-drawn paper removal opening for easy paper removal.
- Designed for approx. 500 standard paper towels in zigzag fold. Paper size (folded): 240-250 mm x 100-115 mm.
- Inspection slot to indicate fill level.
- Accessible for refilling through lockable front flap with fall protection.
- Keyed alike cylinder lock in corrosion-resistant zinc die-casting.
- Wear parts can be replaced as modules.
- Mounting: With four screws through key holes and one optional anti-theft hole in the back wall.
- Delivery includes fixing material and one pack of paper towels.
- Weight, including single package: 3.1 kg



Suggested text for specifications:

Paper towel dispenser in stainless steel (AISI 304) for surface mounting. All-stainless steel housing; all corners fully welded, visible surfaces satin finished and brushed. With deep-drawn paper removal opening, filling quantity approx. 500 paper towels. Inspection slot to indicate fill level. Accessible for refilling through lockable front flap with fall protection. Keyed alike cylinder lock in corrosion-resistant zinc die-casting. Delivery includes fixing material and one pack of paper towels.

Dimensions: 298 x 298 x 120 mm

Article No. WP113

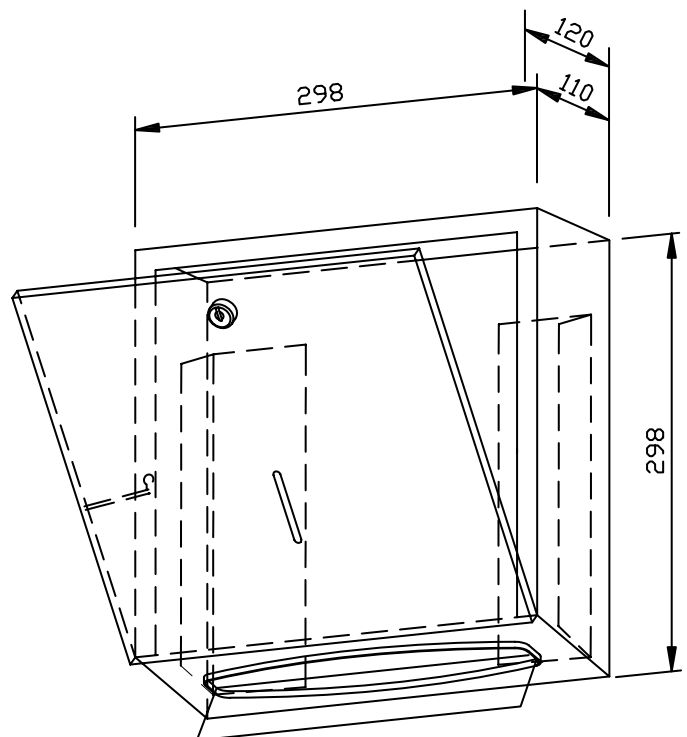

Available surfaces

ID No.

satin finished (standard)

727 433

highly polished

731 433

(coloured) plastic powder-coating

728 125

Ernst Wagner GmbH & Co. KG

Ernst-Abbe-Straße 21 · D-72770 Reutlingen · Tel.: +49712151539-0 · Fax: -20
info@wagner-ewar.de · www.wagner-ewar.de

WAGNER
EWAR