

WASTE BIN WP126



298 x 448 x 170 mm
Capacity approx. 23 l

- Waste bin in robust, germ-reducing and easy-care stainless steel (AISI 304).
- All-stainless steel housing; visible surfaces satin finished and brushed.
Further available surfaces: see below.
- Equipped with removable fabric stand bag in polypropylene, washable. Capacity approx. 23 l.
- Fabric stand bag replaces garbage bag.
- Mounting: With two screws through key holes and one optional anti-theft hole in the back wall.
- Delivery includes fixing material.
- Weight, including single package: 3.6 kg



Suggested text for specifications:

Waste bin in stainless steel (AISI 304) for surface mounting. All-stainless steel housing; visible surfaces satin finished and brushed. Equipped with removable fabric stand bag in polypropylene, washable. Capacity approx. 23 l. Delivery includes fixing material.

Dimensions: 298 x 448 x 170 mm

Article No. WP126

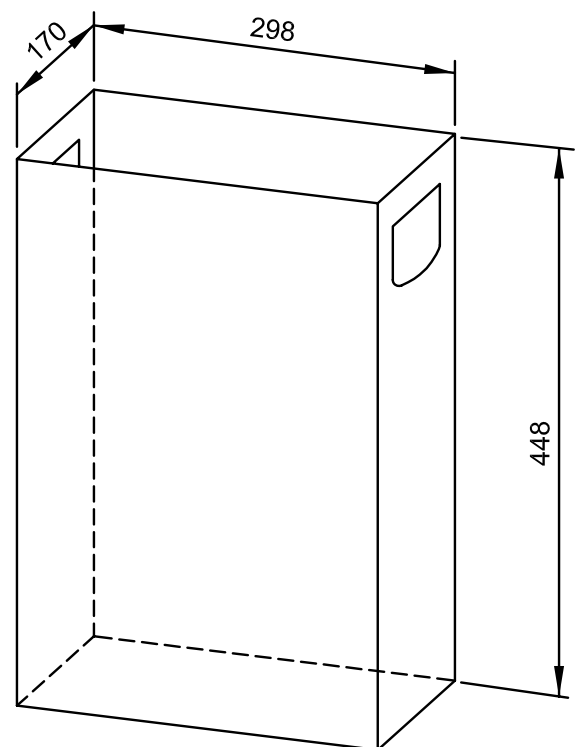

Available surfaces	ID No.
satin finished (standard)	727 733
highly polished	731 733
(coloured) plastic powder-coating	728 080

Ernst Wagner GmbH & Co. KG

Ernst-Abbe-Straße 21 · D-72770 Reutlingen · Tel.: +49712151539-0 · Fax: -20
info@wagner-ewar.de · www.wagner-ewar.de

WAGNER
— EWAR