

 **angel cerdá**

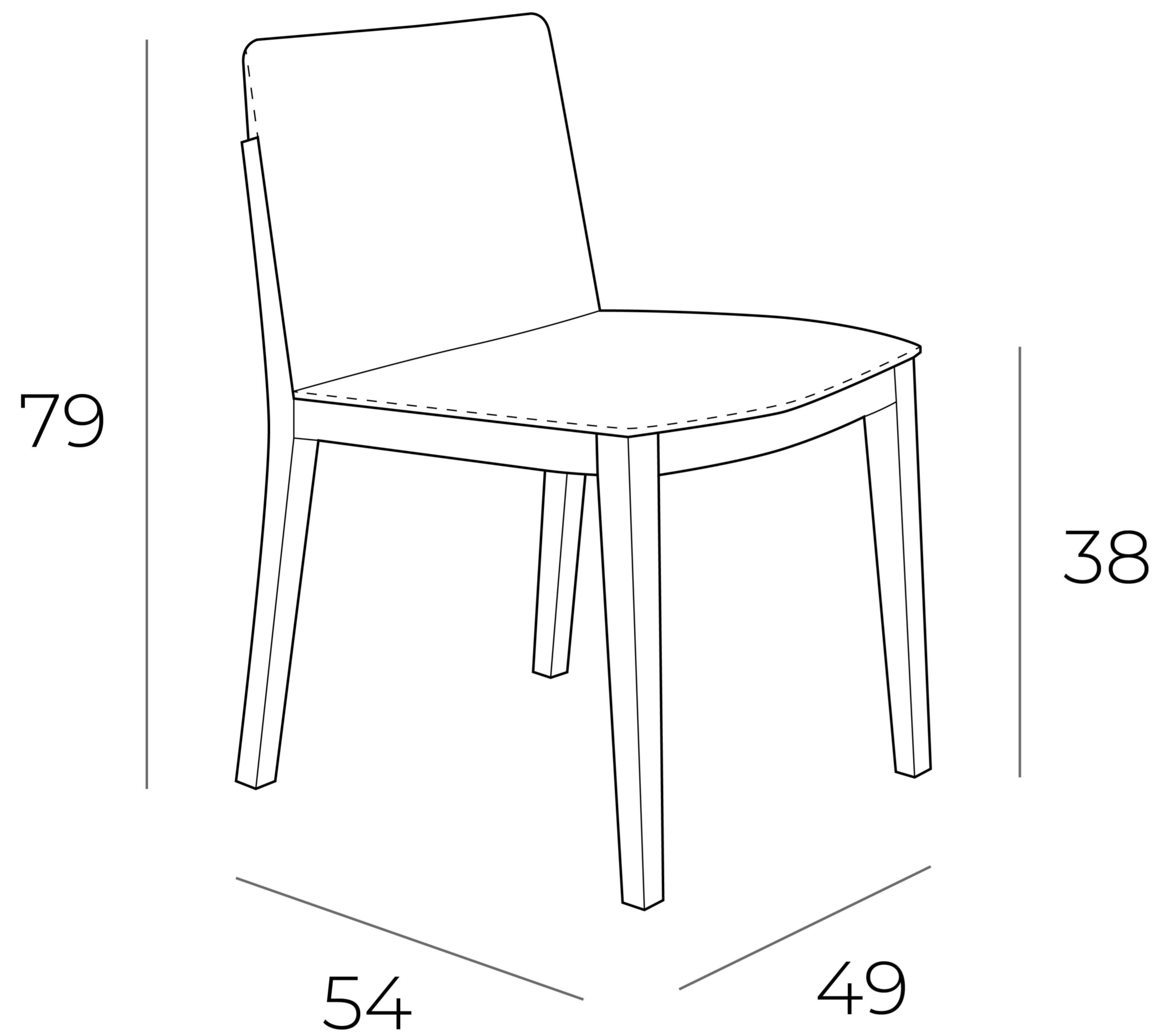

**PACK  
2**



49 x 54 x 79 cm.  
11 kg.

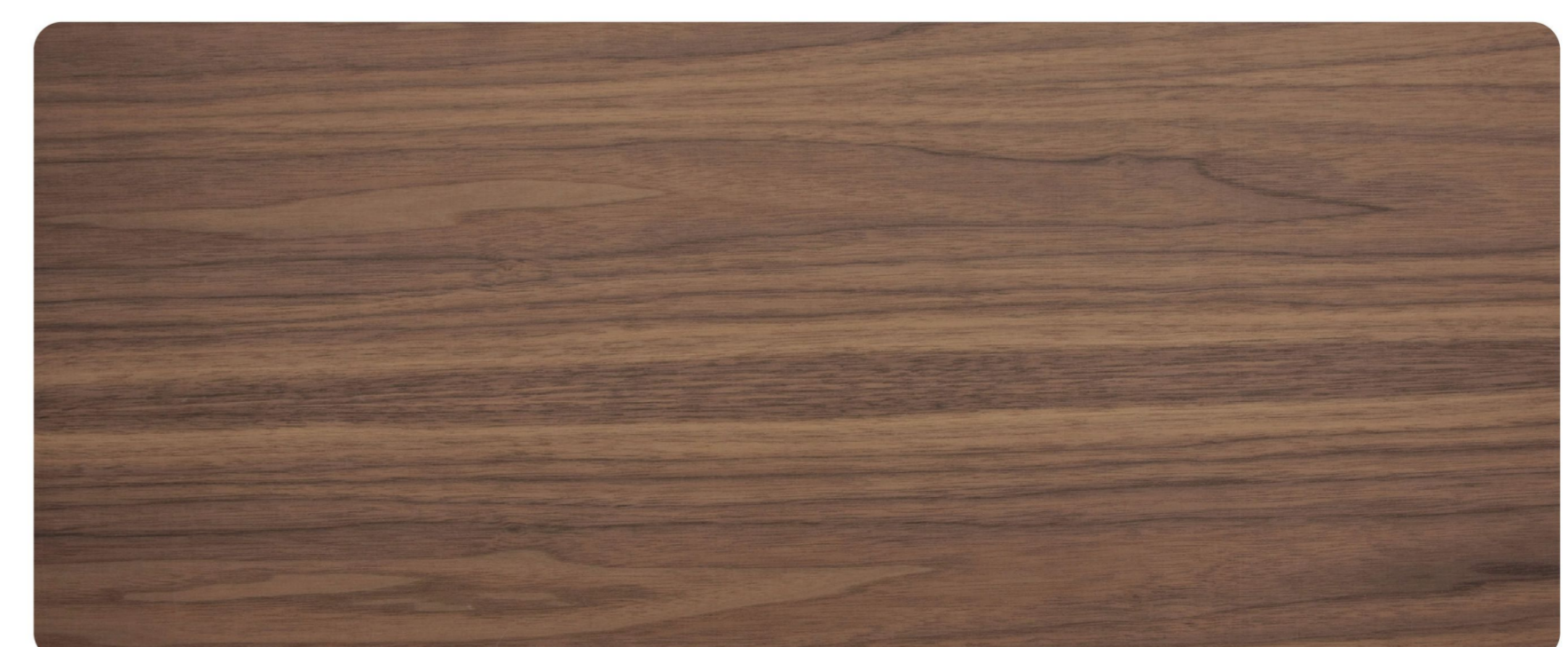
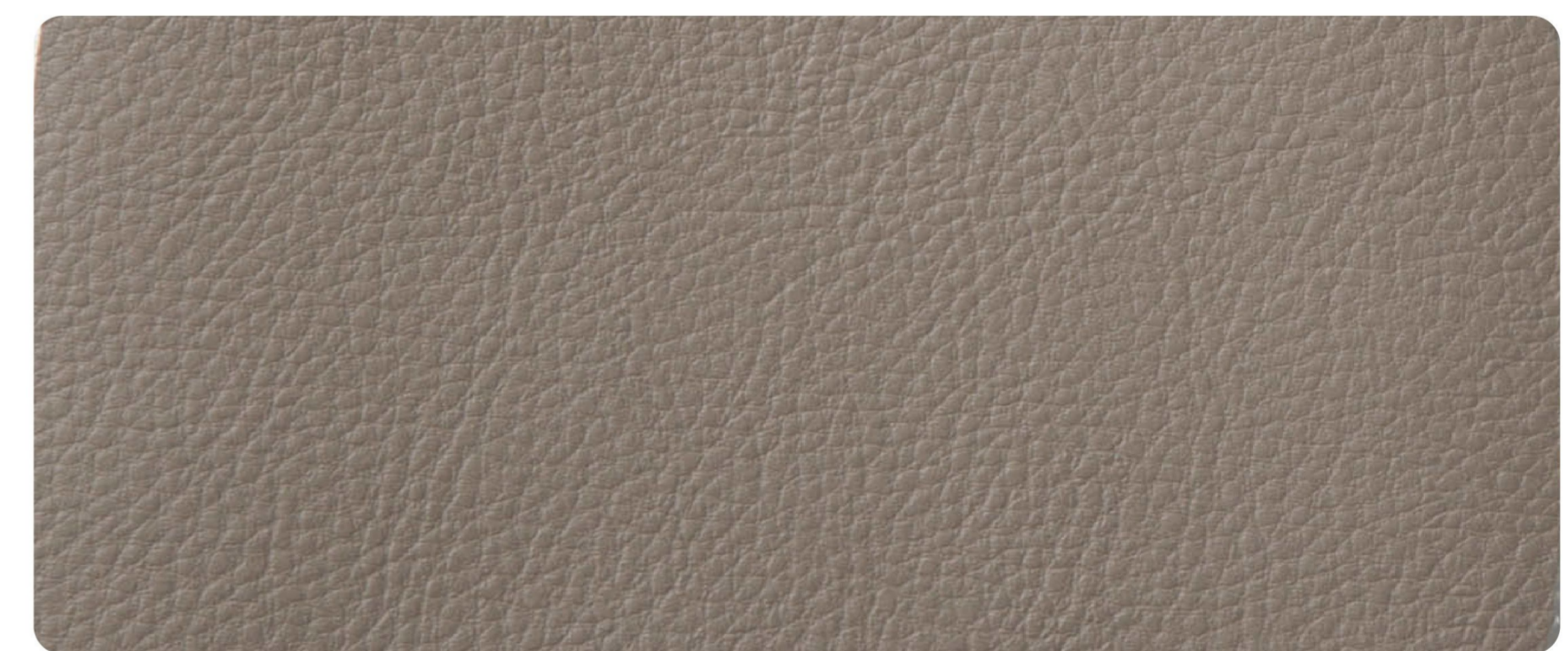

 72 x 53 x 97 cm.

 24 kg.