

HOT AIR HAND DRYER WP1200



298 x 396 x 150 mm

- Hot air hand dryer in robust, germ-reducing and easy-care stainless steel (AISI 304).
- All-stainless steel housing; all corners fully welded, visible surfaces satin finished and brushed with tapered glossy surface at the bottom. Further available surfaces: see below.
- Touch-free, low-failure capacitive sensor technology, sensor distance 0–30 cm, power cut-off after 30 s drying time.
- Low noise.
- SEV-tested and certified.
- Supply voltage 230 V, 50 Hz
Power rating 2000 Watt
Heater power 1915 Watt
Motor power 85 Watt
Air output 258 m³/h
- Blower unit can be replaced as module.
- Installation dimensions: 300 x 398 x 65 mm
- Mounting: With four screws in wall opening through fixing holes in the side walls.
- Delivery includes fixing material and device plug.
- Weight, including single package: 6.9 kg



Suggested text for specifications:

Hot air hand dryer in stainless steel (AISI 304) for flush mounting. All-stainless steel housing; all corners fully welded, visible surfaces satin finished and brushed with tapered glossy surface at the bottom. Low noise blower unit with capacitive sensor technology, sensor distance 0-30 cm, drying time 30 s factory setting, can be replaced as module. Power rating 2000 W. SEV-tested and certified. Delivery includes fixing material and device plug, mains cable supply on site 230 V/50 Hz.

Dimensions: 298 x 396 x 150 mm

Article No. WP1200

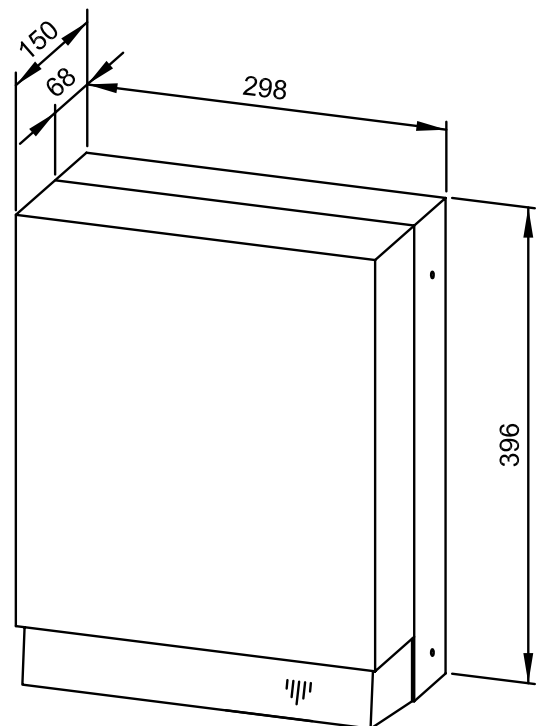

Available surfaces	ID No.
satin finished (standard)	733 020
highly polished	731 020
(coloured) plastic powder-coating	728 020

Ernst Wagner GmbH & Co. KG

Ernst-Abbe-Straße 21 · D-72770 Reutlingen · Tel.: +49712151539-0 · Fax: -20
info@wagner-ewar.de · www.wagner-ewar.de

WAGNER
EWAR