

Features

- Integral apron.
- Safeguard® slip-resistant surface on bath floor.
- Coordinates with other products in the Memoirs collection.

Material

- KOHLER® enameled cast iron.

Installation

- Right drain.
- Alcove.

Recommended Products/Accessories

- K-7161-AF 1-1/2" adjustable pop-up drain above- or through-floor
- K-7259 Clearflo Bath Drain
- K-702200-G54 Frameless Sliding Bath Door
- K-702200-G73 Frameless Sliding Bath Door
- K-702200-L Frameless Sliding Bath Door
- K-702205-L Frameless Sliding Bath Door
- K-706000-D3 Frameless Sliding Bath Door
- K-706000-L Frameless Sliding Bath Door
- K-706003-L Frameless Sliding Bath Door
- K-706004-D3 Frameless Sliding Bath Door
- K-706004-L Frameless Sliding Bath Door
- K-706007-L Frameless Sliding Bath Door
- K-23726 Drain treatment
- K-23725 Cast iron cleaner



ADA

Codes/Standards







ASME A112.19.1/CSA B45.2
ASTM F462
ADA
ICC/ANSI A117.1

KOHLER® Enameled Cast Iron Bath and Shower Base Lifetime Limited Warranty

See website for detailed warranty information.

Available Colors/Finishes

Color tiles intended for reference only.

Color	Code	Description
	0	White
	96	Biscuit
	47	Almond
	NY	Dune
	G9	Sandbar
	K4	Cashmere

No change in measurements if connected with drain illustrated. (K-7161-AF)

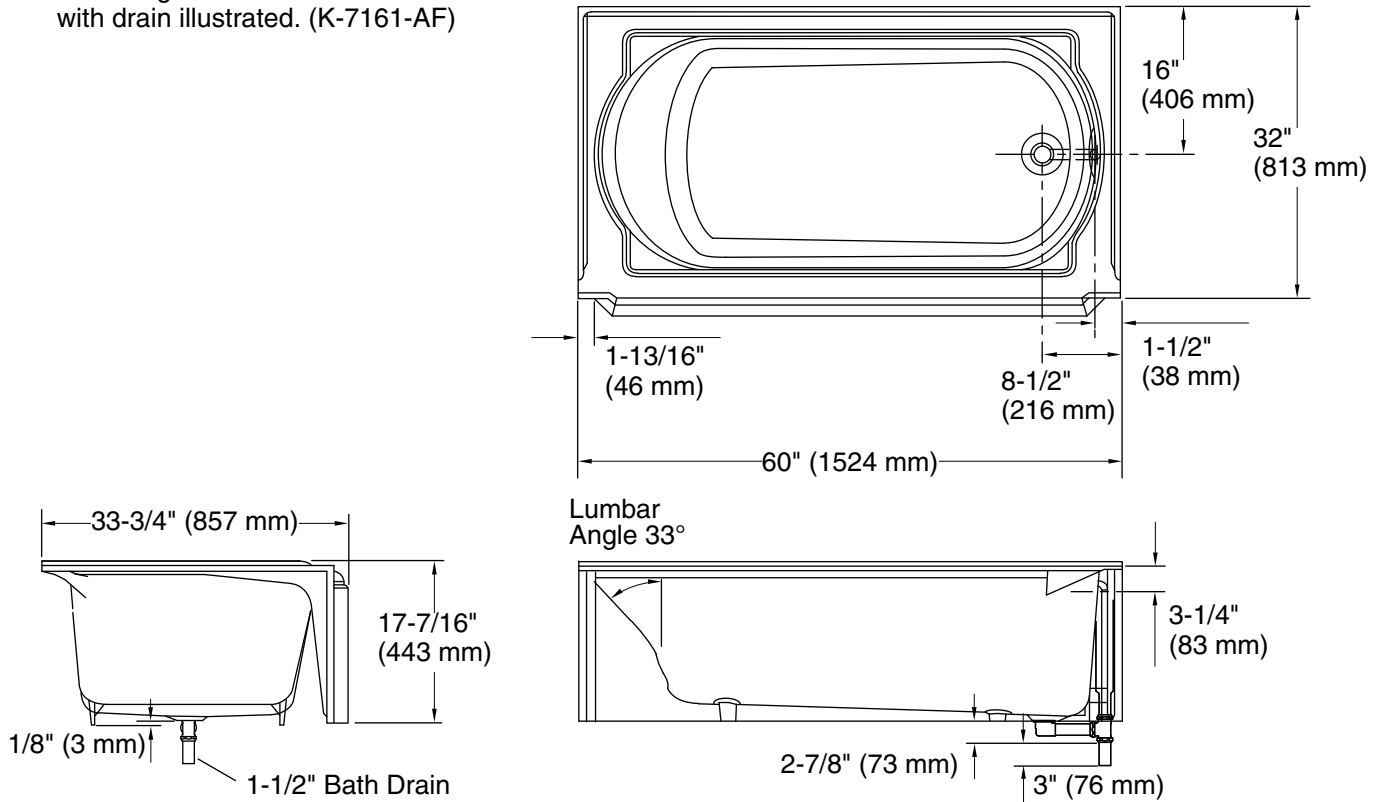

Technical Information

All product dimensions are nominal.

Installation:	Three-wall alcove
Drain location:	Right
Basin area, bottom:	45" x 23" (1143 mm x 584 mm)
Basin area, top:	54" x 25" (1372 mm x 635 mm)
Weight:	390 lbs (176.9 kg)
Minimum floor load:	61 lbs/ft ² (297.8 kg/m ²)
Water depth:	11-5/8" (295 mm)
Water capacity:	52 gal (196.8 L)
Minimum flat for door:	2" (51 mm)

Notes

- Measure your actual product for rough-in details. Install this product according to the installation instructions.
- The hot water supply should be 70% of the capacity of the bath or greater. Installations will vary.
- ADA compliant when installed to the specific requirements of these regulations.