

# GAIA

ITALIAN BATHROOM DESIGN



Rubinetti - Complementi - **RB19846**

## Scheda Tecnica-Technical Scheme

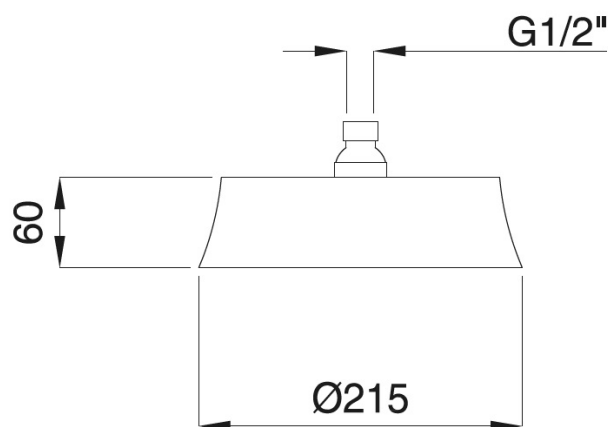

**GAIA Srl**

Via Statale 467, 153 - 42013 S. Antonino di Casalgrande (RE) - Italia - P.Iva 02827180361  
Tel. (0039) 0536 894850 - Fax 0536 894851 - [gaia@gaiamobili.it](mailto:gaia@gaiamobili.it) - [www.gaiamobili.it](http://www.gaiamobili.it)



#GaiaMobili