

TOILET BRUSH SET PC261



110 x 410 x 115 mm

- Toilet brush set in robust, germ-reducing and easy-care stainless steel (AISI 304) for surface mounting.
- Front panel with horizontal rounded edges. Visible surfaces satin finished and brushed. Further available surfaces: see below.
- Brush head replaceable.
- Cup with reservoir in polypropylene, removable.
- Mounting: With four screws through key holes and one optional anti-theft hole.
- Delivery includes fixing material.
- Weight, including single package: 1.0 kg



Suggested text for specifications:

Toilet brush set in stainless steel (AISI 304) for surface mounting. Front panel with horizontal rounded edges. Visible surfaces satin finished and brushed. Brush head replaceable, cup with reservoir in polypropylene, removable. Delivery includes fixing material.

Dimensions: 110 x 410 x 115 mm

Article No. PC261

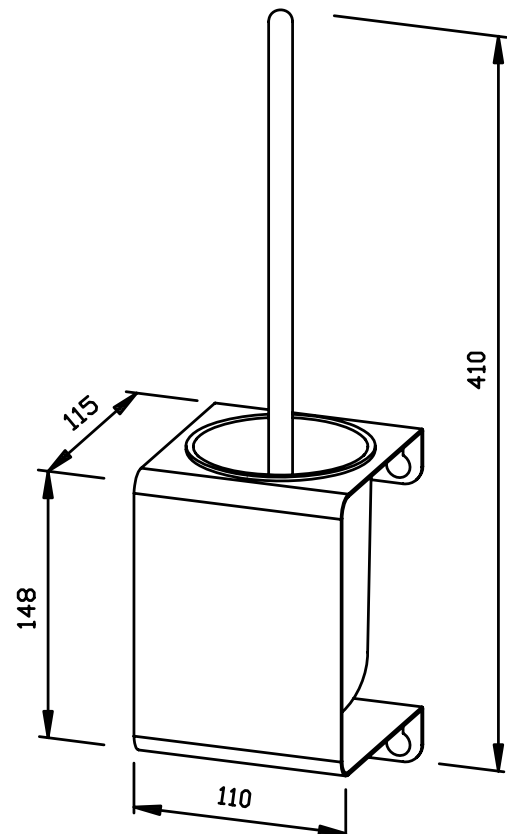

Available surfaces	ID No.
satin finished (standard)	720 261
highly polished	735 261

Ernst Wagner GmbH & Co. KG

Ernst-Abbe-Straße 21 · D-72770 Reutlingen · Tel.: +49712151539-0 · Fax: -20
info@wagner-ewar.de · www.wagner-ewar.de

WAGNER
EWAR