

Lever handle L



Knud Holscher collection

Product 14L, pair, 8x8mm, snap-on cover, cc 30/38mm, 33-59mm.

Tender text Knud Holscher collection, lever handle 14L pair, 8x8mm, snap-on cover, cc 30/38mm, 33-59mm. Manufactured in the highest quality marine grade, AISI 316 stainless steel, protecting against high levels of corrosion. Unique ball bearing system to secure extraordinary long lifespan. Certified in accordance with EN 1906 to 47-B1140U. Fire tested in accordance with EN 1634. 20-year warranty.

Product specification Dimensions: 135x50x49mm
Diameter: Ø14mm
Material: stainless steel AISI 316
Surface finish: satin grain 320, crafted by hand
[20-year warranty \(5 years for coated items\)](#)

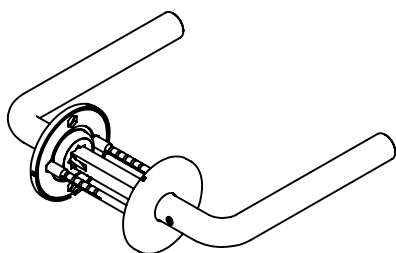
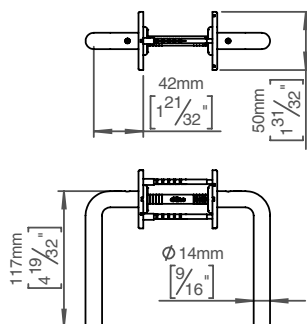

Available finishes



Spare parts/ accessories

14970102016 - Grub screw M5x6,8mm
14296174107 - Sectioned bolt set M4x110mm with bush
14281092092 - Spindle for door 33-59mm
14976700105 - TX10 tool kit
14293002002 - Snap-on cover tool

Mounting

<https://dline.com/mounting-instructions/>

Product care

d line products are produced in the highest quality marine grade AISI 316 stainless steel. To sustain the unique d line finish please follow the below instructions:

- Wash down the surfaces using soapy water or mild detergent
- Always thoroughly rinse off with clean water
- To complete the cleaning procedure dry/polish the surface with a soft dry cloth

Please do not use scouring powder, steel wool, chloride based detergents or other aggressive cleaning products as these may damage the surface.

If spots or corrosion appear on the surface it is not due to the stainless steel quality, but to impurities in the environment, aggressive conditions or improper or insufficient cleaning.