

FOLK by Rafa García, 2011

SANCAL



EXPLICACION DEL MODELO

Más es mejor. Más respaldo, más suave, más madera, más pequeño, más redondo, más confortable, más detalles, más práctico, más popular.

El último proyecto de Rafa García cubre todas nuestras expectativas. Como su nombre indica, Folk es una propuesta popular en todos los sentidos: precio competitivo, máxima comodidad, medidas muy ajustadas, artesanía y reminiscencias vintage.

La comodidad ha sido una prioridad en el desarrollo del modelo. Gracias a la suavidad de sus almohadas, las proporciones del respaldo y su altura, hemos conseguido crear una sentada que te abraza y te permite recostar la cabeza sin necesidad de recurrir a ningún mecanismo.

La colección está compuesta por 4 sofás con y sin orejas, 1 chaise con y sin oreja, 1 ángulo, 4 módulos y 3 pufs. La opción con orejas da carácter al diseño y potencia su comodidad.

Para los respaldos y los pufs Rafa ha creado una funda opcional con un delicado acolchado que podemos incorporar a cualquier pieza.

Las almohadas de asiento y respaldo están unidas por la parte interior mediante una cremallera, ello contribuye a que ambas almohadas se adapten mejor al sentarnos y también a mantenerlas ordenadas.

Para aunar bienestar y durabilidad, el núcleo de las almohadas de asiento ha sido confeccionado con distintas densidades de espuma de poliuretano, mientras que la capa externa es de FiberDream (una micro-fibra tacto pluma). Las almohadas de respaldo, confeccionadas exclusivamente con FiberDream, son ultra-soft. Todo ello nos proporciona una sentada extra confortable.

Las patas, de madera de haya, están disponibles en natural, nogal, antracita o wengué plus.

La unión de módulos se realiza mediante carracas.

Folk se puede tapizar en tela, piel o piel sintética. Tapizado en tela es desenfundable en su totalidad; en piel o piel sintética sólo son desenfundables las almohadas.

DESCRIPTION OF THE MODEL

More is better. More backrest, softer, more wood, smaller, rounder, more comfortable, more detail, more practical and more popular.

The latest project by Rafa García lives up to all our expectations. As its name suggests, Folk is a popular model in every way: competitive price, maximum comfort, tight measurements, crafts and vintage accents.

Comfort has been a priority in developing the model. Thanks to the softness of the pillows, the proportions of the back and its height, we managed to create a seat that hugs you and lets you lay the head without needing any mechanism.

The collection consists of 4 sofas with and without wings, 1 chaise with and without wings, 4 modules and 3 poufs. The option with wings gives personality to this design and enhances its comfort.

For backs and poufs, Rafa has created an optional quilted cover which can be incorporated into any of the pieces.

The seat and back cushions are joined by a zip - this holds them together when sat on and keeps them tidy.

In order to join comfort with durability, the seat cushions combine various densities of polyurethane foam with an upper layer of FiberDream (feather touch microfibre). The back cushions are entirely made of FiberDream, they are ultra-soft. All this provides an extra-comfortable seat.

The beech feet are available in natural, walnut, anthracite or wengue plus.

Module joining is performed by means of a ratchet.

Folk can be upholstered in fabric, leather or synthetic leather. It has fully removable covers when upholstered in fabric; but only the cushions when the piece is upholstered in leather or synthetic leather.

CARACTERISTIQUES

Plus c'est mieux. Plus de dossier, plus de douceur, plus de bois, plus petit, plus rond, plus confortable, plus de détails, plus pratique, plus populaire.

Le dernier projet de Rafa Garcia comble toutes nos attentes. Comme son nom l'indique, Folk est une proposition populaire dans tous les sens: prix compétitifs, confort maximum, dimensions très ajustées, artisanat et réminiscence vintage.

Le confort, a été une recherche constante lors de la conception du modèle. Grâce à la souplesse des coussins, les proportions du dossier et sa hauteur, nous avons réussi à créer une assise qui enveloppe et permet de reposer la nuque sans faire appel à un mécanisme.

La collection se compose de 4 canapés avec ou sans extensions, 1 chaise longue avec ou sans extension, 1 angle, 4 modules et 3 poufs. L'option avec extension donne un caractère particulier au design et potentialise son confort.

Pour les dossiers et les poufs, Rafa a créé une housse en option avec un matelassage subtil qui peut être incorporé à tous les modules.

Les coussins d'assise et de dossier sont unis dans la partie intérieure par une fermeture éclair. Ceci contribue à leur maintien et s'adapteront encore mieux à votre assise.

Pour conjuguer bien-être et durabilité, le noyau des coussins d'assise a été réalisé avec différentes densités de mousse de polyuréthane, tandis que la couche externe est en FiberDream (microfibre, touché plumes). Les coussins de dossier, sont confectionnés exclusivement avec FiberDream, ultra-soft. Tous ces éléments procurent une assise extra confortable.

Les pieds sont en hêtre et son disponibles en naturel, noyer, anthracite ou wengé plus.

Les modules sont réunis par un système d'ancrage.

Folk est réalisable en tissu, cuir ou cuir synthétique. Il est complètement déhoussable en tissu; par contre, en cuir ou cuir synthétique ne sont déhoussables que les coussins, la base est fixe.

FOLK by Rafa García, 2011

SANCAL

IMPORTANTE

Para el buen mantenimiento de las almohadas recomendamos agitarlas energicamente una vez por semana. Ello evita que la micro-fibra se apelmace.

Folk se sirve montado en una pieza y no es desmontable. De forma excepcional y siempre que el cliente lo solicite previamente, algunas piezas se podrán fabricar para que sean desmontables en destino, cuando vayan tapizadas en tela. Estas piezas son: el sofá orejero de 240, el sofá de 228 y los módulos de 210.

Las solicitudes de composiciones modulares deben adjuntar un plano en planta al realizar el pedido. La mano (derecha/izquierda) se interpreta siempre viendo el dibujo de frente.

IMPORTANT

For the proper maintenance of the cushions we recommend one shakes them vigorously once a week. This prevents the micro-fibre clumping.

Folk is delivered assembled and cannot be disassembled. Exceptionally, and only if requested previously by the customer, some pieces may be manufactured to be disassembled at the destination, but only when upholstered in fabric. These pieces are: 240cm sofa with wings, 228cm sofa and the 210cm modules.

Requests for modular combinations must have an attached plan when placing the order. When specifying left or right side, it is always as facing the piece.

IMPORTANT

Pour conserver le bon maintien des coussins, nous recommandons de les secouer énergiquement une fois par semaine. Ceci évite que la microfibre se tasse.

Folk est livré en une seule pièce et n'est pas démontable. Exceptionnellement avec une demande préalable du client, certaines pièces pourront se fabriquer en version démontable, mais exclusivement en tissu. Ces modules sont: le canapé avec extension, de 240cm, le canapé 228cm et les modules de 210cm.

Les commandes de compositions modulaires doivent être accompagnées d'un plan. Le bras droit (droit/gauche) s'interprète toujours face au module.

CARACTERISTICAS TECNICAS

TELA

- Estructura y almohadas totalmente desfundables.
- Estructura de madera recubierta de espuma HR Ultracel de 30kg y fibra de 100gr con velour.
- Bastidor de asiento preparado con cincha NEA de 80mm.
- Bastidor de respaldo preparado con cincha NEA de 60mm y confeccionado con espuma HR Ultracel de 30kg y HRSS Ultracel de 30kg.
- Brazos: estructura de madera confeccionada con espuma de 60kg, HR Ultracel de 30kg, y HRSS Ultracel de 30kg.
- Almohada de asiento: espuma HR Ultracel de 30kg revestida por una funda de algodón acolchada con FiberDream (microfibra tacto pluma).
- Almohada de respaldo: funda de algodón rellena de FiberDream (microfibra tacto pluma).
- Patas: madera de haya tintada en color natural, nogal, antracita o wengué plus.
- Funda para cabezal y puf acolchada con fibra H150gr.

PIEL

- Estructura fija y almohadas desfundables.
- La funda para cabezal y puf no se realiza en piel.
- El resto de características son idénticas a las de la versión tapizada en tela.

PATAS: ACABADOS Y COLORES / FEET: FINISHES AND COLOURS / PIEDS: COULEUR

HAYA / BEECH / HÊTRE Tintes / Stains / Teinture



002 030 003 006

TECHNICAL CHARACTERISTICS

FABRIC

- Totally removable base and cushion covers.
- Wooden structure with HR 30kg Ultracel foam shell and 100g fibre with felt.
- Seat structure fitted with 80mm NEA webbing.
- Back structure fitted with 60mm NEA webbing with 30kg HR Ultracel foam and 30kg HRSS Ultracel.
- Arms: wooden structure fitted with 60kg foam, 30kg HR Ultracel, and 30kg HRSS Ultracel.
- Seat cushion: 30kg HR Ultracel foam covered with a cotton cover filled with FiberDream (feather touch microfibre).
- Back cushion: cotton cover filled with FiberDream (feather touch microfibre).
- Feet: natural beech, stained in natural, walnut, anthracite or wengue-plus.
- Cover for headrest and pouf quilted with H150gr fibre.

LEATHER

- Fixed structure and removable cushion covers.
- The cover for headrest and pouf cannot be made in leather.
- The remaining technical specifications are the same as those for the fabric version of the product.

CARACTERISTIQUES TECHNIQUES

TISSU

- 100% déhoussable.
- Structure en bois recouvert de mousse HR Ultracel de 30kg et fibre de 100gr avec velours.
- Châssis d'assise préparé avec des sangles NEA de 80mm.
- Châssis de dos préparé avec des sangles NEA de 60mm et mousse HR Ultracel de 30kg et mousse HRSS Ultracel de 30kg.
- Bras: structure en bois recouverte de mousses de 60kg, HR Ultracel de 30kg et HRSS Ultracel de 30kg.
- Coussin d'assise: mousse HR Ultracel de 30kg recouvert d'une housse coton capitonnée de FiberDream (microfibre toucher duvet).
- Coussin de dossier: housse coton avec FiberDream (microfibre toucher duvet).
- Pieds: en hêtre teinté naturel, noyer, anthracite ou wengue plus.
- Housse de tête et de pouf, capitonnée avec fibre de 150gr.

CUIR

- Structure fixe et coussins déhoussables.
- Housse de tête et de pouf non réalisable en cuir.
- Le reste des caractéristiques techniques est identique à la version tissu.

FOLK by Rafa García, 2011

SANCAL

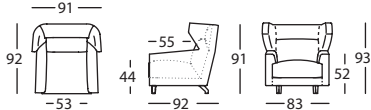

SILLÓN OREJERO
WING ARMCHAIR
FAUTEUIL À OREILLES

269.11.K.R

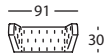

FUNDA CABEZAL SILLÓN OREJERO
HEADREST COVER WING ARMCHAIR
HOUSSE TÊTIÈRE FAUTEUIL À OREI-
LLES

269.35.K.R

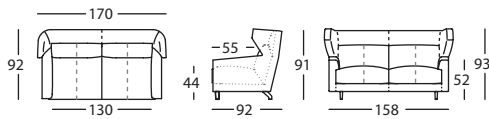

SOFÁ OREJERO 170
WING SOFA 170
CANAPE À OREILLES 170

269.11.S.R

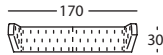

FUNDA CABEZAL SOFÁ OREJERO 170
HEADREST COVER WING SOFA 170
HOUSSE TÊTIÈRE CANAPE À OREILLES
170

269.35.S.R

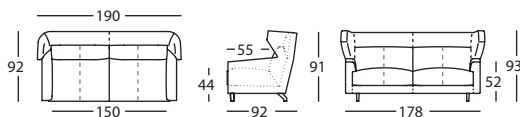

SOFÁ OREJERO 190
WING SOFA 190
CANAPE À OREILLES 190

269.11.U.R

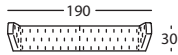

FUNDA CABEZAL SOFÁ OREJERO 190
HEADREST COVER WING SOFA 190
HOUSSE TÊTIÈRE CANAPE À OREILLES
190

269.35.U.R

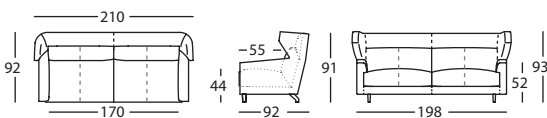

SOFÁ OREJERO 210
WING SOFA 210
CANAPE À OREILLES 210

269.11.W.R

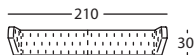

FUNDA CABEZAL SOFÁ OREJERO 210
HEADREST COVER WING SOFA 210
HOUSSE TÊTIÈRE CANAPE À OREILLES
210

269.35.W.R

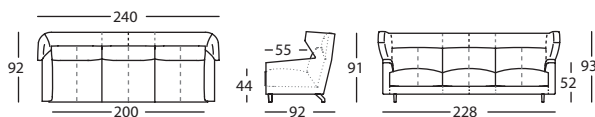

SOFÁ OREJERO 240
WING SOFA 240
CANAPE À OREILLES 240

269.11.Z.R

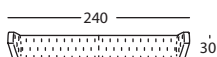

FUNDA CABEZAL SOFÁ OREJERO 240
HEADREST COVER WING SOFA 240
HOUSSE TÊTIÈRE CANAPE À OREILLES
240

269.35.Z.R

FOLK by Rafa García, 2011

SANCAL

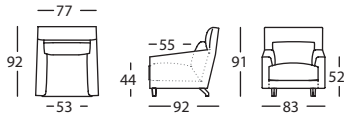

SILLÓN
ARMCHAIR
FAUTEUIL **269.11.J.5**



FUNDA CABEZAL SILLÓN
HEADREST COVER ARMCHAIR
HOUSSE TÊTIÈRE FAUTEUIL **269.35.J.5**

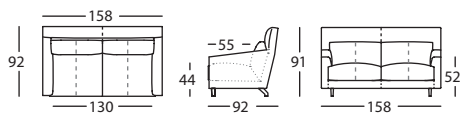

SOFÁ 158
SOFA 158
CANAPE 158 **269.11.R.5**

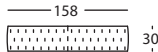

FUNDA CABEZAL SOFÁ 158
HEADREST COVER SOFA 158
HOUSSE TÊTIÈRE CANAPE 158 **269.35.R.5**

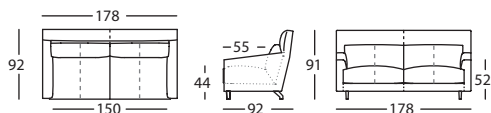

SOFÁ 178
SOFA 178
CANAPE 178 **269.11.T.5**

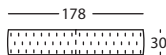

FUNDA CABEZAL SOFÁ 178
HEADREST COVER SOFA 178
HOUSSE TÊTIÈRE CANAPE 178 **269.35.T.5**

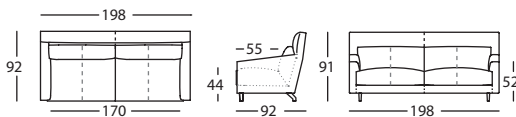

SOFÁ 198
SOFA 198
CANAPE 198 **269.11.V.5**

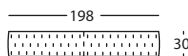

FUNDA CABEZAL SOFÁ 198
HEADREST COVER SOFA 198
HOUSSE TÊTIÈRE CANAPE 198 **269.35.V.5**

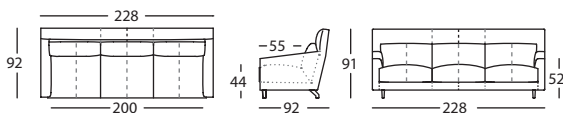

SOFÁ 228
SOFA 228
CANAPE 228 **269.11.Y.5**

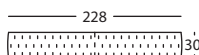

FUNDA CABEZAL SOFÁ 228
HEADREST COVER SOFA 228
HOUSSE TÊTIÈRE CANAPE 228 **269.35.Y.5**

FOLK by Rafa García, 2011

SANCAL

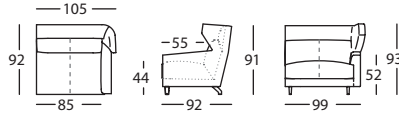

MODULO 90 BR OREJERO DCHO
MODULE 90 WING RIGHT ARM
MODULE 90 BRAS À OREILLE DROIT **269.122.K.R.D**

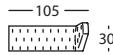

FUNDA CABEZAL MOD 90 BR OREJERO DCHO
HEADREST COVER MOD 90 WING RIGHT ARM
HOUSSE TÊTIÈRE MOD 90 BRAS À OREILLE DROIT **269.35.K.R.D**

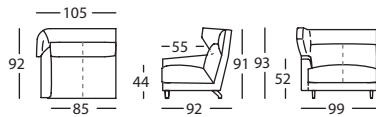

MODULO 90 BR OREJERO IZDO
MODULE 90 WING LEFT ARM
MODULE 90 BRAS À OREILLE GAUCHE **269.122.K.R.I**

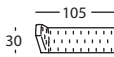

FUNDA CABEZAL MOD 90 BR OREJERO IZDO
HEADREST COVER MOD 90 WING LEFT ARM
HOUSSE TÊTIÈRE MOD 90 BRAS À OREILLE GAUCHE **269.35.K.R.I**

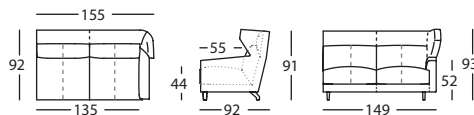

MODULO 140 BR OREJERO DCHO
MODULE 140 WING RIGHT ARM
MODULE 140 BRAS À OREILLE DROIT **269.122.Q.R.D**

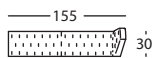

FUNDA CABEZAL MOD 140 BR OREJERO DCHO
HEADREST COVER MOD 140 WING RIGHT ARM
HOUSSE TÊTIÈRE MOD 140 BRAS À OREILLE DROIT **269.35.Q.R.D**

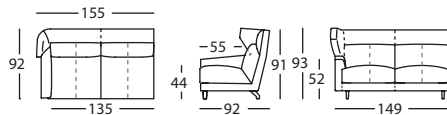

MODULO 140 BR OREJERO IZDO
MODULE 140 WING LEFT ARM
MODULE 140 BRAS À OREILLE GAUCHE **269.122.Q.R.I**

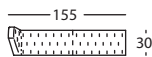

FUNDA CABEZAL MOD 140 BR OREJERO IZDO
HEADREST COVER MOD 140 WING LEFT ARM
HOUSSE TÊTIÈRE MOD 140 BRAS À OREILLE GAUCHE **269.35.Q.R.I**

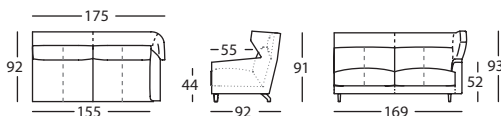

MODULO 160 BR OREJERO DCHO
MODULE 160 WING RIGHT ARM
MODULE 160 BRAS À OREILLE DROIT **269.122.S.R.D**

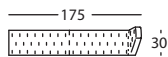

FUNDA CABEZAL MOD 160 BR OREJERO DCHO
HEADREST COVER MOD 160 WING RIGHT ARM
HOUSSE TÊTIÈRE MOD 160 BRAS À OREILLE DROIT **269.35.S.R.D**

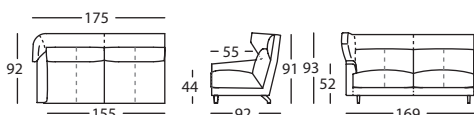

MODULO 160 BR OREJERO IZDO
MODULE 160 WING LEFT ARM
MODULE 160 BRAS À OREILLE GAUCHE **269.122.S.R.I**

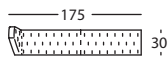

FUNDA CABEZAL MOD 160 BR OREJERO IZDO
HEADREST COVER MOD 160 WING LEFT ARM
HOUSSE TÊTIÈRE MOD 160 BRAS À OREILLE GAUCHE **269.35.S.R.I**

FOLK by Rafa García, 2011

SANCAL

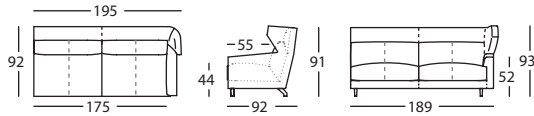

MODULO 180 BR OREJERO DCHO
MODULE 180 WING RIGHT ARM
MODULE 180 BRAS À OREILLE DROIT

269.122.U.R.D

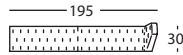

FUNDA CABEZAL MOD 180 BR OREJERO DCHO
HEADREST COVER MOD 180 WING RIGHT ARM
HOUSSE TÊTIÈRE MOD 180 BRAS À OREILLE DROIT

269.35.U.R.D

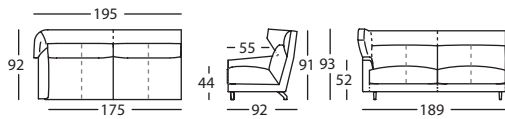

MODULO 180 BR OREJERO IZDO
MODULE 180 WING LEFT ARM
MODULE 180 BRAS À OREILLE GAUCHE

269.122.U.R.I

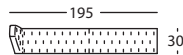

FUNDA CABEZAL MOD 180 BR OREJERO IZDO
HEADREST COVER MOD 180 WING LEFT ARM
HOUSSE TÊTIÈRE MOD 180 BRAS À OREILLE GAUCHE

269.35.U.R.I

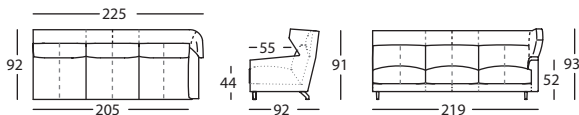

MODULO 210 BR OREJERO DCHO
MODULE 210 WING RIGHT ARM
MODULE 210 BRAS À OREILLE DROIT

269.122.X.R.D

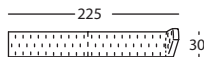

FUNDA CABEZAL MOD 210 BR OREJERO DCHO
HEADREST COVER MOD 210 WING RIGHT ARM
HOUSSE TÊTIÈRE MOD 210 BRAS À OREILLE DROIT

269.35.X.R.D

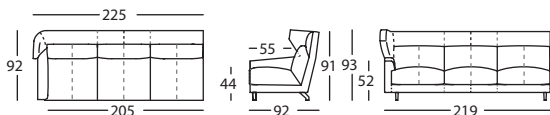

MODULO 210 BR OREJERO IZDO
MODULE 210 WING LEFT ARM
MODULE 210 BRAS À OREILLE GAUCHE

269.122.X.R.I

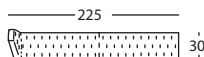

FUNDA CABEZAL MOD 210 BR OREJERO IZDO
HEADREST COVER MOD 210 WING LEFT ARM
HOUSSE TÊTIÈRE MOD 210 BRAS À OREILLE GAUCHE

269.35.X.R.I

FOLK by Rafa García, 2011

SANCAL

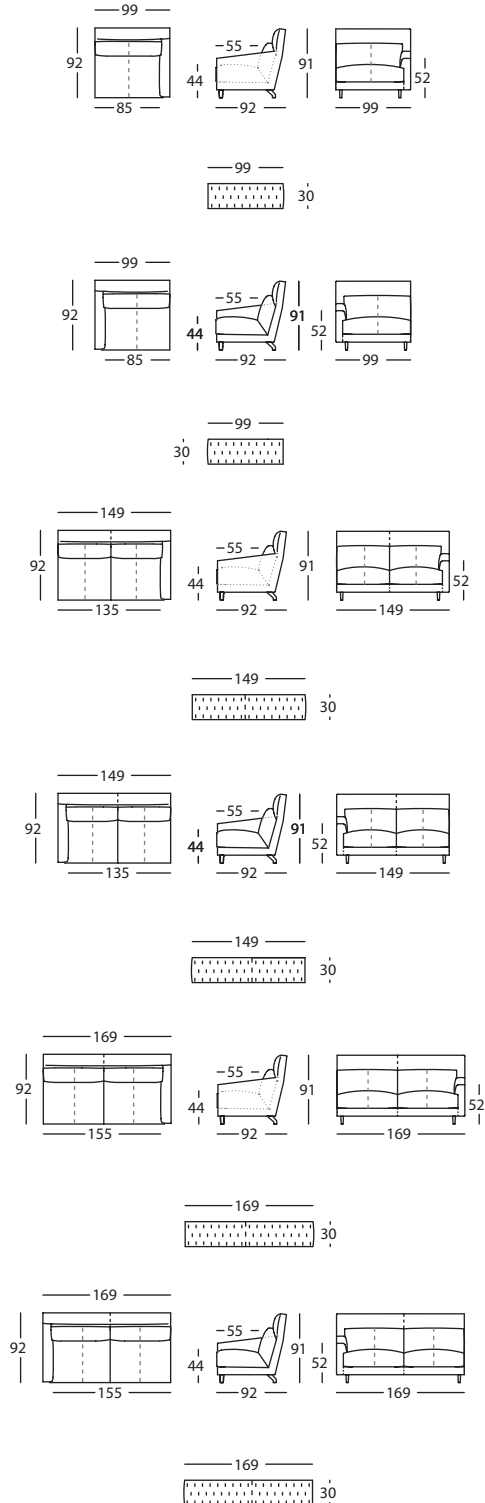

MODULO 90 BR DCHO
MODULE 90 RIGHT ARM
MODULE 90 BRAS DROIT **269.122.K.5.D**

FUNDA CABEZAL MOD 90 BR DCHO
HEADREST COVER MOD 90 RIGHT ARM
HOUSSE TÊTIÈRE MOD 90 BRAS DROIT **269.35.K.5.D**

MODULO 90 BR IZDO
MODULE 90 LEFT ARM
MODULE 90 BRAS GAUCHE **269.122.K.5.I**

FUNDA CABEZAL MOD 90 BR IZDO
HEADREST COVER MOD 90 LEFT ARM
HOUSSE TÊTIÈRE MOD 90 BRAS GAUCHE **269.35.K.5.I**

MODULO 140 BR DCHO
MODULE 140 RIGHT ARM
MODULE 140 BRAS DROIT **269.122.Q.5.D**

FUNDA CABEZAL MOD 140 BR DCHO
HEADREST COVER MOD 140 RIGHT ARM
HOUSSE TÊTIÈRE MOD 140 BRAS DROIT **269.35.Q.5.D**

MODULO 140 BR IZDO
MODULE 140 LEFT ARM
MODULE 140 BRAS GAUCHE **269.122.Q.5.I**

FUNDA CABEZAL MOD 140 BR IZDO
HEADREST COVER MOD 140 LEFT ARM
HOUSSE TÊTIÈRE MOD 140 BRAS GAUCHE **269.35.Q.5.I**

MODULO 160 BR DCHO
MODULE 160 RIGHT ARM
MODULE 160 BRAS DROIT **269.122.S.5.D**

FUNDA CABEZAL MOD 160 BR DCHO
HEADREST COVER MOD 160 RIGHT ARM
HOUSSE TÊTIÈRE MOD 160 BRAS DROIT **269.35.S.5.D**

MODULO 160 BR IZDO
MODULE 160 LEFT ARM
MODULE 160 BRAS GAUCHE **269.122.S.5.I**

FUNDA CABEZAL MOD 160 BR IZDO
HEADREST COVER MOD 160 LEFT ARM
HOUSSE TÊTIÈRE MOD 160 BRAS GAUCHE **269.35.S.5.I**

FOLK by Rafa García, 2011

SANCAL

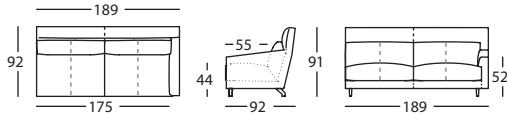

MODULO 180 BR DCHO
MODULE 180 RIGHT ARM
MODULE 180 BRAS DROIT **269.122.U.5.D**

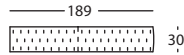

FUNDA CABEZAL MOD 180 BR DCHO
HEADREST COVER MOD 180 RIGHT
ARM
HOUSSE TÊTIÈRE MOD 180 BRAS
DROIT **269.35.U.5.D**

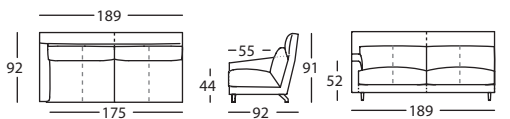

MODULO 180 BR IZDO
MODULE 180 LEFT ARM
MODULE 180 BRAS GAUCHE **269.122.U.5.I**

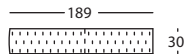

FUNDA CABEZAL MOD 180 BR IZDO
HEADREST COVER MOD 180 LEFT
ARM
HOUSSE TÊTIÈRE MOD 180 BRAS
GAUCHE **269.35.U.5.I**

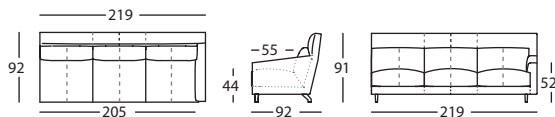

MODULO 210 BR DCHO
MODULE 210 RIGHT ARM
MODULE 210 BRAS DROIT **269.122.X.5.D**

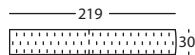

FUNDA CABEZAL MOD 210 BR DCHO
HEADREST COVER MOD 210 RIGHT
ARM
HOUSSE TÊTIÈRE MOD 210 BRAS
DROIT **269.35.X.5.D**

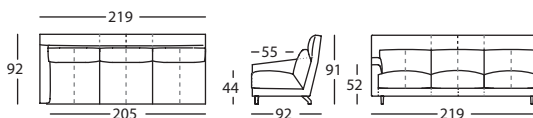

MODULO 210 BR IZDO
MODULE 210 LEFT ARM
MODULE 210 BRAS GAUCHE **269.122.X.5.I**

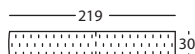

FUNDA CABEZAL MOD 210 BR IZDO
HEADREST COVER MOD 210 LEFT
ARM
HOUSSE TÊTIÈRE MOD 210 BRAS
GAUCHE **269.35.X.5.I**

FOLK by Rafa García, 2011

SANCAL

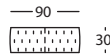
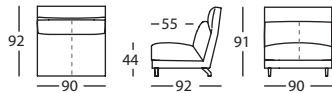

MODULO 90
MODULE 90
MODULE 90 **269.121.K**

FUNDA CABEZAL MODULO 90
HEADREST COVER MODULE 90
HOUSSE TÊTIÈRE MODULE 90 **269.35.K**

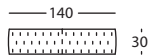
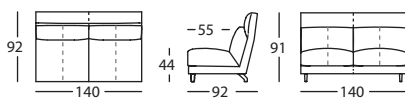

MODULO 140
MODULE 140
MODULE 140 **269.121.Q**

FUNDA CABEZAL MODULO 140
HEADREST COVER MODULE 140
HOUSSE TÊTIÈRE MODULE 140 **269.35.Q**

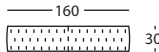
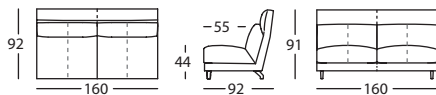

MODULO 160
MODULE 160
MODULE 160 **269.121.S**

FUNDA CABEZAL MODULO 160
HEADREST COVER MODULE 160
HOUSSE TÊTIÈRE MODULE 160 **269.35.S**

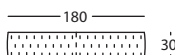
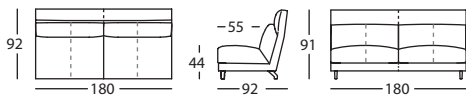

MODULO 180
MODULE 180
MODULE 180 **269.121.U**

FUNDA CABEZAL MODULO 180
HEADREST COVER MODULE 180
HOUSSE TÊTIÈRE MODULE 180 **269.35.U**

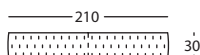
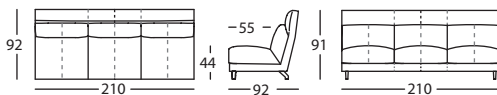

MODULO 210
MODULE 210
MODULE 210 **269.121.X**

FUNDA CABEZAL MODULO 210
HEADREST COVER MODULE 210
HOUSSE TÊTIÈRE MODULE 210 **269.35.X**

FOLK by Rafa García, 2011

SANCAL

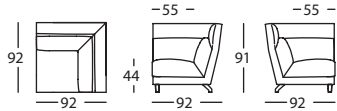

ANGULO RECTO 92X92
STRAIGHT CORNER 92X92
ANGLE 92X92

269.161

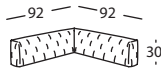

FUNDA CABEZAL ANGULO RECTO
HEADREST COVER STRAIGHT CORNER
HOUSSE TÊTIÈRE ANGLE

269.35.KK

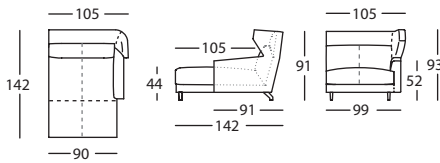

CHAISE 105X142 BR OREJERO DCHO
CHAISE 105X142 WING RIGHT ARM
CHAISE 105X142 BRAS À OREILLE DROIT

269.142.R.D

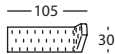

FUNDA CABEZAL CHAISE 105X142 BR OREJERO DCHO
HEADREST COVER CHAISE 105X142 WING RIGHT ARM
HOUSSE TÊTIÈRE CHAISE 105X142 BRAS À OREILLE DROIT

269.35.L.R.D

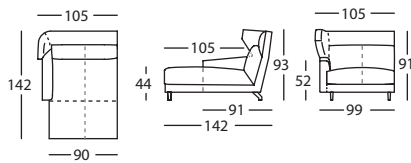

CHAISE 105X142 BR OREJERO IZDO
CHAISE 105X142 WING LEFT ARM
CHAISE 105X142 BRAS À OREILLE GAUCHE

269.142.R.I

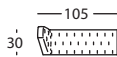

FUNDA CABEZAL CHAISE 105X142 BR OREJERO IZDO
HEADREST COVER CHAISE 105X142 WING LEFT ARM
HOUSSE TÊTIÈRE CHAISE 105X142 BRAS À OREILLE GAUCHE

269.35.L.R.I

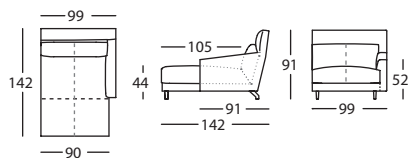

CHAISE 99X142 BRAZO DCHO
CHAISE 99X142 RIGHT ARM
CHAISE 99X142 BRAS DROIT

269.142.5.D

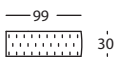

FUNDA CABEZAL CHAISE 99X142 BRAZO DCHO
HEADREST COVER CHAISE 99X142 RIGHT ARM
HOUSSE TÊTIÈRE CHAISE 99X142 BRAS DROIT

269.35.L.5.D

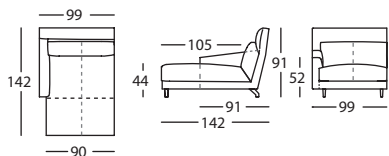

CHAISE 99X142 BRAZO IZDO
CHAISE LONGUE 99X142 LEFT ARM
CHAISE LONGUE 99X142 BRAS GAUCHE

269.142.5.I

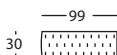

FUNDA CABEZAL CHAISE 99X142 BRAZO IZDO
HEADREST COVER CHAISE 99X142 LEFT ARM
HOUSSE TÊTIÈRE CHAISE 99X142 BRAS GAUCHE

269.35.L.5.I

FOLK by Rafa García, 2011

SANCAL

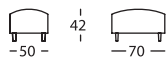

PUF 70X50
POUF 70X50
POUF 70X50

269.151.HF

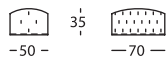

FUNDA PUF 70X50
COVER POUF 70X50
HOUSSE POUF 70X50

269.30.HF

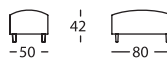
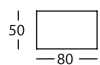

PUF 80X50
POUF 80X50
POUF 80X50

269.151.JF

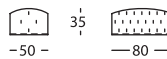

FUNDA PUF 80X50
COVER POUF 80X50
HOUSSE POUF 80X50

269.30.JF

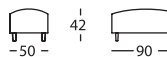
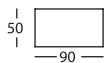

PUF 90X50
POUF 90X50
POUF 90X50

269.151.KF

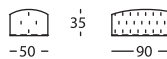

FUNDA PUF 90X50
COVER POUF 90X50
HOUSSE POUF 90X50

269.30.KF