



## ” ACCESSORI - ACCESS.



ANAC04

### ” SCHEDA TECNICA/TECHNICAL SCHEME/ТЕХНИЧЕСКИЕ СХЕМЕ:

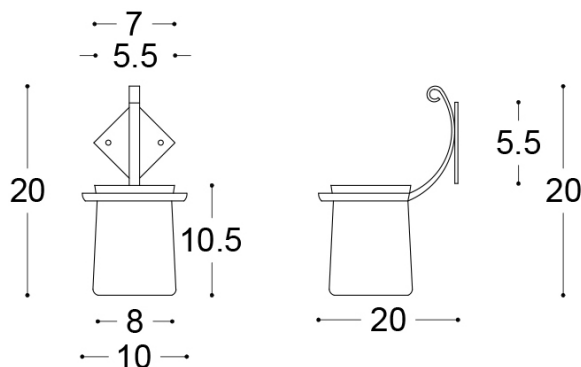

**GAIA Srl**

Via Statale 467 n°153 - 42013 S. Antonino di Casalgrande (RE) - ITALIA - P. Iva 02827180361

Tel. (0039) 0536 894850 - Fax 0536 894851 - [gaia@gaiamobili.it](mailto:gaia@gaiamobili.it) - [www.gaiamobili.it](http://www.gaiamobili.it)

