

# GAIA

ITALIAN BATHROOM DESIGN



Accessori - Lexington - AMLE05

## Scheda Tecnica-Technical Scheme

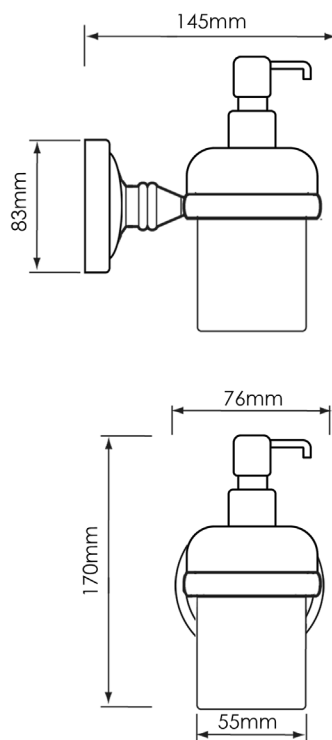

GAIA Srl

Via Statale 467, 153 - 42013 S. Antonino di Casalgrande (RE) - Italia - P.Iva 02827180361  
Tel. (0039) 0536 894850 - Fax 0536 894851 - [gaia@gaiamobili.it](mailto:gaia@gaiamobili.it) - [www.gaiamobili.it](http://www.gaiamobili.it)



#GaiaMobili