

RICAMBI / SPARE PARTS

ISTRUZIONI ELITE

Art. 884034
Art. 484028
Art. 484029
Art. 484030

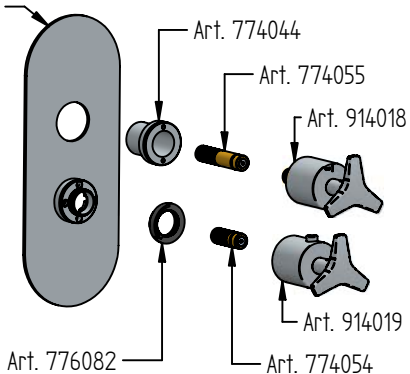

Cod. 884034



Cod. 484028



Cod. 484029



Cod. 484030

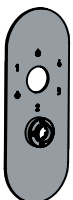

Cod. 774044



Cod. 776082



Cod. 774054



Cod. 774055



Cod. 914019



Cod. 914018



Art. 9112/H/P
Art. 9112/P

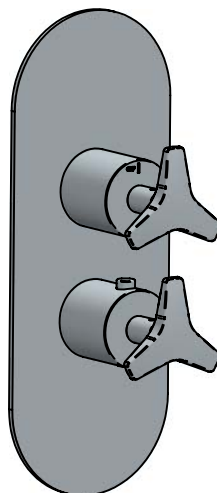

Art. 9112/2/P

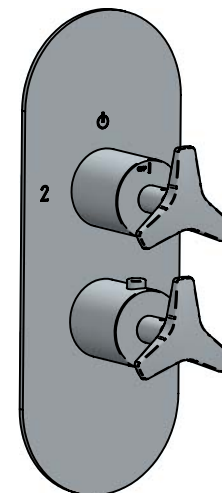

Art. 9112/3/P

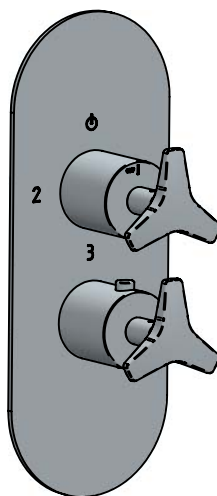

Art. 9112/4/P

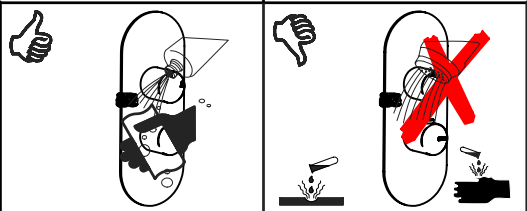
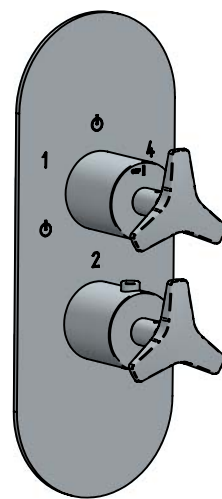

MANUTENZIONE E PULIZIA

Per una corretta manutenzione e pulizia di questo prodotto, raccomandiamo alcuni semplici accorgimenti:

- Utilizzare detergenti neutri, spruzzando il prodotto direttamente su un panno morbido onde evitare infiltrazioni
- Evitare sempre il contatto con prodotti acidi o abrasivi
- Risciacquare bene con abbondante acqua per eliminare eventuali residui ed asciugare sempre con un panno morbido
- Effettuare una pulizia periodica al fine di prevenire le formazioni calcaree

La BELLOSTA CARLO & C. non è RESPONSABILE di danni derivati dall'utilizzo di prodotti impropri per la pulizia.

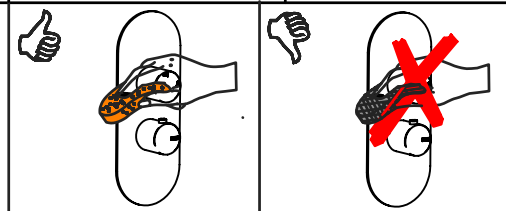

MAINTENANCE AND CLEANING

For a proper maintenance and cleaning, we recommend the following:

- Use **neutral detergents**, avoiding to spray directly on taps to avoid residual infiltration
- **Avoid** contact with acid or abrasive products
- **Rinse** with water and **always dry** with a clean cloth to avoid residue of detergent
- Perform a **periodic cleaning** to prevent limestone deposits

BELLOSTA CARLO & C. cannot be held responsible for damages due to an improper use of detergents

MADE IN ITALY

Questo prodotto è stato realizzato interamente in Italia con l'utilizzo di materie prime di altissima qualità

DESIGN
EOB

MADE IN ITALY

This product has been entirely manufactured in Italy, by top quality raw materials.



Rubinetti d'autore dedicati a te

