

Tay Thermostatic Bath Shower Mixer Wall Mounted with Swivel Shower Arm - T2WS

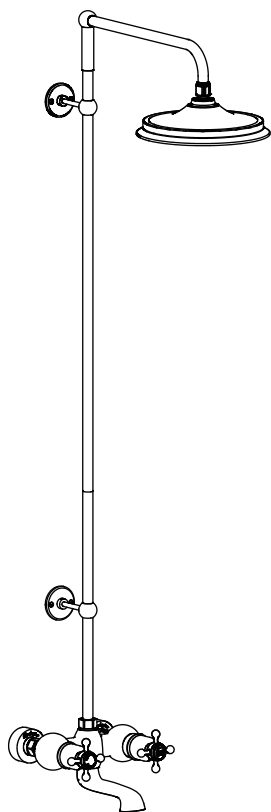

Options:

Burlington has 2 different style handles for your selection, when using these additional handles the indices will need to be utilised from the original handles.

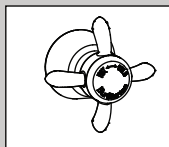

Anglesey

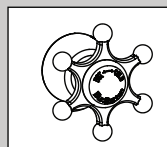

Birkenhead

NOT INCLUDED IN THE BOX

Options:

Burlington has a shower head of 3 different sizes for your selection.

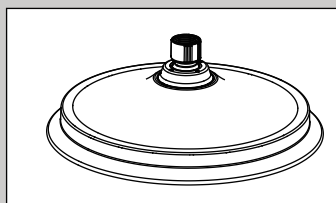

NOT INCLUDED IN THE BOX

Riser:

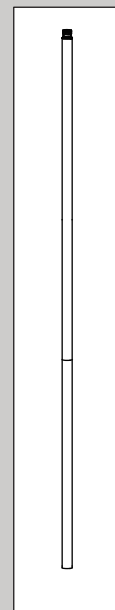

NOT INCLUDED IN THE BOX

Important

- We recommend that this product is installed by a qualified professional contractor. Such as a plumber who is certified by NVQ (National Vocational Qualification) or SNVQ (Scottish National Vocational Qualification) Level 3
- Please check this product immediately to ensure that it has not been damaged and is complete. Before installation, please make sure this product is the correct model and you have all the parts required for installation and using.
- This valve is a mixing device and therefore requires the water supplies to be reasonably balanced, otherwise we recommend a pressure reducing valve to be fitted.
- Please flush the water system to ensure that no metal swarf, solder, and other impurities can enter the valves.
- Turn off water supply before commencing work, this should be done at the isolating valves of inlet feeds if fitted or main stopcock.
- Please read these instructions carefully and keep it for future reference.

Conditions for the use of thermostatic mixing valve

The thermostatic valve has been designed to be compliant with the relevant UK standards applicable to this type of product governed by TMV2 standards and WRC. The valve is tested against BS EN 1111.

The valve will operate under low pressure but it is recommended that the minimum operating pressure is 2 bar.

- This thermostatic valve is suitable for use with all water systems up to a maximum operating pressure of 5.0 bar, (beyond which we recommend pressure reducing valves to be fitted.)
- The valve is provided with two outlets, which are controlled by a flow control cartridge. Commonly used for a main bath spout or a shower head.
- An independent, flexible hot and cold water supply pipe is recommended for use to easy maintenance.
- If installing a shower pump always install the pump before the shower valve.

The list below shows the recommended limits for correct operation;

	Low Pressure
Maximum Static Pressure – Bar	10
Flow Pressure, Hot & Cold - Bar	2 to 5
Hot Supply Temperature - °C	55 to 65
Cold Supply Temperature - °C	Equal to or less than 25°

The British Burns Association recommends 37 to 37.5°C as a comfortable bathing temperature for children. In premises covered by the Care Standards Act 2000, the maximum mixed water outlet temperature of 43°C.

Dimension

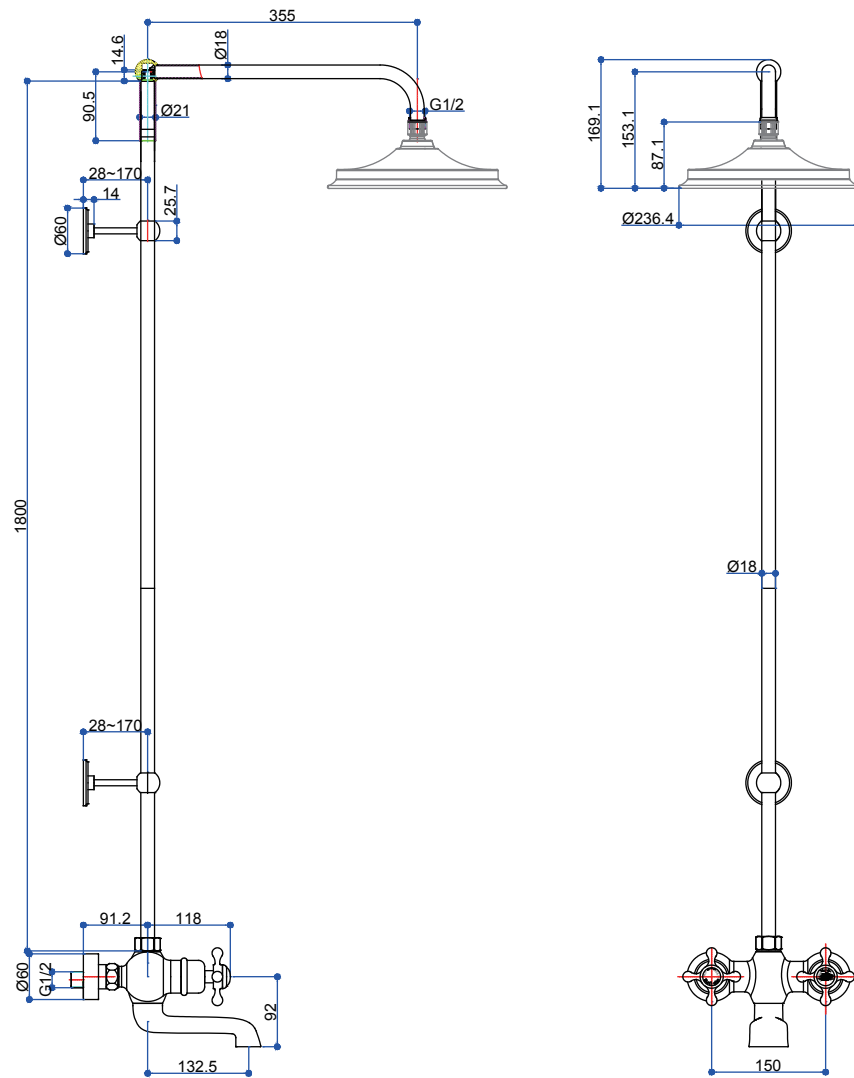

Installation

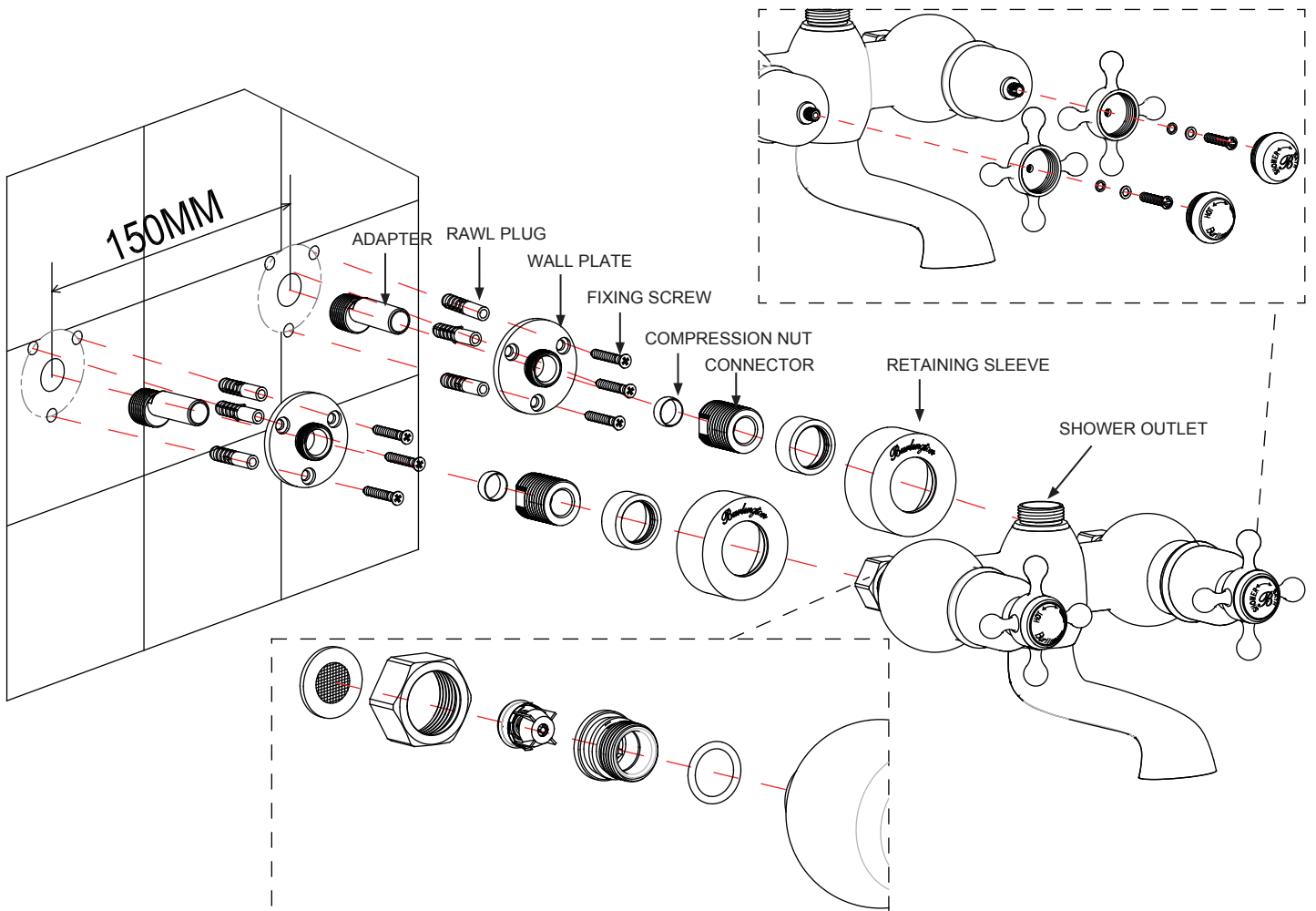

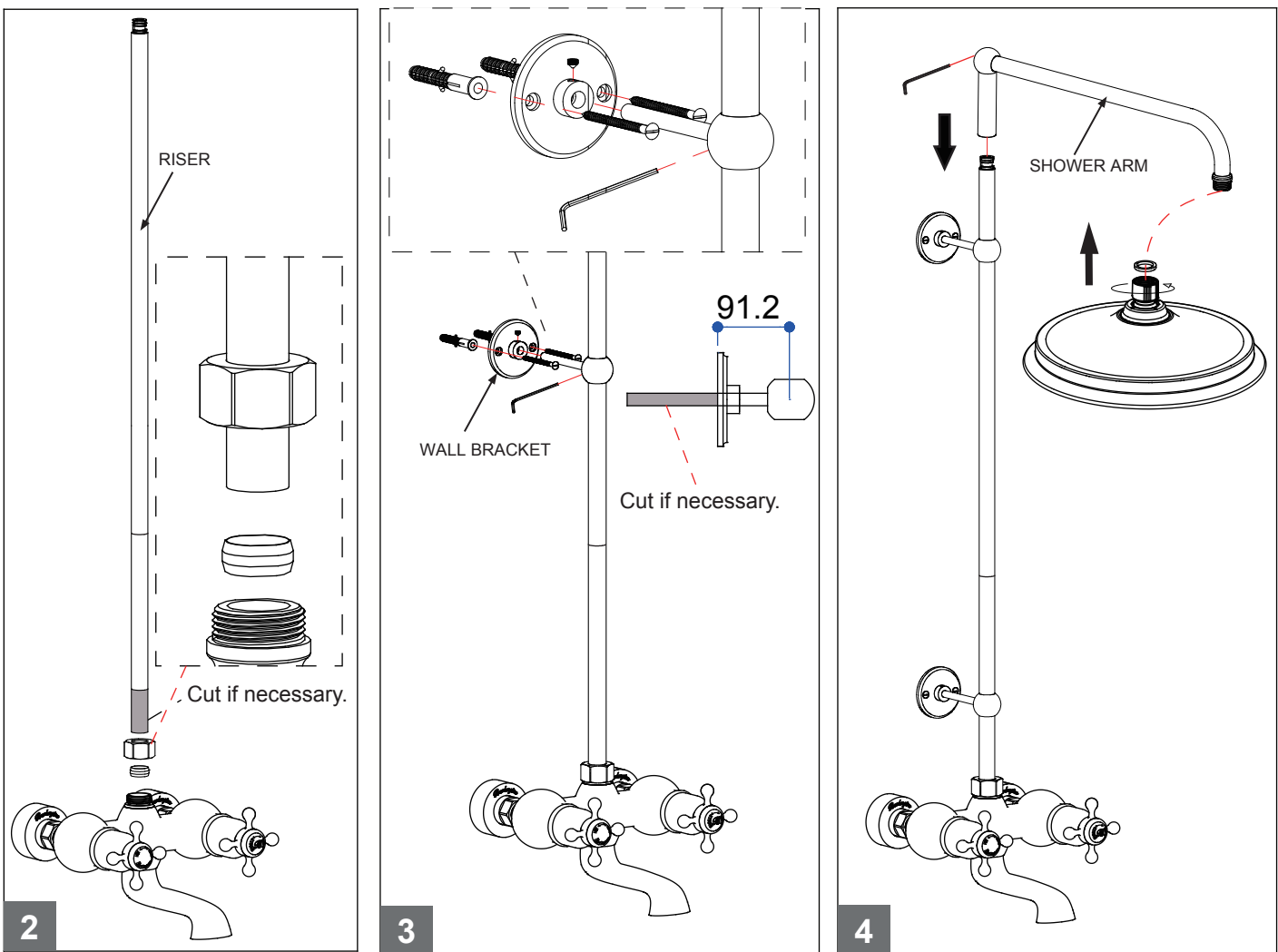

The valve should be installed in accordance with the water bye-laws. For further details refer to the latest copy of Water Bye-laws guide or your local water authority.

Note: Please check for any hidden pipes and cables before drilling holes in the wall.

The fitting of isolation valves is required as close as is practicable to both hot and cold water supply inlets.

1. a: Determine the final installation position and installation height as per the dimension drawing on page 2. On the wall drill at 2 X 22mm diameter holes at 150mm centers. .
- b: Put the wall plate against the wall by centering with the holes drilled above. Make the 6 positions on the wall following the holes in the wall plates. Drill 6x8mm holes on the wall to a depth of 40mm and insert wall plugs.
- c: Smear or wrap a suitable sealing material around the tail of the adapter and then insert the adapter into the holes on the wall, and connect the water supply.
- d: Slide the wall plate through the adapter, fix the wall plate onto the wall by screws supplied.
- e: Assemble the connector with the wall plate and adapter first, then put on the retaining sleeve as shown in the diagram.
- f: Fix the bath shower mixer onto the connector.
2. Connect the riser with the shower valve (see Fig 2).
3. Install the wall bracket onto the wall to hold the riser (see Fig 3).
4. Connect the shower arm with the riser, and put the shower head onto the shower arm (see Fig 4).

Straightener and aerator (alternative options)

The tap comes with a factory-fitted flow straightener for low pressure water systems. If the water flow is high, replace the factory-fitted flow straightener with the high pressure aerator supplied.

Use NEOPERL Key to unscrew the straightener in the Nozzle. Replace with the aerator provided, and screw back in nozzle tightly. (If you misplace the Neoperl key you can use the top of the aerator/straightener as a key)



FLOW STRAIGHTENER

AERATOR

Cleaning

Before use: Unscrew the filter and allow the water to run freely for 5 minutes. Then screw the filter back in place.

Periodically: Using the key provided unscrew the nozzle and remove. Rinse it with cleaning running water until any loose debris is cleared. Then replace the nozzle and tighten with key provided.

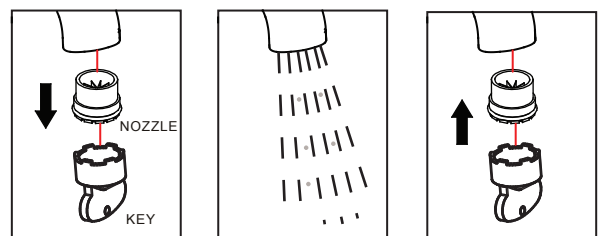

Operation

1. Turn the water flow control handle to increase/decrease the water flow and turn on/off.
2. Turn the temperature control handle to increase/decrease the water temperature.
3. The temperature control knob is pre-set the auto stop at 42°C to avoid scalding.

However, if for any reason the setting is removed it is important to follow "Temperature Setting" procedure to reset.

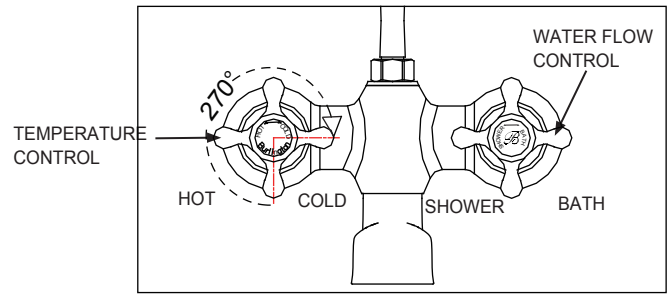

Temperature Setting

The temperature control handles on this product are factory set and should require no adjustment.

However, if for any reason the handles and/or the cartridge is removed it is important the following procedure is followed.

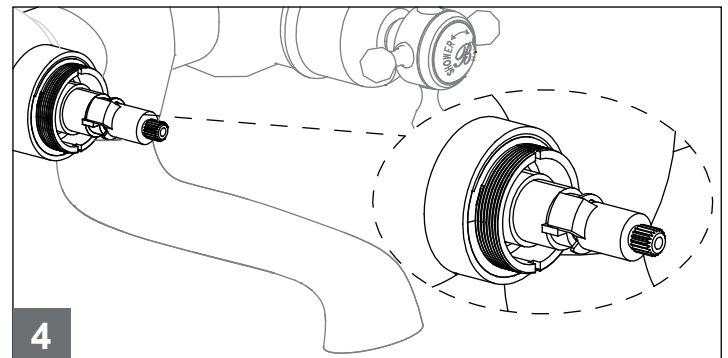
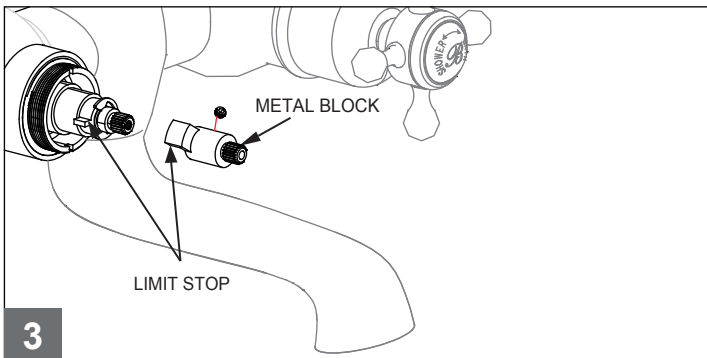
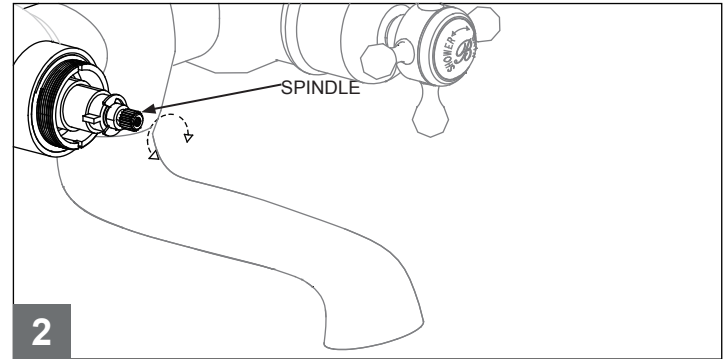
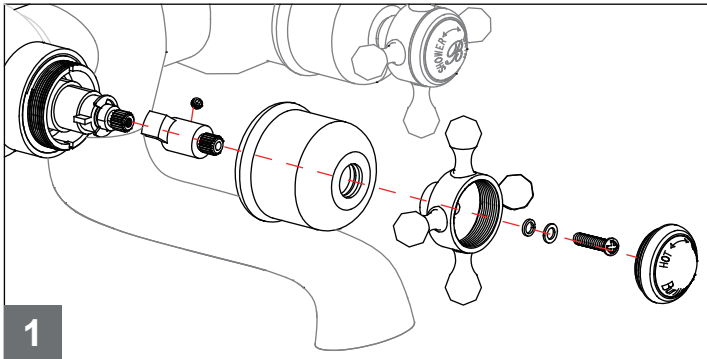

- 1) Remove the temperature control handle, metal block (see Fig 1).
- 2) Rotate the exposed thermostatic spindle (clockwise for cold, and anti-clockwise for hot), until the maximum desired showering temperature is set. The suggested maximum "pre-set" temperature is 42°C (see Fig 2).
- 3) Without any move at the spindle, replace the metal block so that limit stop up to the right hand side of the limit stop on the cartridge (see Fig 3).
- 4) Then refit the temperature control handle.

Maintenance (Thermostatic Cartridge)

* After a long time usage of thermostatic valve, there will be some waste debris from the water pipe on and around the check valve or thermostatic cartridge, which will affect the flow and sensitivity of automatic temperature adjustment. Please take out the thermostatic cartridge, and clean the cartridge strainer.

* To avoid damage, please remove all chrome parts before any maintenance takes place.

Maintenance (Filter & Check valve)

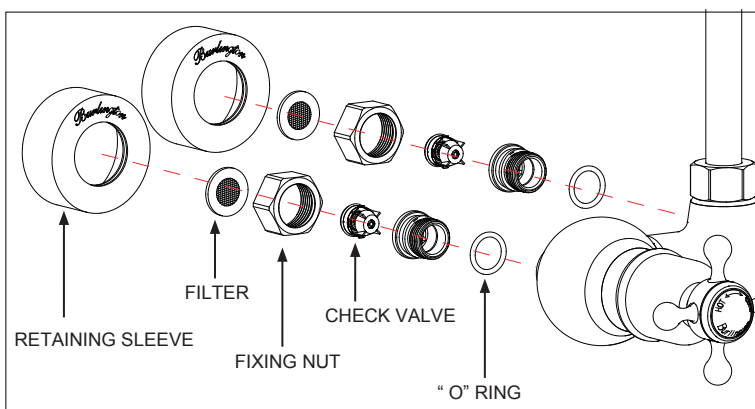

- A) Cutoff the Hot & Cold supply at the isolating valve. Disconnect the hot & cold water supply from the valve.
- B) Take down the valve from the connector at the wall.
- C) Take out the filter, check valve.
- D) Clean the filter and check valve with clean running water, dry and lightly grease the seals. (only use silicone grease)
- E) Put back all of the parts in sequence.

Maintenance (Thermostatic Cartridge)

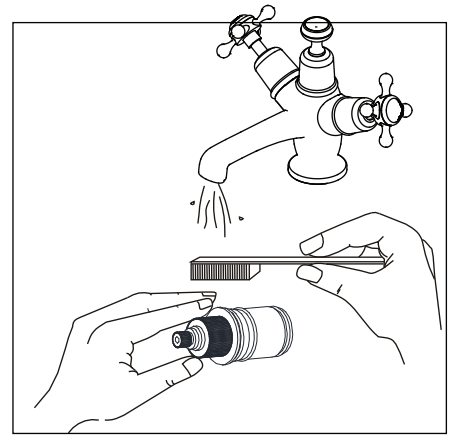
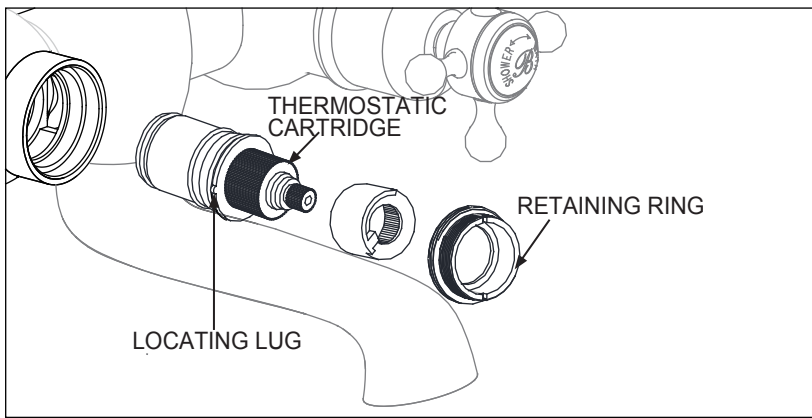

The concealed thermostatic cartridges should give trouble free service, but in the event of failure, servicing is straight forward.

- A) Remove the cartridge retaining ring.
- B) Pull out the thermostatic cartridge.
- C) Wash the thermostatic cartridge with clean running water, dry and lightly grease the seals (only use silicone grease).
- D) Put back the thermostatic cartridge (The locating lug should be sit inside the socket of housing), then tighten the retaining ring.

Commissioning & Annual Test

The installation of thermostatic mixing valves must comply with the requirement of the Water Supply (Water Fittings) Regulations 1999. TMV2 approve valve must be tested once a year, to check if it is out of the original maximum temperature set.

1. Prepare a calibrated thermometer.
2. Adjust to maximum water temperature.
3. Allow water running 5 seconds for stability, measure the mixed water temperature at the outlet.
 - The mixed water temperature at the outlet should never exceed 42°C for showers.
 - The mixed water temperature at the outlet should never exceed 46°C for bath filler.

Note:

46°C is the maximum mixed water temperature from the bath tap. The maximum temperature takes account of the allowable temperature tolerances inherent in thermostatic mixing valves and temperature losses in metal baths. It is not a safe bathing temperature for adults or children. The British Burns Association recommends 37 to 37.5°C as a comfortable bathing temperature for children. In premises covered by the Care Standards Act 2000, the maximum mixed water outlet temperature is 43°C.

IF NOT, then the adjustment of the temperature is necessary following the " Temperature Setting "

4. Close the isolating valve at the Cold water supply. While the flowing is residual, and the water temperature has no any change obviously from the initial maximum temperatue set.
5. Reopen the Cold supply, retest the water temperature. if also having no change obviously. Then the valve is working correctly, no further service work is required.

Trouble Shooting

1. Output water temperature does not correspond with temperature set
Cause: Thermostat has not been adjusted base on the existing home water system
Remedy: Adjust the thermostat, refer to "Temperature Setting" procedure.
Cause: Hot Water temperature too low.
Remedy: Adjuster the water heater, increase hot water temperature to 65°C
2. Crossflow, cold water being forced into hot water pipe, or vice versa, when valve is closed
Cause: check valves dirty or leaking
Remedy: Clean the check valves or exchange if necessary
3. Very low flow or no flow
Cause: Supply pressure inadequate
Remedy: Check hot and cold feeds. If a pump has been installed, please check to see if the pump is working.
(the valve will shut down if either the cold or hot water supply fails)
4. Water will not run hot enough when first installed
Cause: Wrong maximum temperature setting
Remedy: Adjust the maximum temperature, refer to "Temperature Setting" procedure.

Cleaning

We do NOT recommend you use any household cleaners to clean the product. Because these cleaners change substance or formula too frequently. So product should be always cleaned only with soapy water and rinsing with clean water and drying with soft cloth.