



FANTINI

RUBINETTI

MILANO

Miscelatore monocomando lavabo a parete Art. D113A+E613B / Wall-mounted single-lever washbasin mixer Art. D113A+E613B / Mitigeur lavabo mural Art. D113A+E613B

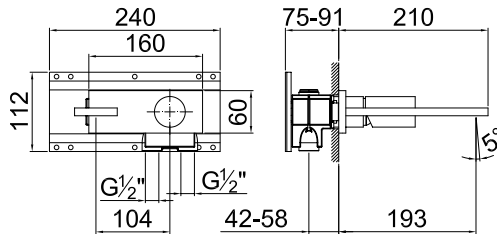

| N° | Codice / Code | Descrizione / Description / Désignation |
|-----|---------------|---|
| 1 | 90 00 8688 | Cannotto porta cartuccia per Art. E610B-E613B Sleeve for cartridge for Art. E610B-E613B Manchon pour cartouche pour Art. E610B-E613B |
| 2 | 90 00 3770 | Cartuccia dischi ceramici suite D.35 cartridge suite Cartouche D.35 suite |
| 3 | 90 00 9039 | Ghiera di bloccaggio cartuccia oceano Locking ring for cartridge Bague d'arrêt pour cartouche |
| 4 | 90 00 9263 | Cappuccio sottomaniglia Café Cup under Café handle Rosace sous manette Café |
| 5 | 90 00 8687 | Perno fissaggio piastra per Art. E510B-E513B-E610B-E613B Fixing pivot for plate for Art. E510B-E513B-E610B-E613B Pivot de fixation pour plaque pour Art. E510B-E513B-E610B-E613B |
| 6 | 90 00 9638 | Perno con dado per fissaggio piastra 3010 - 3013 Milano Fixing screw nut for plate Art. 3010 - 3013 Pivot avec ecrou de fixation pour plaque Art. 3010 - 3013 |
| 7 | 90 00 9643 | Bocca completa e piastra per Art. 3013 Milano Complete spout and plate for Art. 3013 Bec complet et plaque pour Art. 3013 |
| 7A | 90 00 9639 | Perno c/o'ring e limitatore per Art. 3010 - 3013 Pivot with o'ring and flow control for Art. 3010 - 3013 Pivot avec o'ring et limiteur de debit pour Art. 3010 - 3013 |
| 7A1 | 90 00 9597 | Limitatore 9 l/m per Art. 5010 - 5013 9 l/m flow control for Art. 5010 - 5013 Limiteur de debit 9 l/m pour Art. 5010 - 5013 |
| 7B | 90 00 9640 | Piastra sola per Art. 3010 - 3013 Plate for Art. 3010 - 3013 Plaque pour Art. 3010 - 3013 |
| 7B1 | 90 00 9778 | O'ring per piastra per Art. 3010B-3013B Milano O'ring for plate for Art. 3010B-3013B Milano O'ring pour plaque pour Art. 3010B-3013B Milano |
| 7C | 90 00 9614 | Bocca sola per Art. 5013 Spout for Art. 5013 Bec pour Art. 5013 |
| 7C1 | 90 00 9588 | Aeratore Slim c/chiave per Art. 5004-5006-5008-5204-5010-5013 Slim aerator with key for Art. 5004-5006-5008-5204-5010-5013 Aerator Slim avec cle pour Art. 5004-5006-5008-5204-5010-5013 |
| 8 | 90 00 9642 | Maniglia completa per Art. 3010 - 3013 Milano Maniglia completa per Art. 3010 - 3013 Complete handle for Art. 3010 - 3013 |
| 8A | 90 00 9041 | Grano bloccaggio maniglia Locking screw for handle Vis d'arrêt pour manette |
| 8B | 90 00 9428 | Placchetta Screw cover for handle Cabochon pour manette |

MILANO

Miscelatore monocomando lavabo a parete Art. D113A+E613B / Wall-mounted single-lever washbasin mixer Art. D113A+E613B / Mitigeur lavabo mural Art. D113A+E613B

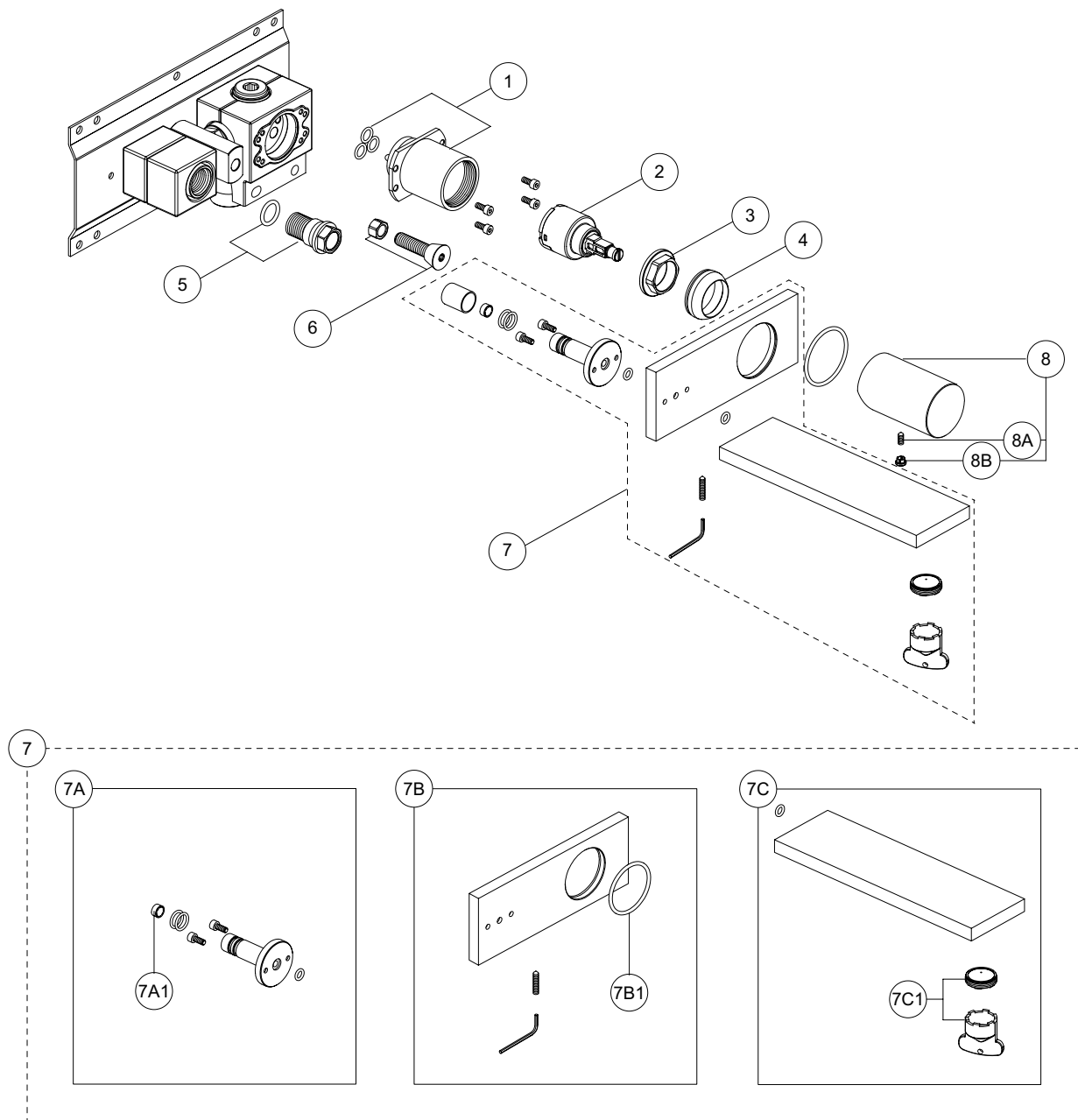

USCITA PRIMARIA

| Pressione - Pressure Pression | Portata - Flow rate Debit d'eau |
|----------------------------------|------------------------------------|
| 0,5 bar | 4 l/min |
| 1 bar | 6 l/min |
| 2 bar | 8 l/min |
| 3 bar | 9 l/min |
| 4 bar | 9 l/min |
| 5 bar | 9 l/min |

Aeratore Slim senza classe di portata.
Nr. 1 limitatore 9 l/m