

Floor stand with disinfectant dispenser, touchless

d line

PRODUCT DATA SHEET

ITEM NUMBER 14.7046.02.040
SURFACE Satin Stainless Steel

PRODUCT
Floor stand with disinfectant dispenser, touchless

PICTURE



TENDER TEXT

Floor stand with disinfectant dispenser, touchless. Material: stainless steel AISI 316 satin finish. Capacity 800ml. Battery operated. Concealed fixing. Net weight: 10,2 kg.
W:280 mm x H:1375 mm x D:280 mm

PRODUCT SPECIFICATION

Dimensions: W:280 mm x H:1375 mm x D:280 mm

Capacity: 800 ml

Material: stainless steel AISI 316

Satin grain 320, crafted by hand

Dispenses disinfectant (alcohol should not exceed 85%)^①

Dispensing volume (viscosity) ~1 ml, ~800 doses (1~3000 cP).

Room temperature 5~40°C.

Battery alkaline (1,5V) AA size, qty 4(included) or AC adaptor.

Battery life estimated ~40,000 cycles (depends on alkaline battery type).

Mechanism life estimated ~500,000 cycles

Operation mode automatic from sensor trigger

Locking mechanism with key

At least 200 mm space below is required

Warranty for mechanism - 2 years

Warranty for stainless steel (non movable) parts - 20 years

DRAWING

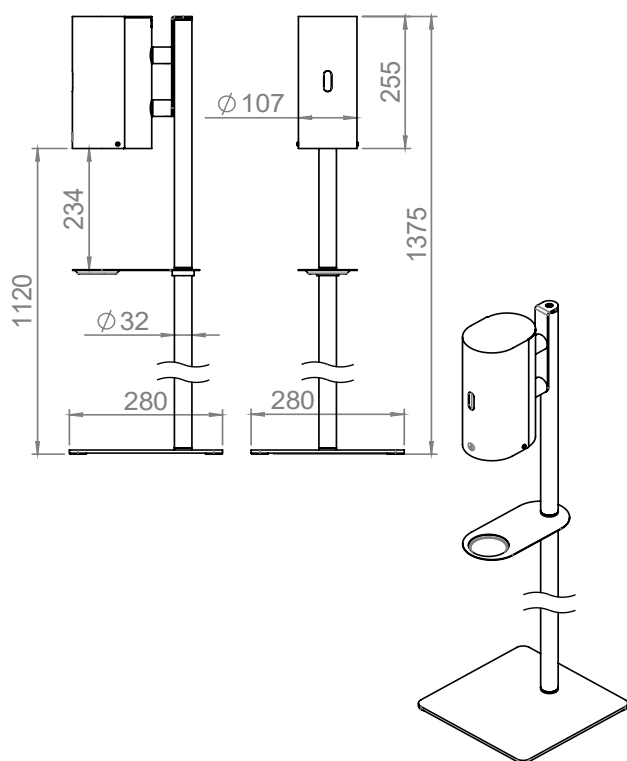

SPARE PARTS / ACCESSORIES:

14.7046.02.010 - Disinfection dispenser, touchless

14.7046.02.002 - floor stand for touchless dispenser

MOUNTING:

Refer to floor stand mounting instruction

PACKING:

1 set. per package

CERTIFICATES & AWARDS



PRODUCT CARE

d line products are produced in the highest quality stainless steel, marine grade, AISI 316. To sustain the unique d line finish appearance please follow the below instructions:

- Wash down the surfaces using soapy water or mild detergent
- Always thoroughly rinse off with clean water
- To complete the cleaning procedure dry/polish the surfaces with a soft dry cloth

Please do not use scouring powder, steel wool, chloride based detergents or other aggressive cleaning products as these may damage the surface.

If spots or corrosion appear on the surface it is not due to the stainless steel quality, but to impurities in the environment, aggressive conditions or improper or insufficient cleaning.

Link to our maintenance guide: <https://dline.com/maintenance/>