

Composizione a 2 vie
2 ways shower set

Art. **AY650IN** + (**AY650RSA** o/or **AY650RLU**)

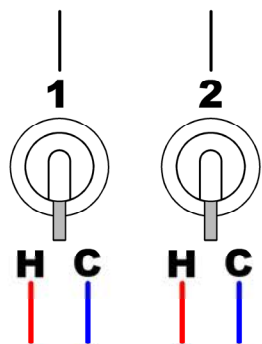

Corpo ad incasso per Art.
AY650PSA, Art. AY650PLU, Art.
AY650RSA e Art. AY650RLU.
*Concealed valve for Art. AY650PSA,
Art. AY650PLU, Art. AY650RSA and
Art. AY650RLU.*

Composizione doccia 2 miscelatori
Shower set 2 mixers

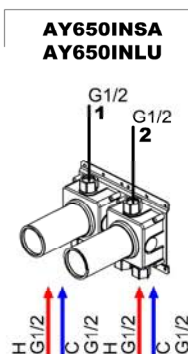

Composizione a 2 vie
2 ways shower set

Art. **AY650IN** + (**AY650PSA** o/or **AY650PLU**)

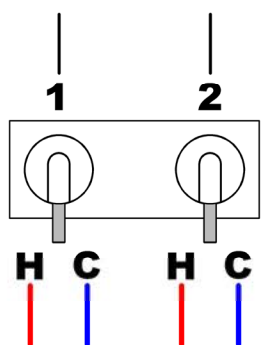

Corpo ad incasso per Art.
AY650PSA, Art. AY650PLU, Art.
AY650RSA e Art. AY650RLU.
*Concealed valve for Art. AY650PSA,
Art. AY650PLU, Art. AY650RSA and
Art. AY650RLU.*

Composizione doccia 2 miscelatori
Shower set 2 mixers

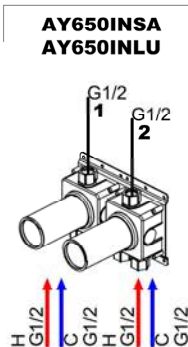

+

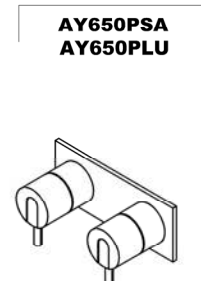

Composizione a 3 vie
3 ways shower set

Art. AY651IN + (AY651RSA o/or AY651RLU)

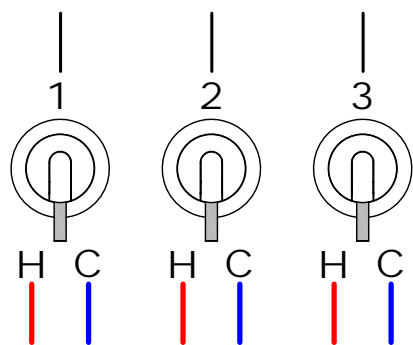

Corpo ad incasso per Art.
AY651PSA, Art. AY651PLU, Art.
AY651RSA e Art. AY651RLU
*Concealed valve for Art.
AY651PSA, Art. AY651PLU, Art.
AY651RSA and Art. AY651RLU.*

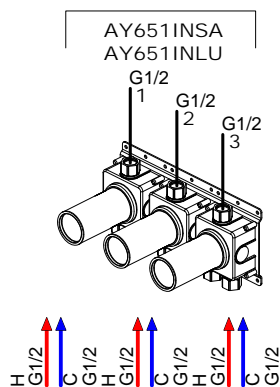

Composizione doccia 3 miscelatori
Shower set 3 mixers

+

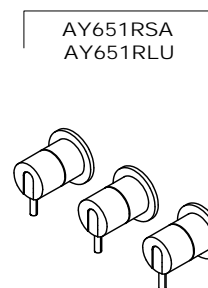

Composizione a 3 vie
3 ways shower set

AY651IN + (AY651PSA o/or AY651PLU)

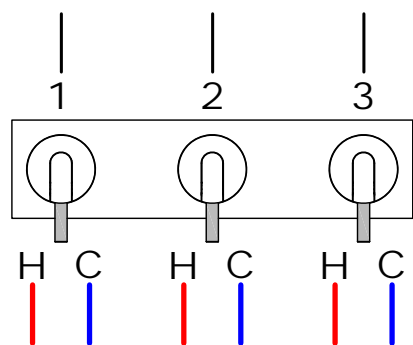

Corpo ad incasso per Art.
AY651PSA, Art. AY651PLU, Art.
AY651RSA e Art. AY651RLU
*Concealed valve for Art.
AY651PSA, Art. AY651PLU, Art.
AY651RSA and Art. AY651RLU.*

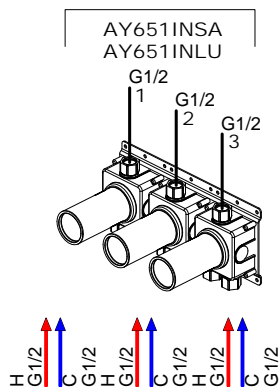

+

Composizione doccia 3 miscelatori
Shower set 3 mixers

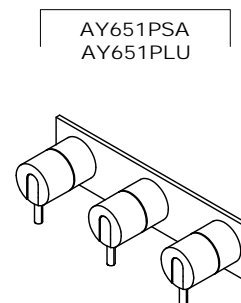

Composizione a 2 vie
2 ways shower set

Art. AY652IN + (AY652RSA o/or AY652RLU)

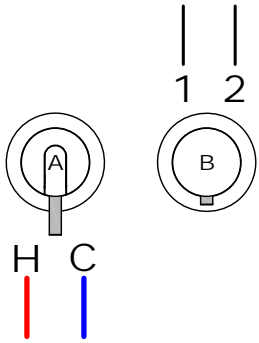

B Rotazione deviatore
Art. AY652RSA e AY652RLU

Rotation diverter
Art. AY652RSA and AY652RLU

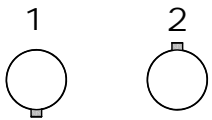

Corpo ad incasso per Art.
AY652PSA, Art. AY652PLU, Art.
AY652RSA e Art. AY652RLU.
Concealed valve for Art.
AY652PSA, Art. AY652PLU, Art.
AY652RSA and Art. AY652RLU.

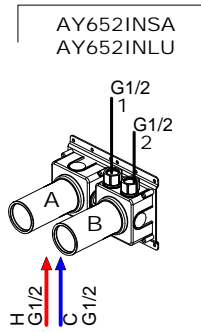

+

Composizione doccia 1 miscelatore
(A) e 1 deviatore 2 vie (A),
Shower set 1 mixer (A), 1 two way
diverter (B).

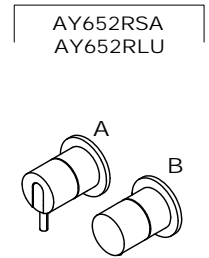

Composizione a 2 vie
2 ways shower set

AY652IN + (AY652PSA or AY652PLU)

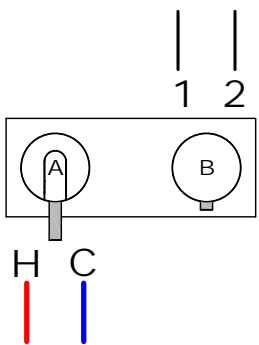

B Rotazione deviatore
Art. AY652PSA e AY652PLU

Rotation diverter
Art. AY652PSA and AY652PLU

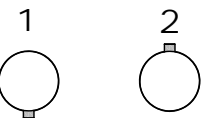

Corpo ad incasso per Art.
AY652PSA, Art. AY652PLU, Art.
AY652RSA e Art. AY652RLU.
Concealed valve for Art.
AY652PSA, Art. AY652PLU, Art.
AY652RSA and Art. AY652RLU.

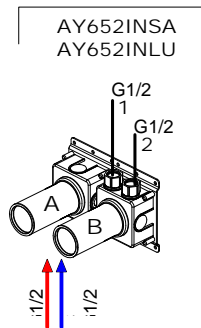

+

Composizione doccia 1 miscelatore
(A) e 1 deviatore 2 vie (A),
Shower set 1 mixer (A), 1 two way
diverter (B).

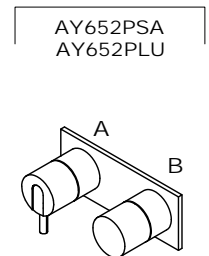

Composizione a 3 vie
3 ways shower set

AY653IN + (AY653RSA o/or AY653RLU)

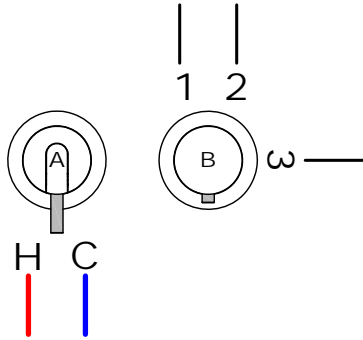

B Rotazione deviatore
Art. AY653RSA e AY653PLU

Rotation diverter
Art. AY653RSA and AY653PLU

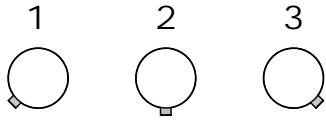

Corpo ad incasso per Art.
AY653PSA, Art. AY653PLU, Art.
AY653RSA e Art. AY653RLU.
Concealed valve for Art.
AY653PSA, Art. AY653PLU, Art.
AY653RSA and Art. AY653RLU.

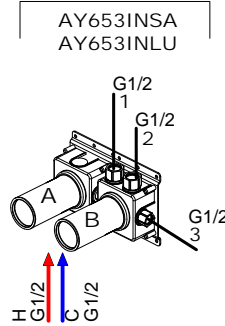

+

Composizione doccia 1 miscelatore
(A) e 1 deviatore 3 vie (B), escluso
di corpo ad incasso.
Shower set 1 mixer (A), 1 three
way diverter (B), concealed valve
not included.

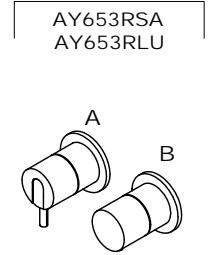

Composizione a 3 vie
3 ways shower set

AY653IN + (AY653PSA o/or AY653PLU)

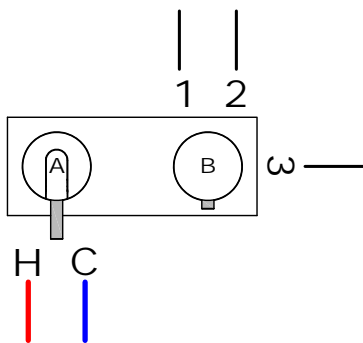

B Rotazione deviatore
Art. AY653PSA e AY653PLU

Rotation diverter
Art. AY653PSA and AY653PLU

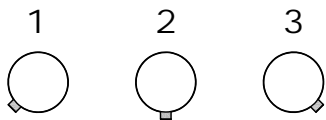

Corpo ad incasso per Art.
AY653PSA, Art. AY653PLU, Art.
AY653RSA e Art. AY653RLU.
Concealed valve for Art.
AY653PSA, Art. AY653PLU, Art.
AY653RSA and Art. AY653RLU.

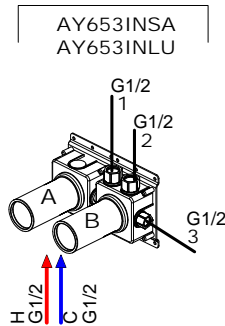

+

Composizione doccia 1 miscelatore
(A) e 1 deviatore 3 vie (B), escluso
di corpo ad incasso.
Shower set 1 mixer (A), 1 three
way diverter (B), concealed valve
not included.

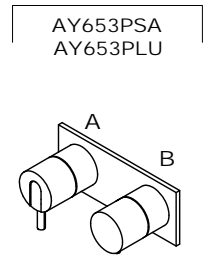

Composizione a 2 vie
2 ways shower set

Art. AY654IN + (AY654RSA o/or AY654RLU)

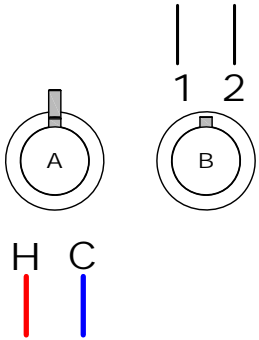

B Rotazione deviatore
Art. AY654RSA e AY654RLU

Rotation diverter
Art. AY654RSA and AY654RLU

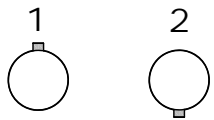

Corpo ad incasso per Art.
AY654PSA, Art. AY654PLU, Art.
AY654RSA e Art. AY654RLU.
Concealed valve for Art.
AY654PSA, Art. AY654PLU, Art.
AY654RSA and Art. AY654RLU.

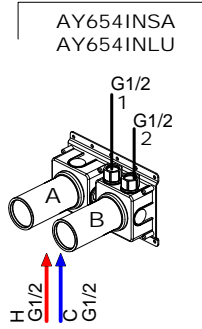

+

Composizione doccia 1 termostatico
coassiale con apertura e chiusura
acqua (A) e 1 deviatore 2 vie (B)
Shower set with coaxial
thermostatic command handle (A),
two way diverter (B)

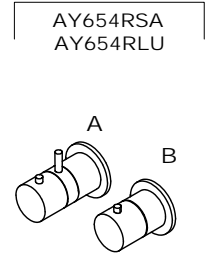

Composizione a 2 vie
2 ways shower set

AY654IN + (AY654PSA o/or AY654PLU)

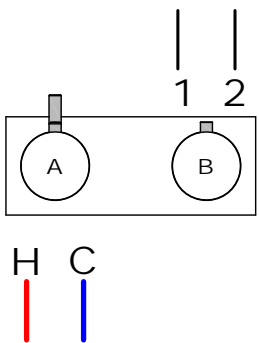

B Rotazione deviatore
Art. AY654PSA e AY654PLU

Rotation diverter
Art. AY654PSA and AY654PLU

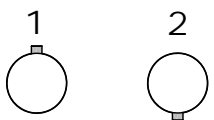

Corpo ad incasso per Art.
AY654PSA, Art. AY654PLU, Art.
AY654RSA e Art. AY654RLU.
Concealed valve for Art.
AY654PSA, Art. AY654PLU, Art.
AY654RSA and Art. AY654RLU.

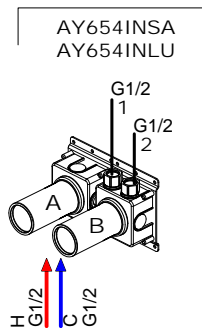

+

Composizione doccia 1 termostatico
coassiale con apertura e chiusura
acqua (A) e 1 deviatore 2 vie (B)
Shower set with coaxial
thermostatic command handle (A),
two way diverter (B)

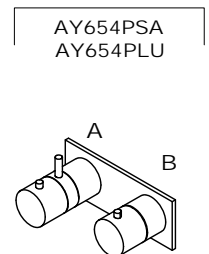

Composizione a 3 vie
3 ways shower set

Art. AY655IN + (AY655RSA o/or AY655RLU)

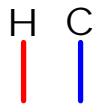
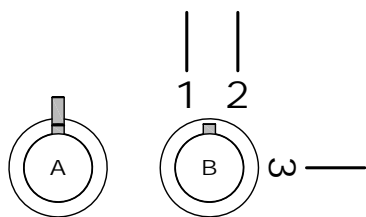

B Rotazione deviatore
Art. AY655RSA e AY655RLU

Rotation diverter
Art. AY655RSA and AY655RLU

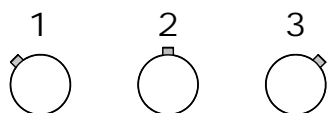

Corpo ad incasso per Art.
AY655PSA, Art. AY655PLU, Art.
AY655RSA e Art. AY655RLU.
Concealed valve for Art.
AY655PSA, Art. AY655PLU, Art.
AY655RSA and Art. AY655RLU.

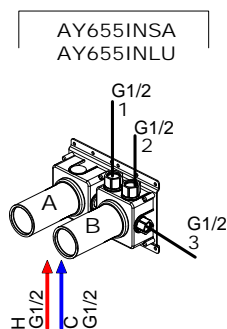

+

Composizione doccia 1 termostatico
coassiale con apertura e chiusura
acqua (A) e 1 deviatore 3 vie (B)
Shower set with coaxial
thermostatic command handle (A),
three way diverter (B)

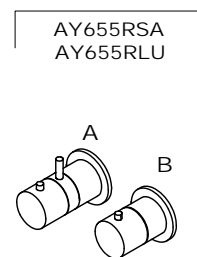

Composizione a 3 vie
3 ways shower set

AY655IN + (AY655PSA o/or AY655PLU)

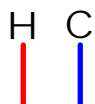
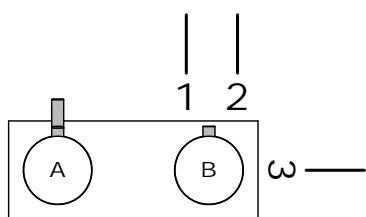

B Rotazione deviatore
Art. AY655PSA e AY655PLU

Rotation diverter
Art. AY655PSA and AY655PLU

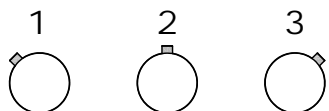

Corpo ad incasso per Art.
AY655PSA, Art. AY655PLU, Art.
AY655RSA e Art. AY655RLU.
Concealed valve for Art.
AY655PSA, Art. AY655PLU, Art.
AY655RSA and Art. AY655RLU.

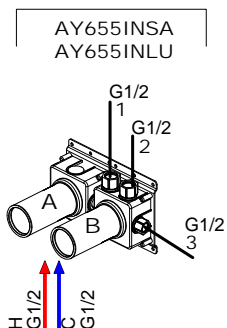

+

Composizione doccia 1 termostatico
coassiale con apertura e chiusura
acqua (A) e 1 deviatore 3 vie (B)
Shower set with coaxial
thermostatic command handle (A),
three way diverter (B)

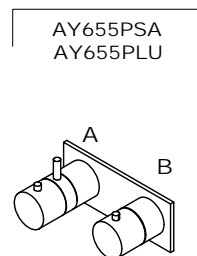

Composizione a 2 vie 2 ways shower set

Art. N°2 (SP601INSA o/or SP601INLU) + N°2 (AY601SA o/or AY601LU)

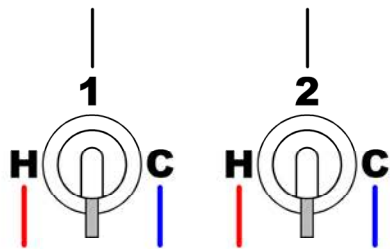

Corpo ad incasso per Art. AY601SA
e Art. AY601LU
Concealed valve for Art. AY601SA
and Art. AY601LU.

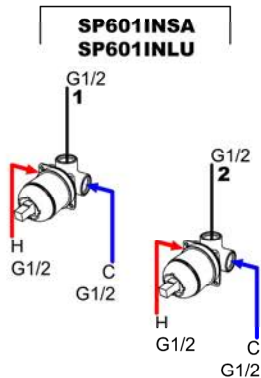

Composizione doccia 2 miscelatori
Shower set 2 mixers

+



Composizione a 3 vie 3 ways shower set

Art. N°3 (SP601INSA o/or SP601INLU) + N°3 (AY601SA o/or AY601LU)

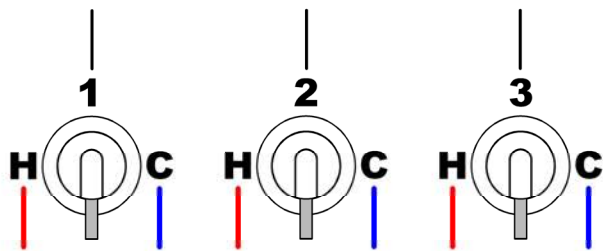

Corpo ad incasso per Art. AY601SA
e Art. AY601LU
Concealed valve for Art. AY601SA
and Art. AY601LU.

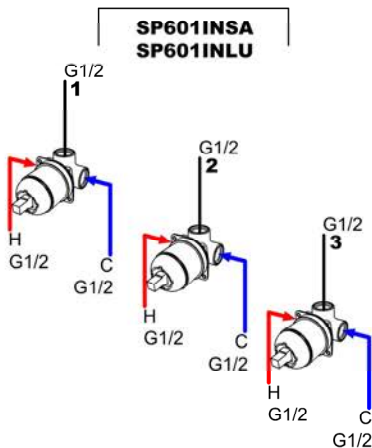

Composizione doccia 3 miscelatori
Shower set 3 mixers

+

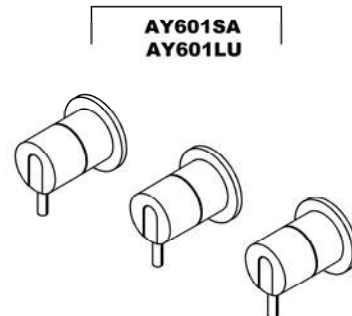

Composizione a 2 vie 2 ways shower set

Art. (SP604INSA o/or SP604INLU) + (AY604SA o/or AY604LU) + (SP602INSA o/or SP602INLU) + (AY602SA o/or AY602LU)

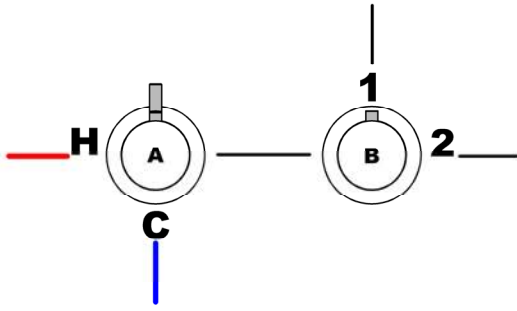

B Rotazione deviatore
Art. AY602SA e AY602LU
Rotation diverter
Art. AY602SA and AY602LU

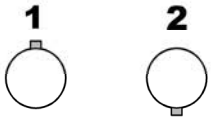

Miscelatore termostatico
Thermostatic mixer

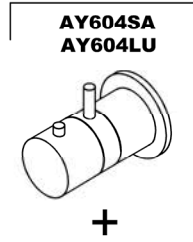

+



Corpo ad incasso per Art. AY604SA
e Art. AY604LU
Concealed valve for Art. AY604SA
and Art. AY604LU

Deviatore incasso a due vie
Encased two way diverter

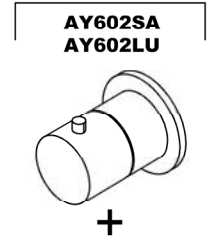

+

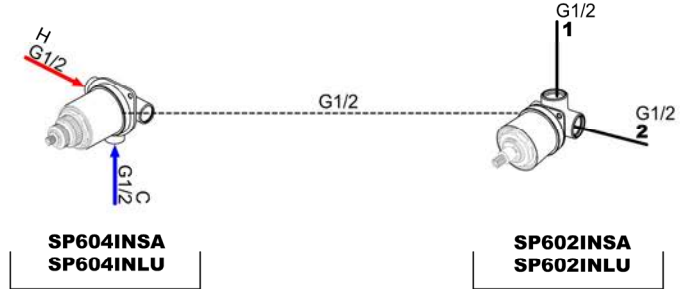

Corpo ad incasso per Art. AY602SA
e Art. AY602LU
Concealed valve for Art. AY602SA
and Art. AY602LU

Composizione a 3 vie 3 ways shower set

Art. (SP604INSA o/or SP604INLU) + (AY604SA o/or AY604LU) + (SP603INSA o/or SP603INLU) + (AY603SA o/or AY603LU)

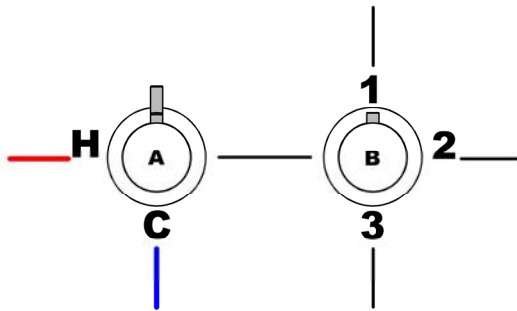

B Rotazione deviatore
Art. AY603SA e AY603LU
Rotation diverter
Art. AY603SA and AY603LU

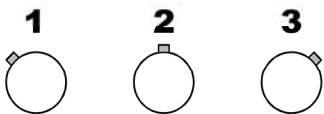

Miscelatore termostatico
Thermostatic mixer



+

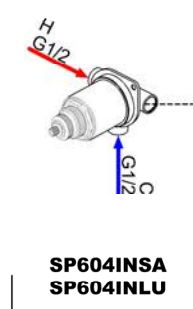

Corpo ad incasso per Art. AY604SA
e Art. AY604LU
Concealed valve for Art. AY604SA
and Art. AY604LU

Deviatore incasso a tre vie
Encased three way diverter



+

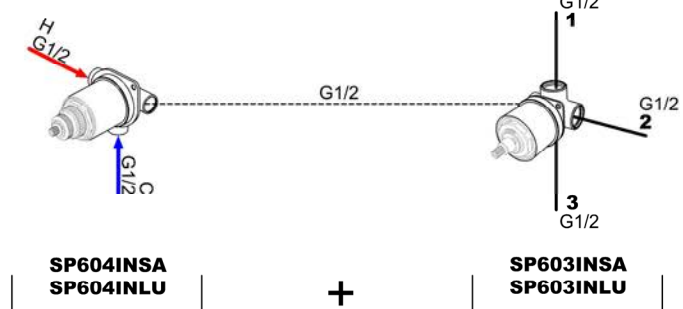

Corpo ad incasso per Art. AY603SA
e Art. AY603LU
Concealed valve for Art. AY603SA
and Art. AY603LU