

Composizione a 2 vie
2 ways shower set

Art. ND601 + ND602

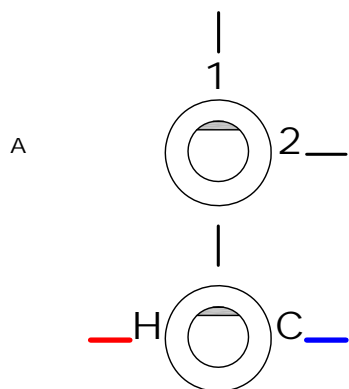

A Rotazione deviatore
Art. ND602

Rotation diverter
Art. ND 602

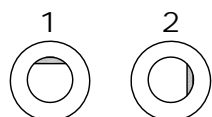

Corpo ad incasso per Art. ND602
Concealed valve for Art. ND602

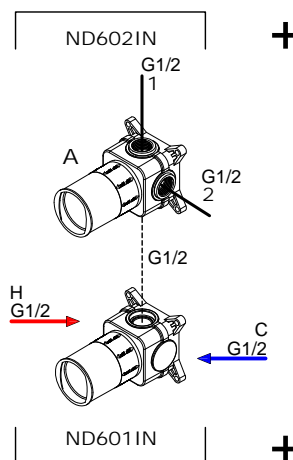

Deviatore a due vie
Two way diverter

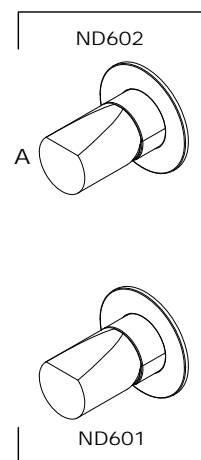

Corpo ad incasso per Art. ND601
Concealed valve for Art. ND601

Miscelatore
Mixer

Composizione a 3 vie
3 ways shower set

Art. ND601 + ND603

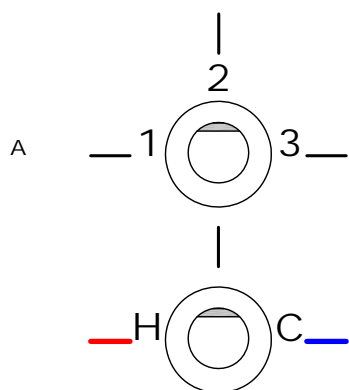

A Rotazione deviatore
Art. ND603

Rotation diverter
Art. ND 603

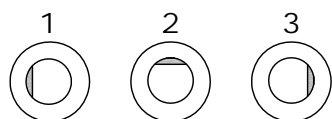

Corpo ad incasso per Art. ND603
Concealed valve for Art. ND603

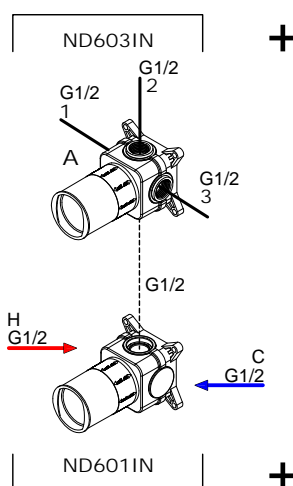

Deviatore a tre vie
Three way diverter

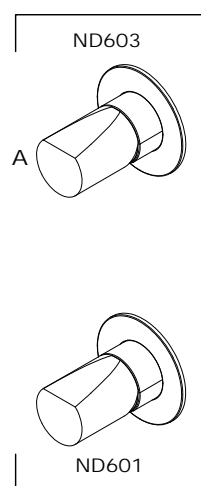

Corpo ad incasso per Art. ND601
Concealed valve for Art. ND601

Miscelatore
Mixer

Composizione a 1 via
1 ways shower set

Art. ND604 + ND605

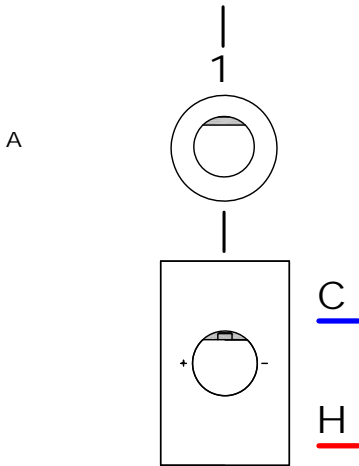

A Rotazione rubinetto da arresto Art. ND605
Rotation stop valve Art. ND 605

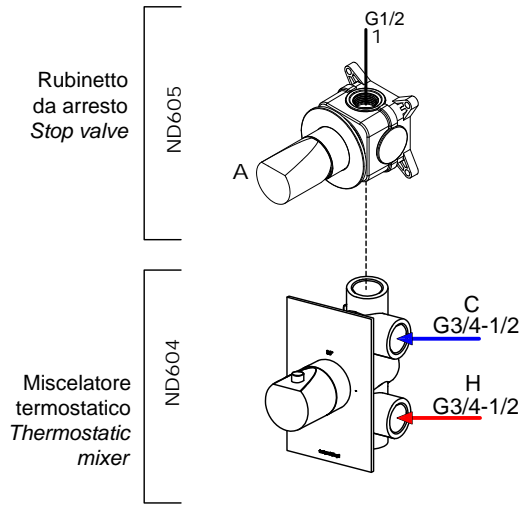
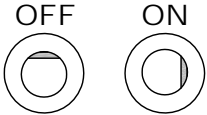

Composizione a 2 vie
2 ways shower set

Art. ND604 + ND605 + ND602IN + ND602

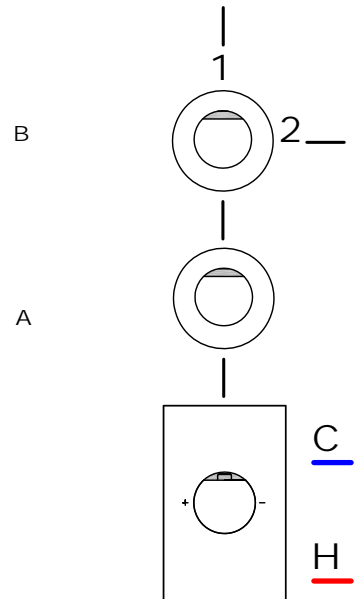

A Rotazione rubinetto da arresto Art. ND605

Rotation stop valve Art. ND 605



B Rotazione deviatore Art. ND602

Rotation diverter Art. ND 602

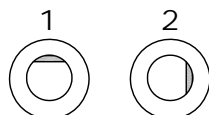

Corpo ad incasso per Art. ND602
Concealed valve for Art. ND602

Deviatore a due vie
Two way diverter

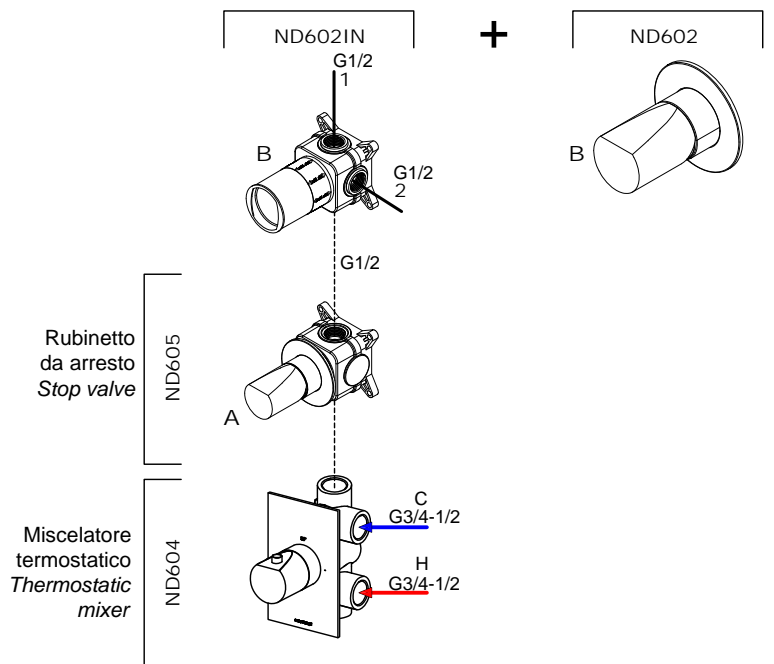

Composizione a 3 vie
3 ways shower set

Art. ND604 + ND605 + ND603IN + ND603

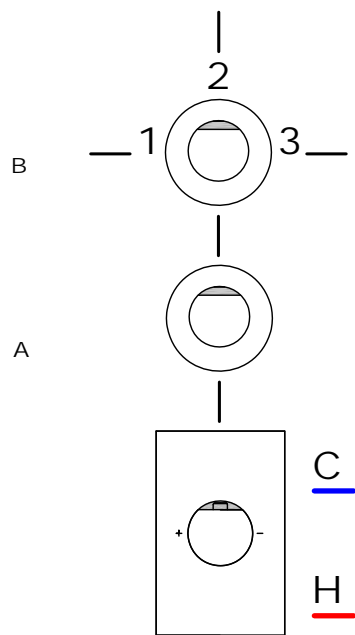

A Rotazione rubinetto da arresto
Art. ND605

Rotation stop valve
Art. ND 605

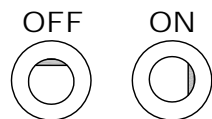

B Rotazione deviatore
Art. ND603

Rotation diverter
Art. ND 603

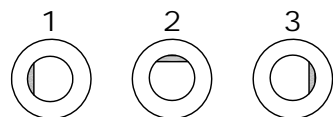

Corpo ad incasso per Art. ND603
Concealed valve for Art. ND603

Deviatore a tre vie
Three way diverter

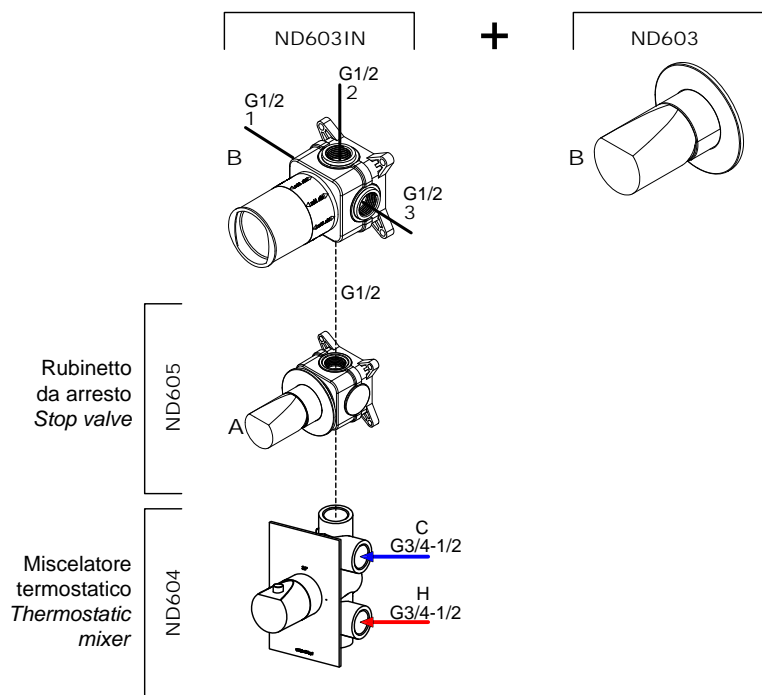

Composizione a 4 vie
4 ways shower set

Art. ND604 + N°2 ND605 + ND603IN + ND603

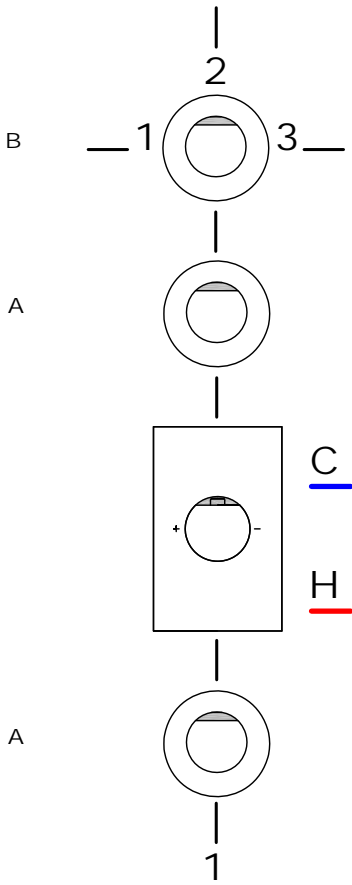

A Rotazione rubinetto da arresto
Art. ND605

Rotation stop valve
Art. ND 605

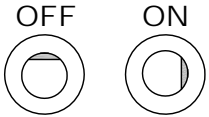

B Rotazione deviatore
Art. ND603

Rotation diverter
Art. ND 603

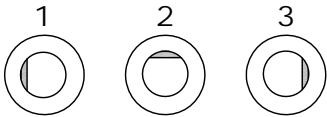

Corpo ad incasso per Art. ND603
Concealed valve for Art. ND603

Deviatore a tre vie
Three way diverter

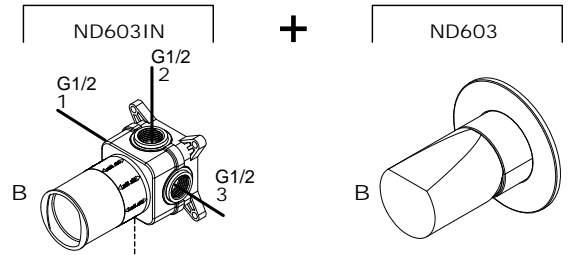

Rubinetto da arresto
Stop valve

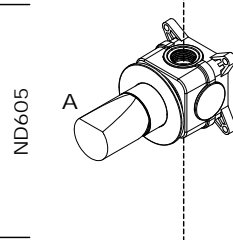

Miscelatore termostatico
Thermostatic mixer

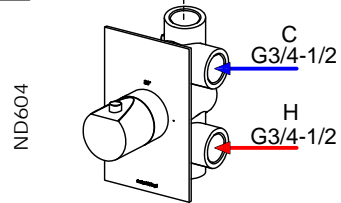

Rubinetto da arresto
Stop valve

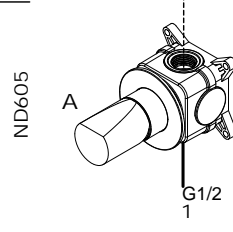

Composizione a 4 vie
4 ways shower set

Art. ND604 + N°2 ND605 + N°2 ND602IN + N°2 ND602

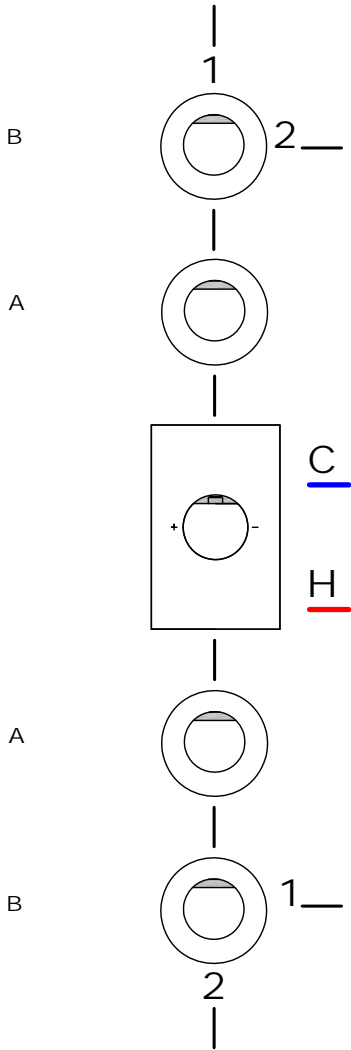

A Rotazione rubinetto da arresto
Art. ND605

Rotation stop valve
Art. ND 605

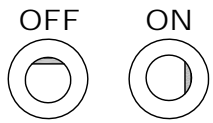

B Rotazione deviatore
Art. ND602

Rotation diverter
Art. ND 602

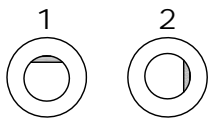

Corpo ad incasso per Art. ND602
Concealed valve for Art. ND602

Deviatore a due vie
Two way diverter

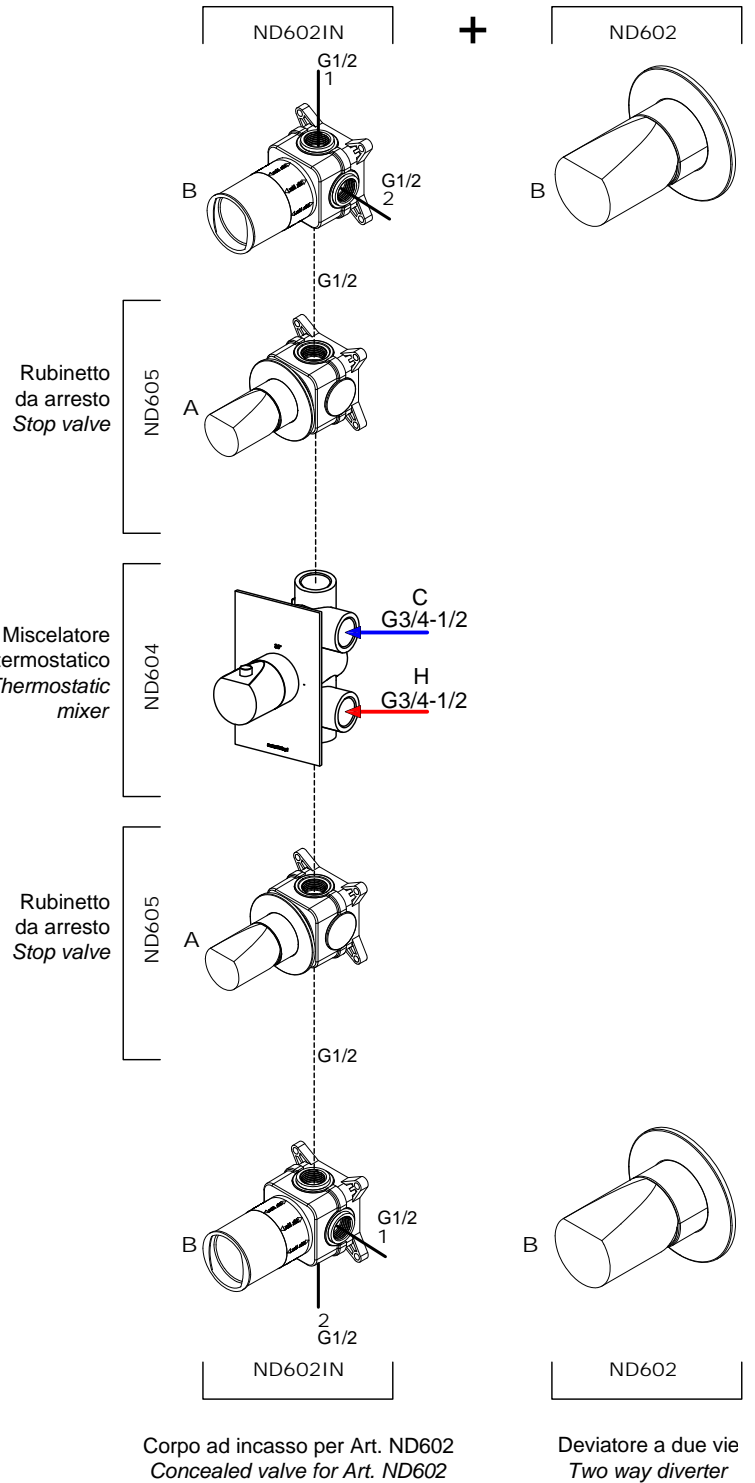

Rubinetto da arresto
Stop valve

ND605

Miscelatore termostatico
Thermostatic mixer

ND604

Rubinetto da arresto
Stop valve

ND605

Corpo ad incasso per Art. ND602
Concealed valve for Art. ND602

Deviatore a due vie
Two way diverter

Composizione a 5 vie
5 ways shower set

Art. ND604 + N°2 ND605 + ND603IN + ND603 + ND602IN + ND602

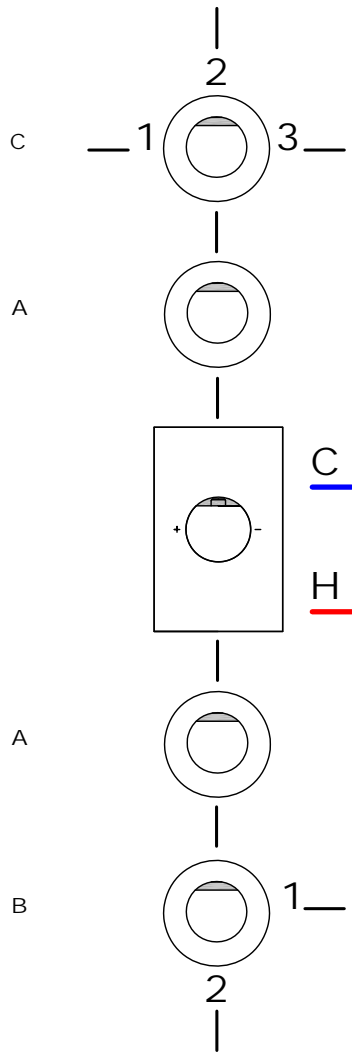

A Rotazione rubinetto da arresto
Art. ND605

Rotation stop valve
Art. ND 605

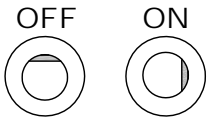

B Rotazione deviatore
Art. ND602

Rotation diverter
Art. ND 602

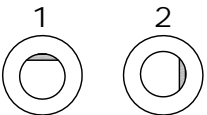

C Rotazione deviatore
Art. ND603

Rotation diverter
Art. ND 603

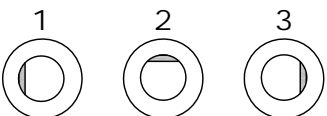

Corpo ad incasso per Art. ND603
Concealed valve for Art. ND603

Deviatore a tre vie
Three way diverter

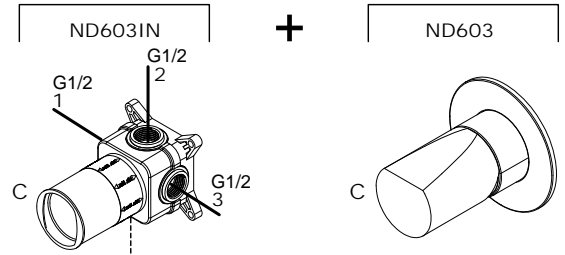

Rubinetto da arresto
Stop valve

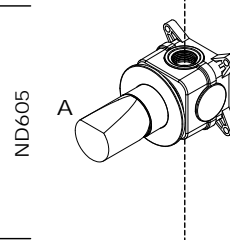

Miscelatore termostatico
Thermostatic mixer

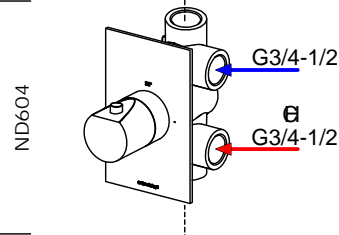

Rubinetto da arresto
Stop valve

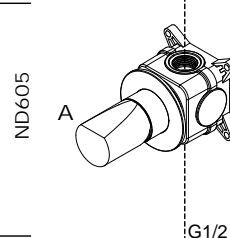

G1/2

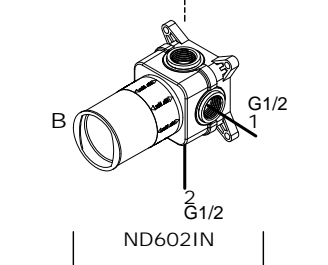

Corpo ad incasso per Art. ND602
Concealed valve for Art. ND602

Deviatore a due vie
Two way diverter

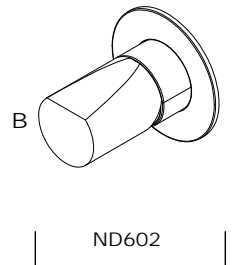

Composizione a 6 vie
6 ways shower set

Art. ND604 + N°2 ND605 + N°2 ND603IN + N°2 ND603

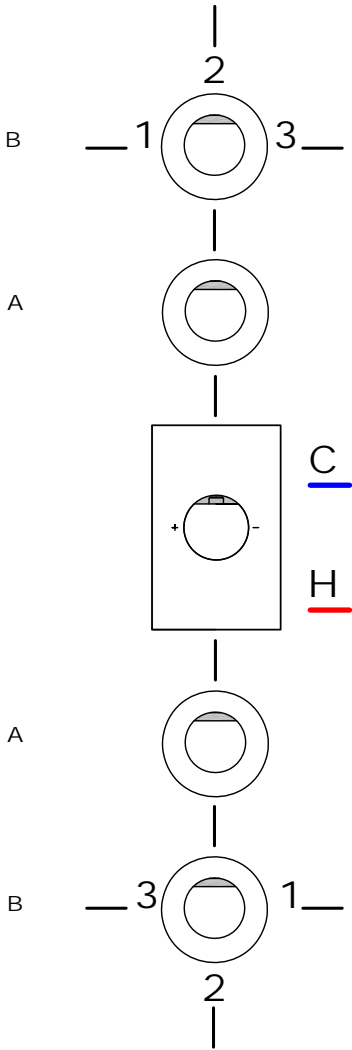

A Rotazione rubinetto da arresto
Art. ND605

Rotation stop valve
Art. ND 605

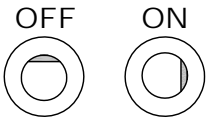

B Rotazione deviatore
Art. ND603

Rotation diverter
Art. ND 603

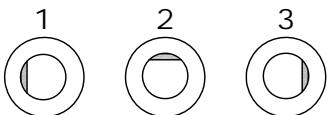

Corpo ad incasso per Art. ND603
Concealed valve for Art. ND603

Deviatore a tre vie
Three way diverter

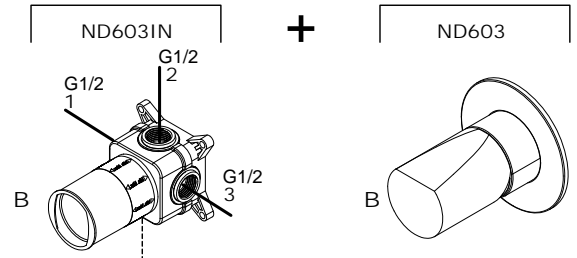

Rubinetto da arresto
Stop valve

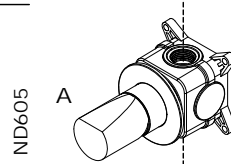

Miscelatore termostatico
Thermostatic mixer

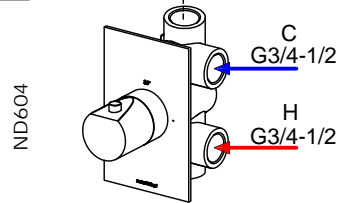

Rubinetto da arresto
Stop valve

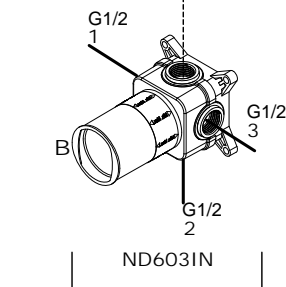
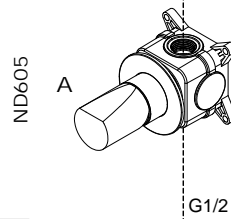

Corpo ad incasso per Art. ND603
Concealed valve for Art. ND603

Deviatore a tre vie
Three way diverter

