

ESSENTIAL

Studio expormim

Tumbona “Rimini” / chaise longue

C850

OUT



Colección fabricada en tubo de aluminio de alta resistencia y tejida a mano artesanalmente con fibra sintética redonda (2 mm de sección) de polietileno de alta densidad (HDPE). Las mesas de centro se sirven con un sobre de cristal templado negro translúcido de 8 mm de espesor.

Collection made of high resistance aluminium tube and hand-woven synthetic round fibre (2 mm width) of high density polyethylene (HDPE). Coffee tables have black tempered glass top (8 mm thick).

Medidas / Dimensions	81 x 208 x 32 cm 32" x 82" x 12.5"
Peso / Weight	12 kg / 26.5 lb
Volumen / Volume	0,54 m ³ / 19.07 ft ³

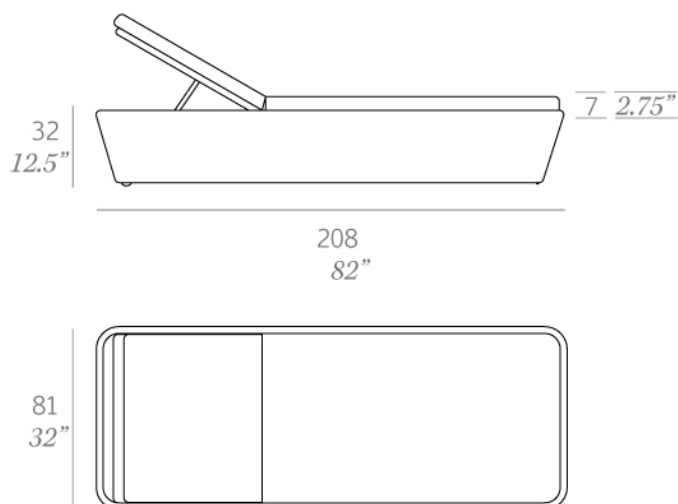

HDPE - Fibras sintéticas / synthetic fibres

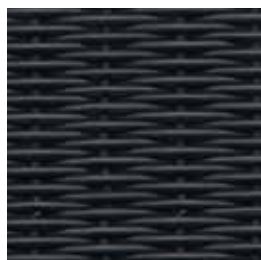

085 black matt

Serie 2 - Confección / cushions

Duo Outdoor



Duo 54

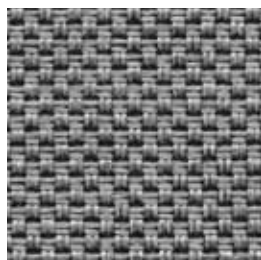

Duo 51



Duo 14

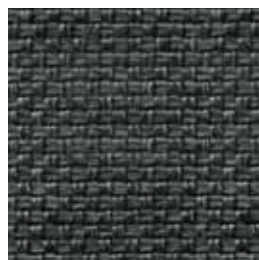

Duo 53



Duo 55

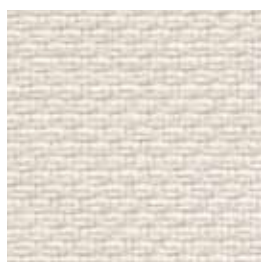

Duo 01

Serie 1 - Confección / cushions

Tempotest®



Marine C



Marine BG



Marine GC

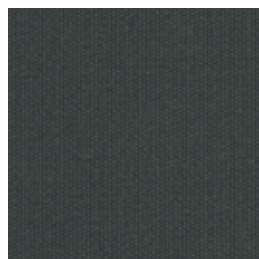

Marine G



Marine GN



Marine M

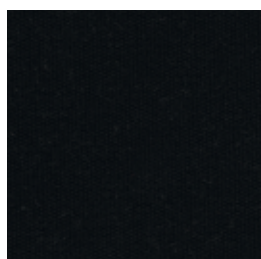

Marine NE



Marine MO



Marine A



Marine VN

Serie 2 - Confección



Marivent 23



Marivent 40



Marivent 42



Marivent 44



Marivent 24



Marivent 41



Marivent 43

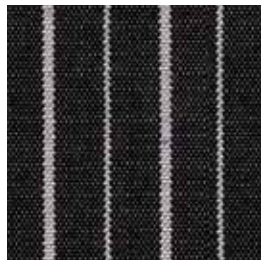

Marivent 45