

Features

- End drain.
- Integral lumbar support and armrests for comfort.
- Textured bottom surface.
- Coordinates with other products in the Devonshire collection.
- 60" (1524 mm) x 32" (813 mm) x 20" (508 mm)

Material

- Acrylic.

Installation

- Drop-in.

Recommended Products/Accessories

- K-7161-AF 1-1/2" adjustable pop-up drain above- or through-floor
- K-7213 27" Cable Bath Drain
- K-7214 27" Cable Bath Drain
- K-24916 Wireless Music Kit
- K-7259 Brass toe tap bath drain
- K-702200-G54 Frameless Sliding Bath Door
- K-702200-G73 Frameless Sliding Bath Door
- K-702200-L Frameless Sliding Bath Door
- K-702205-L Frameless Sliding Bath Door
- K-706000-D3 Frameless Sliding Bath Door
- K-706000-L Frameless Sliding Bath Door
- K-706003-L Frameless Sliding Bath Door
- K-706004-D3 Frameless Sliding Bath Door
- K-706004-L Frameless Sliding Bath Door
- K-706007-L Frameless Sliding Bath Door
- K-1177 Vinyl Tiling-in Bead
- K-23726 Drain treatment
- K-23732 Tub & shower cleaner



Codes/Standards





- CSA B45.5/IAPMO Z124
- ASTM E162
- ASTM E662

KOHLER® Plastic Baths and Receptors Lifetime Limited Warranty

See website for detailed warranty information.

Available Colors/Finishes

Color tiles intended for reference only.

Color	Code	Description
	0	White
	96	Biscuit
	47	Almond
	NY	Dune
	G9	Sandbar

No change in measurements if connected with drain illustrated. (K-7161-AF)

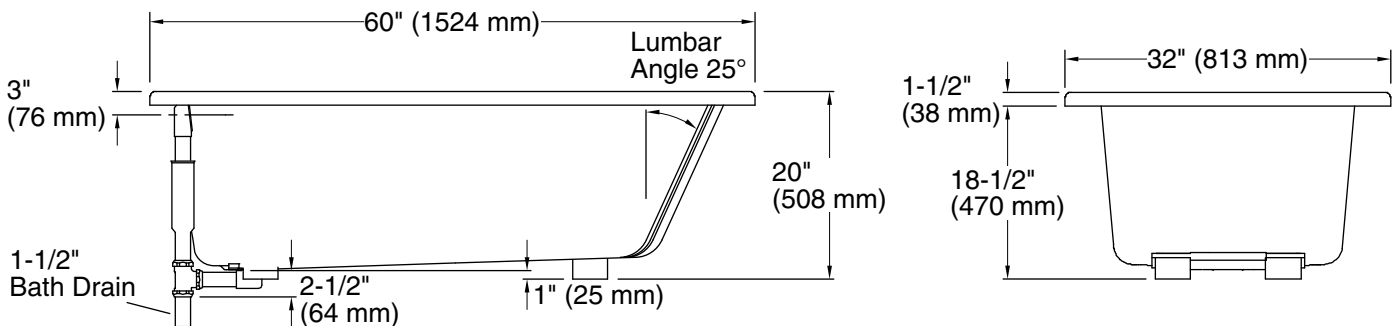
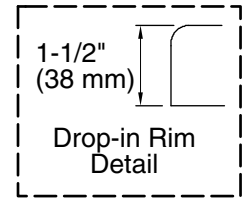
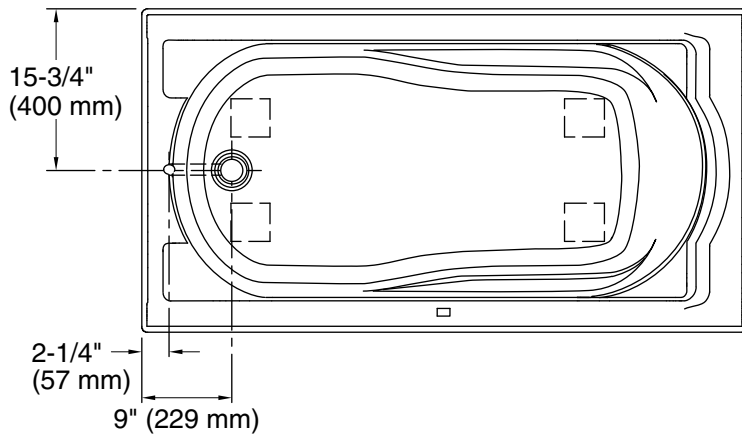

Technical Information

All product dimensions are nominal.

Installation:	Drop-in
Drain location:	End
Basin area, bottom:	42" x 20" (1067 mm x 508 mm)
Basin area, top:	51" x 24" (1295 mm x 610 mm)
Weight:	70 lbs (31.8 kg)
Minimum floor load:	41 lbs/ft ² (200.2 kg/m ²)
Water depth:	14" (356 mm)
Water capacity:	60 gal (227.1 L)
Cutout:	Drop-in, 58" x 30" (1473 mm x 762 mm)
Minimum flat for door:	2-1/2" (64 mm)

Notes

Measure your actual product for rough-in details.

Install this product according to the installation instructions.

The hot water supply should be 70% of the capacity of the bath or greater. Installations will vary.