

8mm Product Range

Sliding Door



Sizes	Product Code	Height, mm	Colour	Adjustment	Opening Space
1000	SE10	1900	Chrome	950 - 990	378
1100	SE11	1900	Chrome	1050 - 1090	428
1200	SE12	1900	Chrome	1150-1190	478
1400	SE14+SE14D	1900	Chrome	1350 - 1390	578

8mm Product Range

Sliding Door – Exploded Diagram

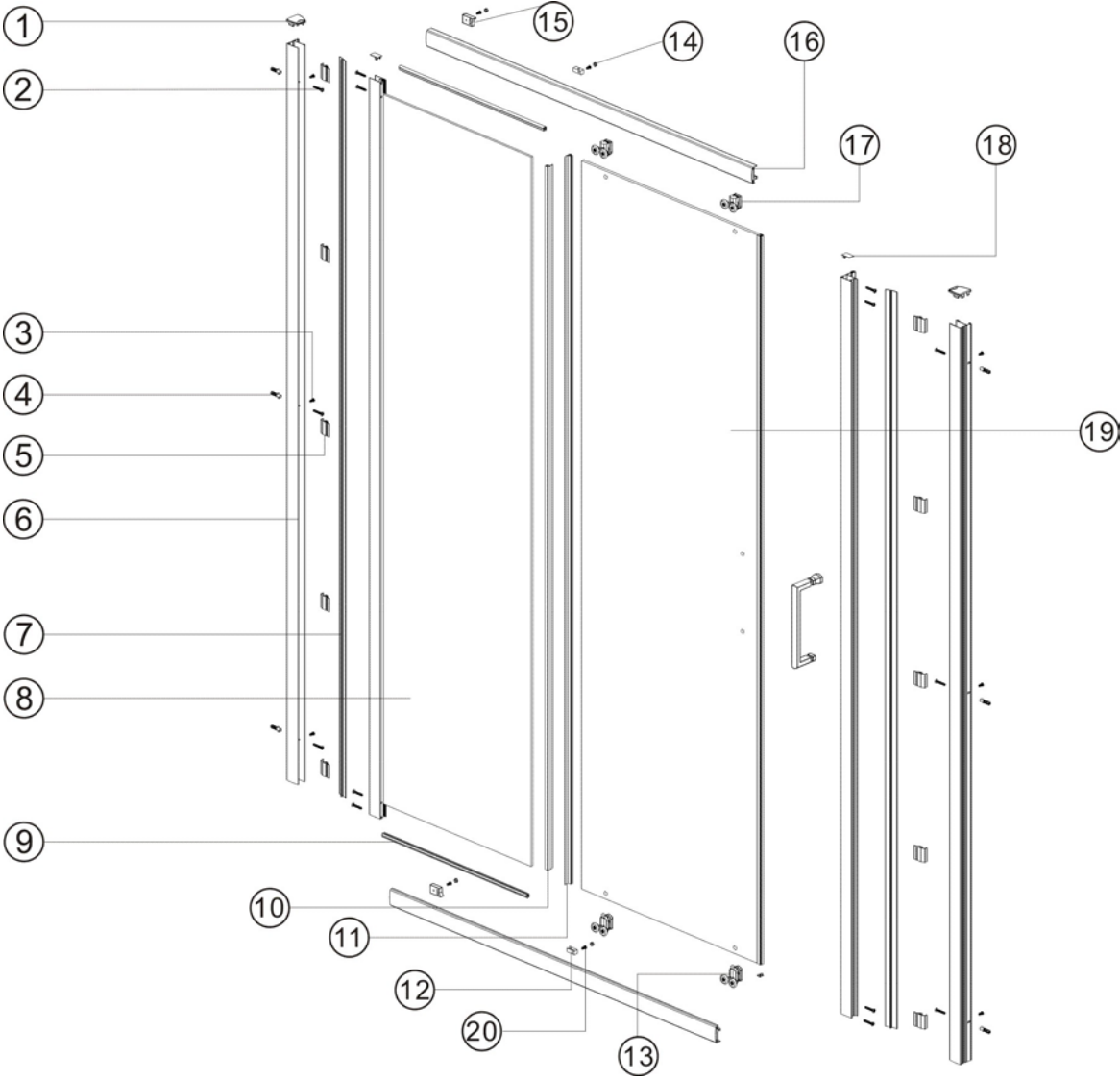





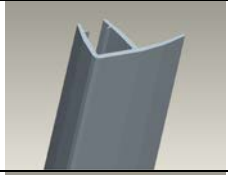
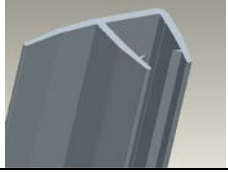

8mm Product Range

Sliding Door – Parts Listing

Item	Part Picture	Name	Spare Part Code	QTY
1		Cover cap for wall profile L/R	B08060 L/R	2
2		Screw ST4*30	A2403001	14
3		Round head screw ST4*12	A2401201	6
4		Ø7*30 wall plug	B08070	6
5		Cover strip clip	B08054	10
6		Wall profile +cover strip clip	B08021	2
7		Cover strip	B08026	2
8		Flat fixed panel	A	1
9		Fixed panel top & bottom seal	B08050	2

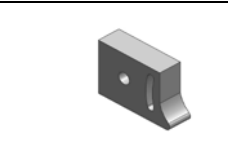
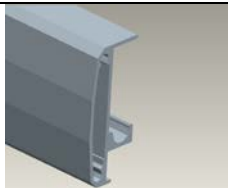
8mm Product Range

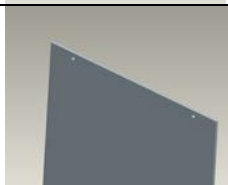
Item	Part Picture	Name	Spare Part Code	QTY
10		Upright seal for fixed panel	B08049	1
11		Upright seal for moving panel	B08080	1
12		Glass clip L/R	B08067 L/R	2
13		Bottom roller	B08075	2
14		Glass clip cover cap	B08069	2
15		Roller stop L/R	B08065 L/R	2
16		Top and bottom rail	B	2
17		Top roller	B08074	2
18		Cover cap for upright profile	B08062	2
19		Moving panel	C	1

8mm Product Range

Item	Part Picture	Name	Spare Part Code	QTY
20		Glass clip and roller stop screw ST4*10	B08089	4