



COMPLEMENTI E ACCESSORI
FURNISHINGS AND ACCESSORIES

ICE
_2005

design
Studio Carlesi Design

vetro extrachiario con schienale verniciato strada lucido
extra-clear glass with back panel lacquered glossy strada



vetro extrachiaro con schienale verniciato opaco grigio piombo e matita
extra-clear glass with back panel lacquered matt grey lead and matita



ICE

vetro bronzo con schienale verniciato ovatta opaco
bronze glass with back panel lacquered matt ovatta



vetro fumé con schienale verniciato matita gofrato
fumed glass with back panel lacquered embossed matita



vetro fumé con schienale verniciato cipria lucido
fumé glass with back panel lacquered glossy cipria



vetro fumé con schienale verniciato creta opaco
fumé glass with back panel lacquered matt creta



Art. ICE4 / 5 / 6

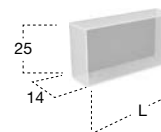

H	P	L	art.
25	14	27	ICE4
25	14	45	ICE5
25	14	72	ICE6

H	P	L	art.
50	14	27	ICE7
75	14	27	ICE8
100	14	27	ICE1
125	14	27	ICE2
150	14	27	ICE3

Art. ICE7

Art. ICE8

Art. ICE1

Art. ICE2

Art. ICE3

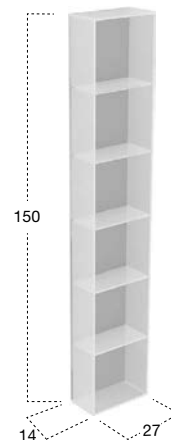
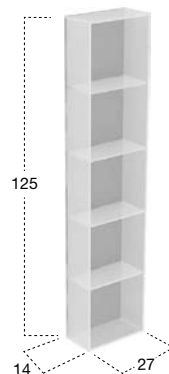
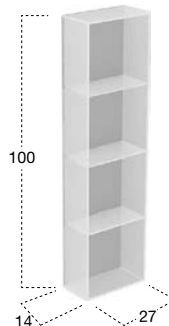
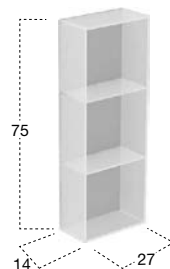
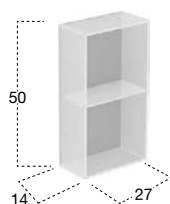

Pensili e colonne a giorno in vetro extrachiaro, vetro bronzo o fumé a 1, 2, 3, 4, 5 e 6 vani con schienale verniciato come da nostra cartella colori laccati.

Open wall cabinets in extra-clear glass, bronze or fumé glass with 1, 2, 3, 4, 5 and 6 compartments and back panel lacquered as per our colour chart.

COMPLEMENTI E ACCESSORI
 FURNISHINGS - ACCESSORIES



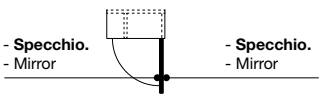

H	P	L	art.
175	19	36	GIANO

Colonna dx o sx con anta a specchio bifacciale, 5 ripiani e un divisorio.

Right or left high cabinet with double faced mirror door, 5 internal shelves and 1 divider.

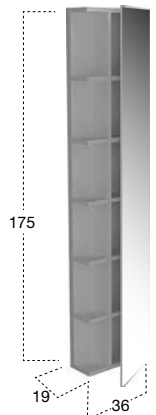



ACCESSORI
ACCESSORIES

OMBRA

_2015

design
Arkimera

Modello e design registrato, brevetto depositato
Registered model and design, patent filed

Gioca sul rapporto tra pieni e vuoti mettendo in luce l'importanza dell'assenza, sottolinea l'essenza del segno conferendogli la terza dimensione, si esprime attraverso un perimetro che si fa volume, nasce dalla forza dell'ombra disegnata sulla parete che "sfonda" la superficie, diventando utile ed elegante contenitore: OMBRA è uno spazio accessorio ottenuto grazie all'incasso di un profilo in alluminio verniciato che permette di creare un vuoto utilizzabile per il posizionamento di tutti gli oggetti e accessori che possono trovare posto nell'ambiente bagno.

Una piccola nicchia funzionale e attrezzabile che può anche essere illuminata, un piccolo palcoscenico domestico sul quale vanno in scena i riti quotidiani legati al benessere quotidiano. Per far questo, gli accessori in tondino metallico verniciato alle polveri e i vassoi in Flumood, trovano posto all'interno dello spazio, personalizzandone l'utilizzo in base alle proprie esigenze e permettendo di trasformarlo rapidamente. Il vano può assumere lo stesso colore della parete per rivelarsi solo da vicino o al contrario differenziarsi cromaticamente dalla superficie, per sottolinearne in modo più incisivo la profondità. Ombra si configura soprattutto come valido aiuto del progettista nella risoluzione architettonica del contenimento degli oggetti. Il sistema ha infatti una vocazione sartoriale: oltre alle misure standard sarà possibile averlo della lunghezza desiderata dal cliente. Disponibile nelle versioni bianca o nera.



A play on the relationship between solid and null, highlighting the importance of the absence is expressed through a perimeter that makes volume, stemming from the strength of the shadow drawn on the wall that breaks through the surface becoming a useful and elegant container: OMBRA is an accessory obtained from a collection of a painted aluminum profiles that allows you to create an empty space used for the positioning of all objects and accessories that can fit in the bathroom.

A small functional niche that can also be illuminated, a small domestic stage for everyday rituals. Lacquered metal rods and the trays in Flumood are placed inside the space to customize your needs. The compartment can have the same color of the wall or otherwise to emphasize depth for a more dramatic effect. Ombra is especially configured as a valid aid to the designer in the architectural resolution of accessorizing. The system has in fact a tailor vocation: in addition to the standard measures it will be possible in custom lengths. Available in black or white.



su richiesta è possibile realizzare la mensola nella lunghezza desiderata.
upon request it is possible to make the shelf in a customized length.









OMBRA

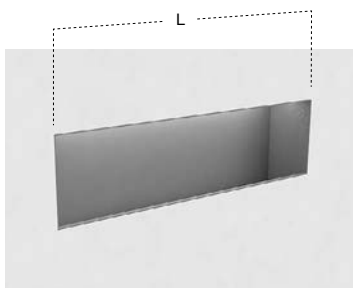
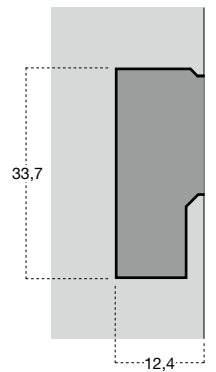

H	P	L	art.	art.
33,7	12,4	da / from 36 a / to 216	OMBRA	OMBRAL Con illuminazione a led / With led lighting

Mensola da incasso a parete con struttura in alluminio bianca o nera, con o senza illuminazione a led.

Recessed wall shelf with white or black aluminum frame, with or without LED lighting.

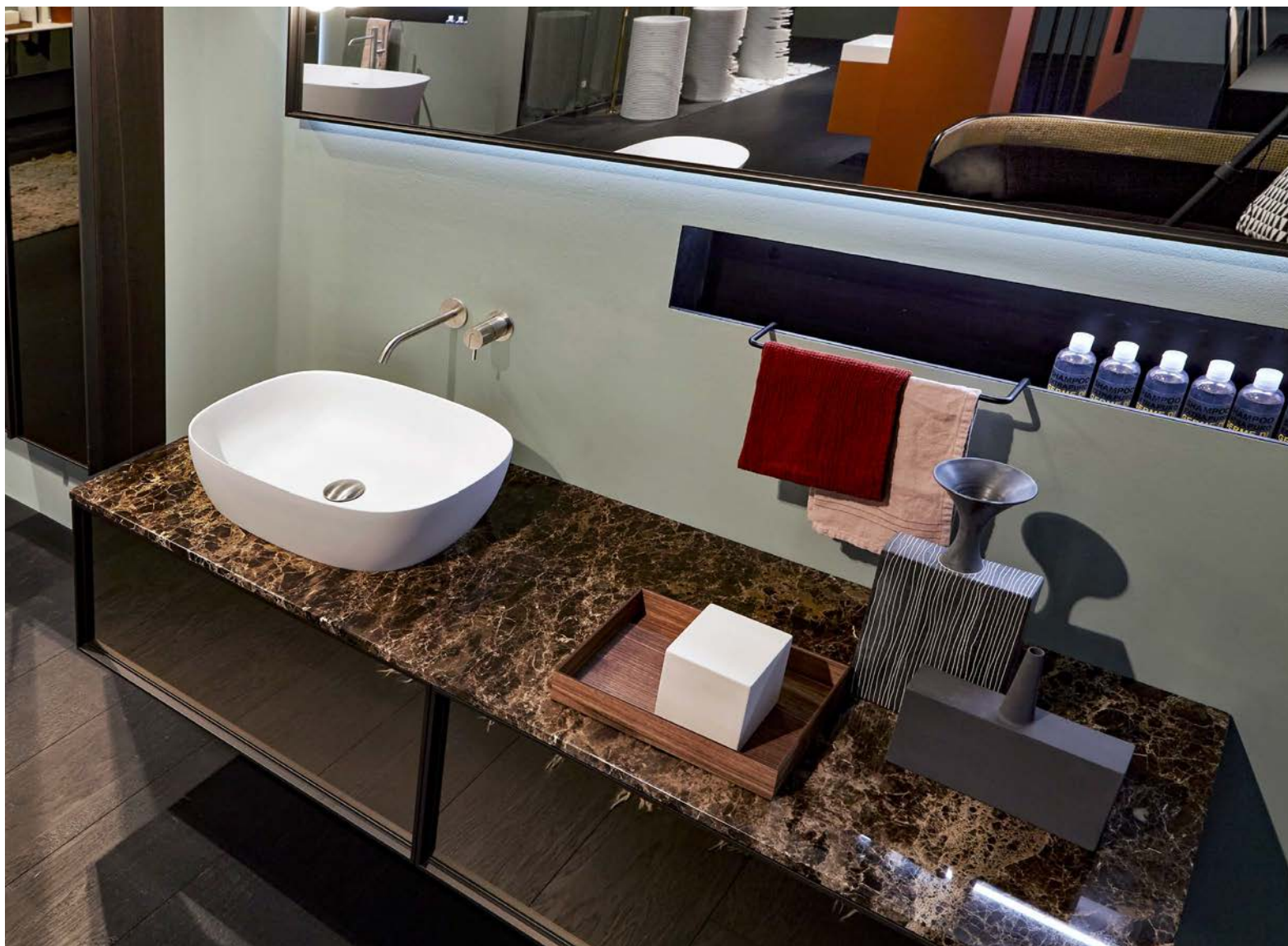

H	P	L	art.
10	12,8	27	OMBRAPS27
		36	OMBRAPS36
		54	OMBRAPS54

Porta salviette in alluminio bianco o nero per mensola Art. OMBRA e Art. OMBRAL.

White or black aluminum towel holder for Art. OMBRA and Art. OMBRAL shelf.

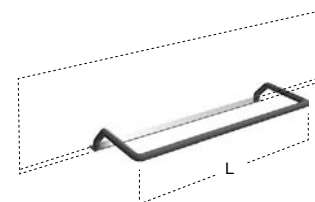

TABULA

_2016

design
Mario
Ferrarini

Modello e design registrato, brevetto depositato
Registered model and design, patent filed



“In principio era Caos soltanto”, scrive Esiodo, poi finalmente è arrivata TABULA, una collezione di pianetti/vassoio in Flumood per organizzare gli oggetti di uso quotidiano in bagno e in qualunque altro ambiente. Componibile, trasportabile, multiuso, resistente agli urti, TABULA si integra e crea ordine, incorniciando e valorizzando gli oggetti.

“In the beginning there was only Chaos”, Esiodo wrote, than TABULA finally arrived, a collection of trays made of Flumood to organize objects of everyday use in the bathroom or any other environment. Modular, portable, multipurpose, shock resistant, TABULA integrates and creates order, framing and enhancing objects.

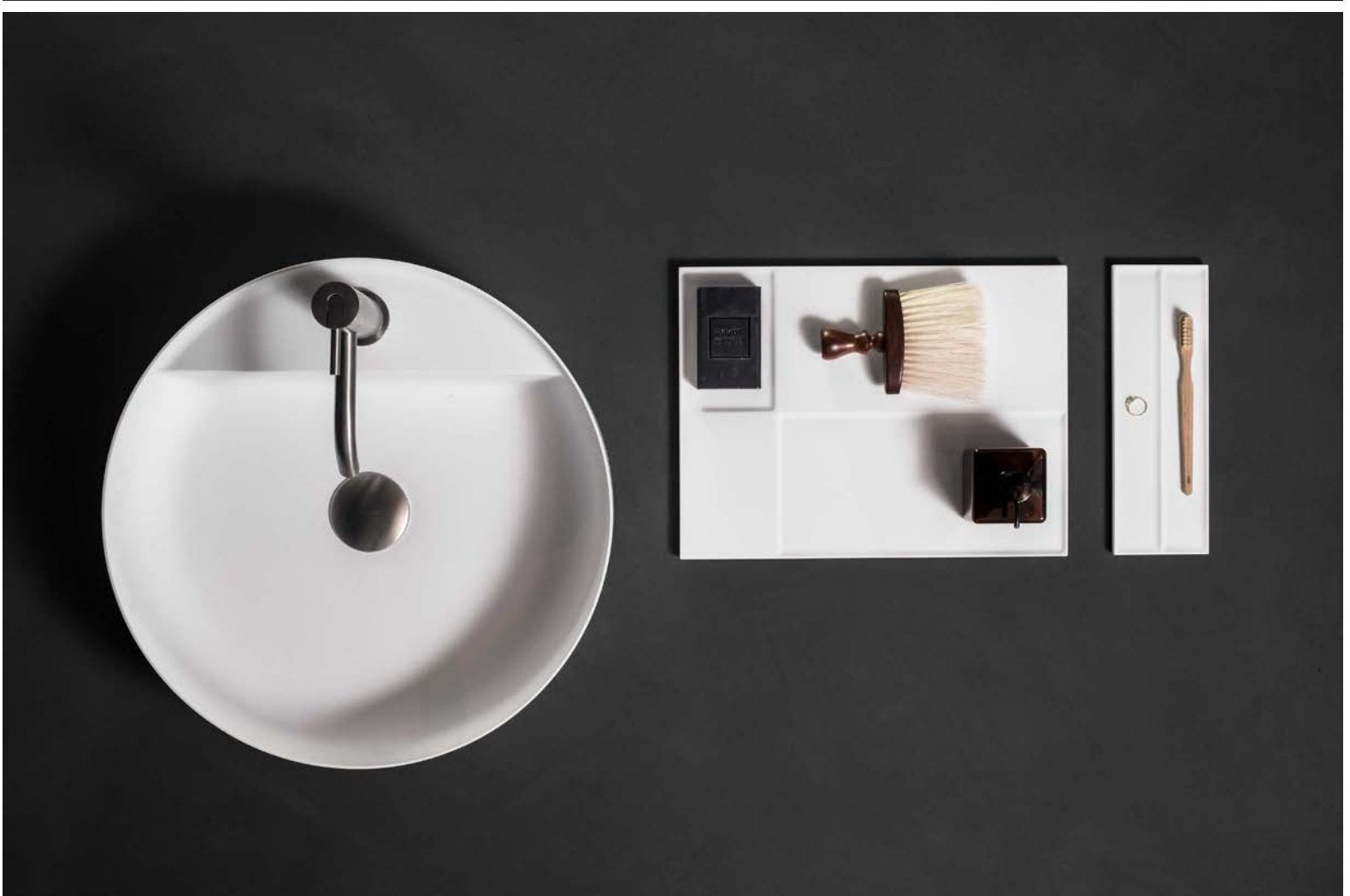



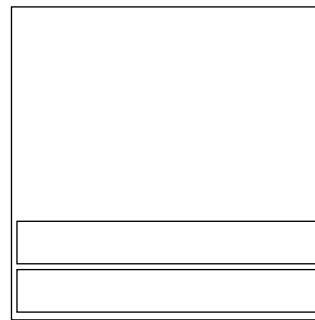

art.TAB1127 cm 27x27x1,2

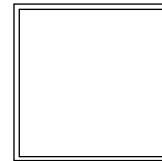

art.TAB213 cm 13,5x13,5x1,2

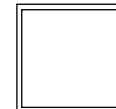

art.TAB209 cm 9x9x1,2

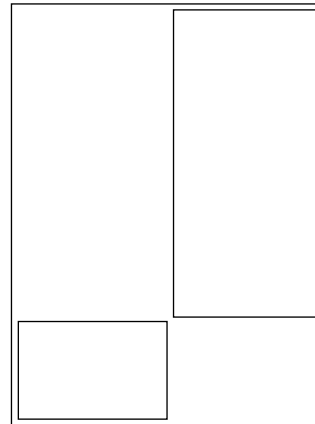

art.TAB3136 cm 27x36x1,2

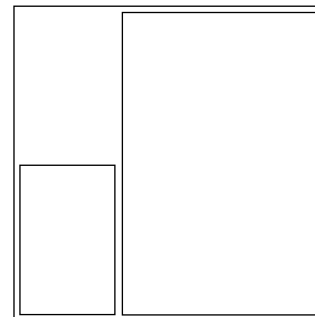

art.TAB4127 cm 27x27x1,2

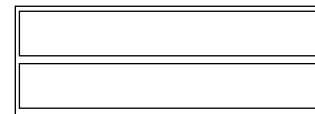

art.TAB5109 cm 27x9x1,2

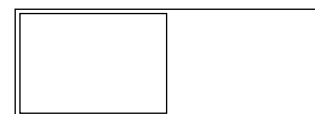

art.TAB6109 cm 27x9x1,2

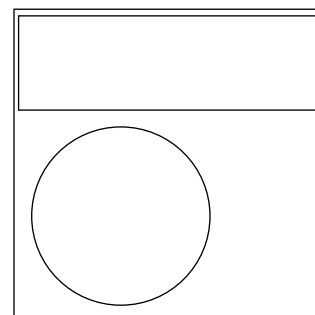

art.TAB7127 cm 27x27x1,2





SESAMO

_2012

design
Arkimera

Modello e design registrato, brevetto depositato
Registered model and design, patent filed

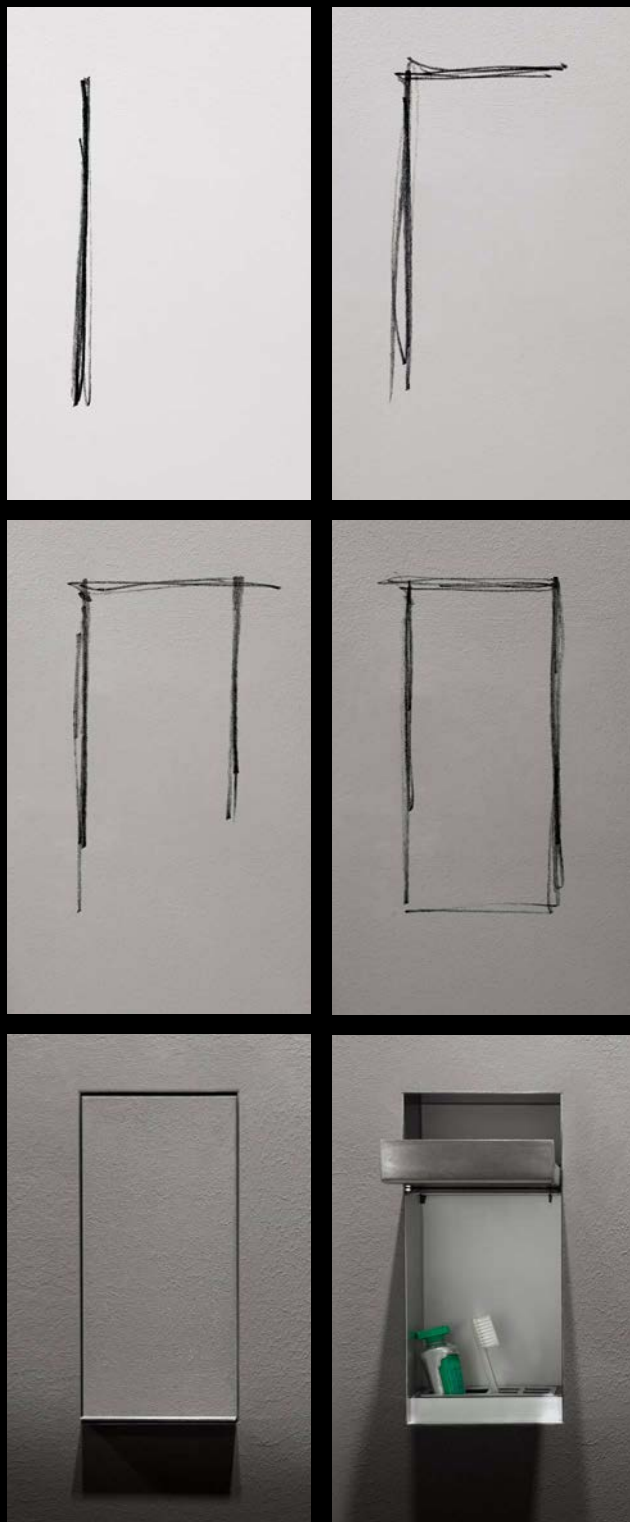

Sesamo è una collezione innovativa che supera il concetto di accessori per il bagno in modo radicale, li mantiene invisibili per poi renderli disponibili al momento dell'utilizzo. Le nicchie sono realizzate in acciaio inox e possono essere rivestite con lo stesso materiale della parete. Nessun limite per il tipo di finitura, massima igiene e funzionalità.

Sesamo is an innovative collection that dramatically goes beyond the concept of bathroom accessories, making them invisible yet available only when necessary. The niches are made of stainless steel and can be coated with the same wall material. No limits to the type of finish, maximum hygiene and functionality.

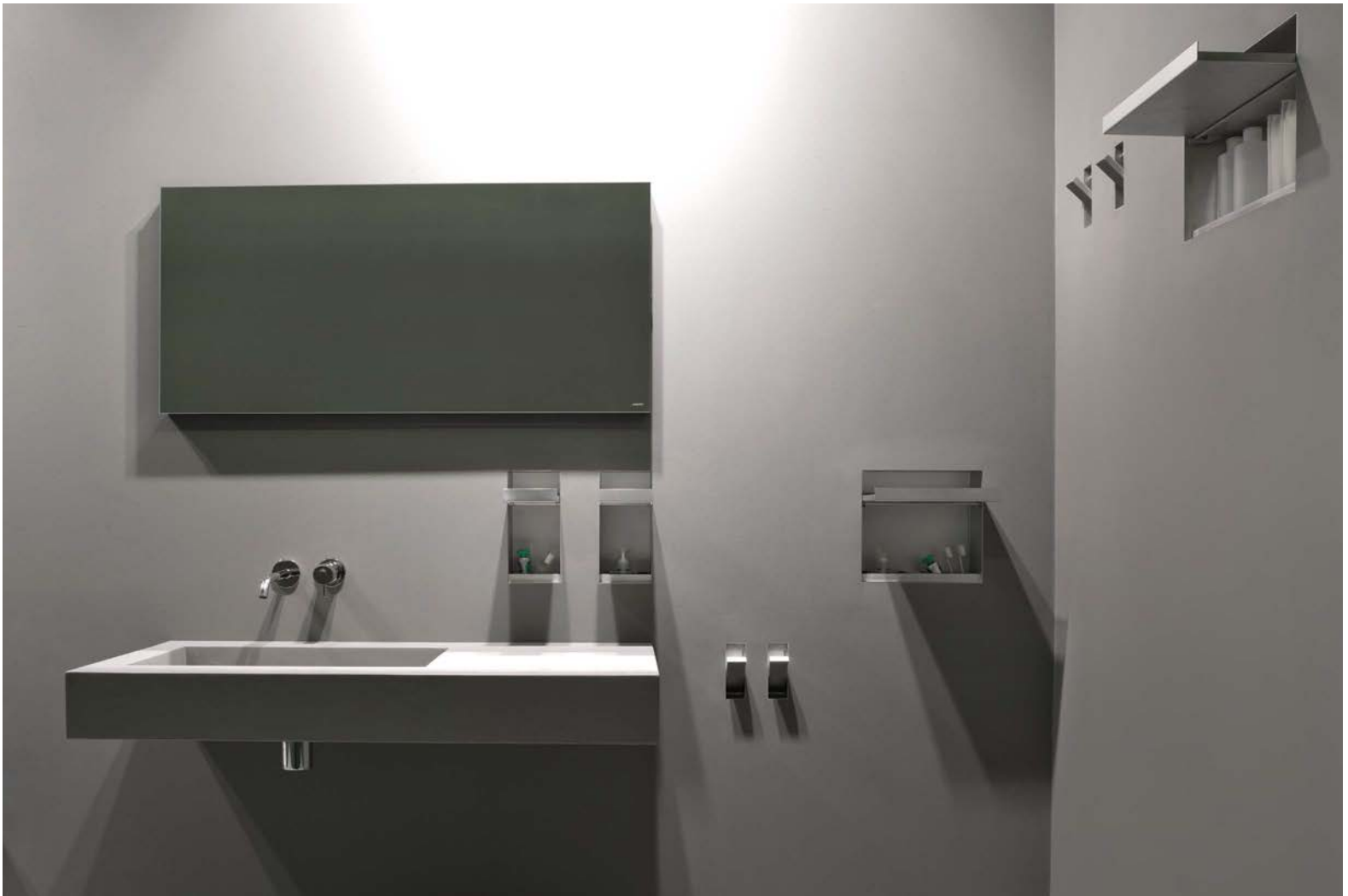
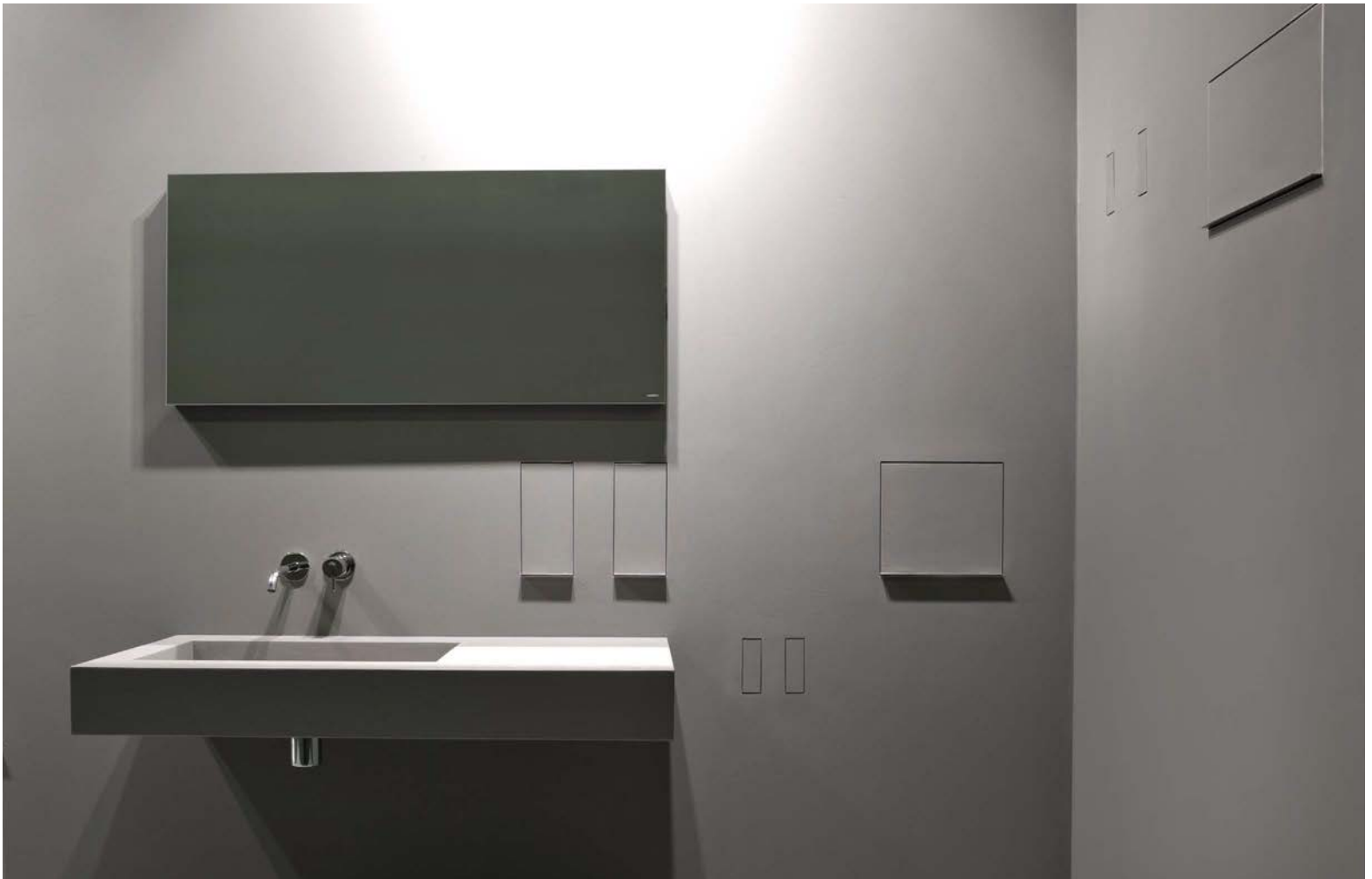

SESAMO





Spesso l'innovazione e la genialità si nascondono nelle cose semplici: Georges de Mestral inventò il velcro nel 1941 osservando, al ritorno da una gita in campagna, gli uncini sul calice dei fiori di bardana che erano rimasti attaccati alla sua giacca, Ruben Rausing utilizzando un sistema di rivestimento plastico della carta riuscì a renderla assolutamente impenetrabile all'aria, ponendo le basi dei contenitori per la conservazione degli alimenti più utilizzati e di un'azienda come la Tetra Pack. Sesamo nel suo piccolo è frutto di un'intuizione altrettanto geniale: osservando le cassette del wc incassate, allo studio Arkimera si è pensato di incassare e rendere invisibili gli accessori, antoniolupi ci ha creduto et voilà è nato Sesamo.

Often innovation and cleverness lie behind simple things: Georges de Mestral invented Velcro in 1941 while observing, upon his return from a trip to the countryside, the seeds of the burdock plant that had attached themselves to his clothes, Ruben Rausing using a type of plastic coated paper was able to make it absolutely impenetrable to air, laying the foundations of containers for food storage of a company like Tetra Pack. Sesamo is the result of an equally brilliant intuition: observing the encased toilet cisterns, the Arkimera studio decided to encase and hide accessories of which antoniolupi supported the idea and voilà, Sesamo was born.



- 1 SESAM05 Porta carta igienica con scorta / Toilet paper holder with spare
- 2 SESAM04 Porta carta igienica / Toilet paper holder - P 10,4 cm
- SESAM041 Porta carta igienica / Toilet paper holder - P 15 cm
- 3 SESAM06 Porta scopino / Toilet brush holder
- 4 SESAM07 Cestino rifiuti / Waste basket
- 5 SESAM02 Porta dispenser/spazzolini / Soap dispenser
- 6 SESAM03 Porta dispenser doppio / Double soap dispenser
- 7 SESAM01 Appendi abiti / Wall hook

SESAMO

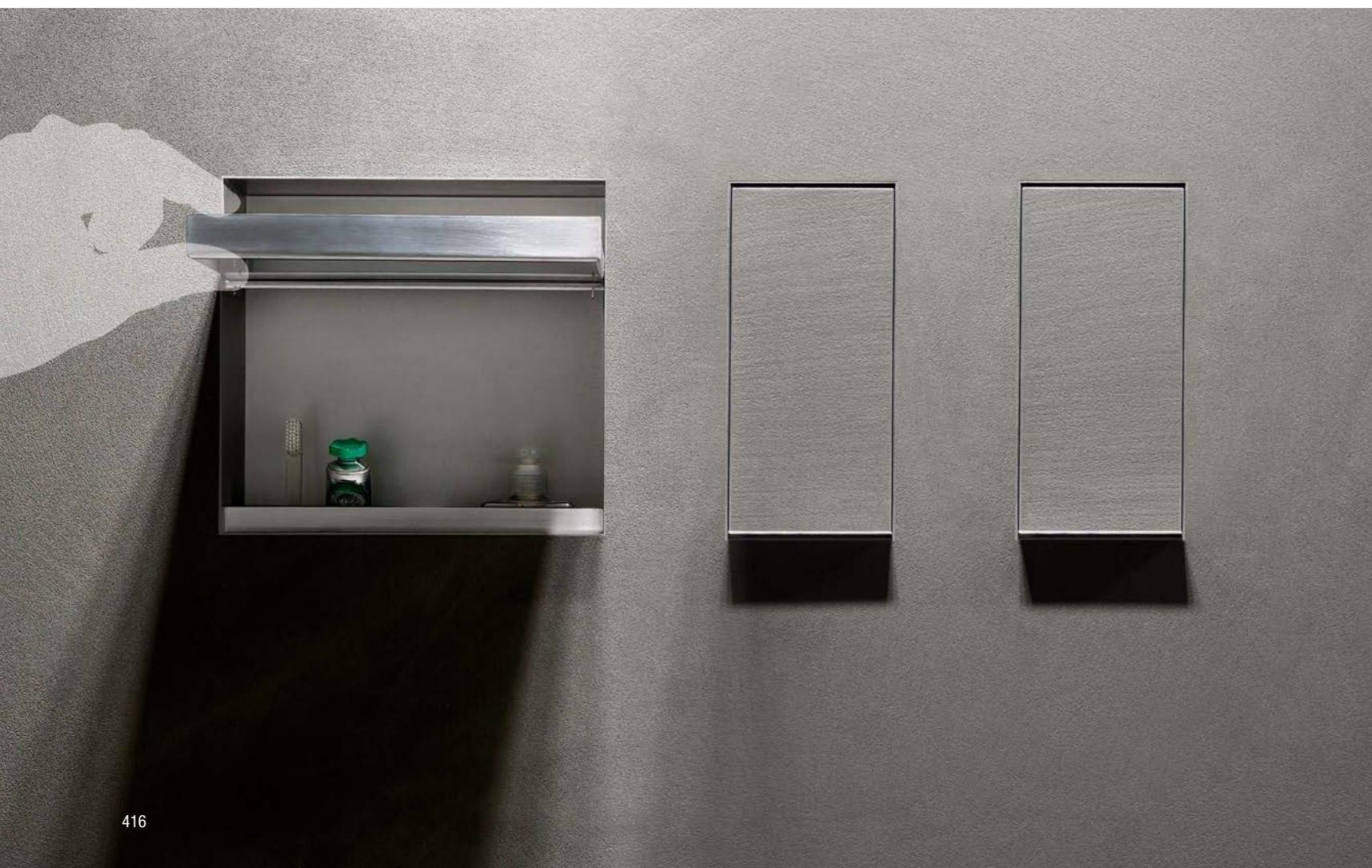
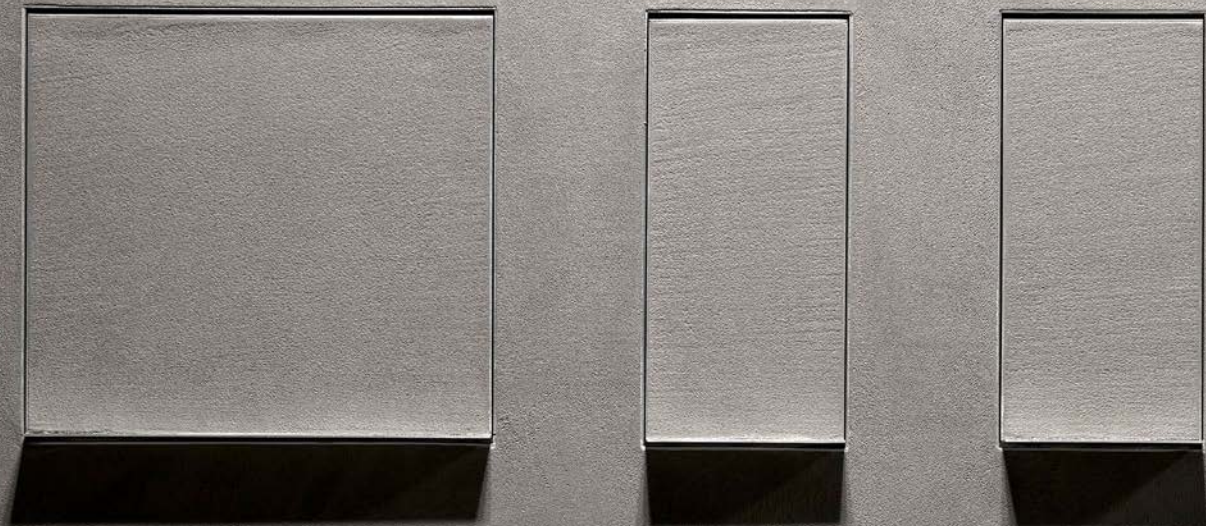

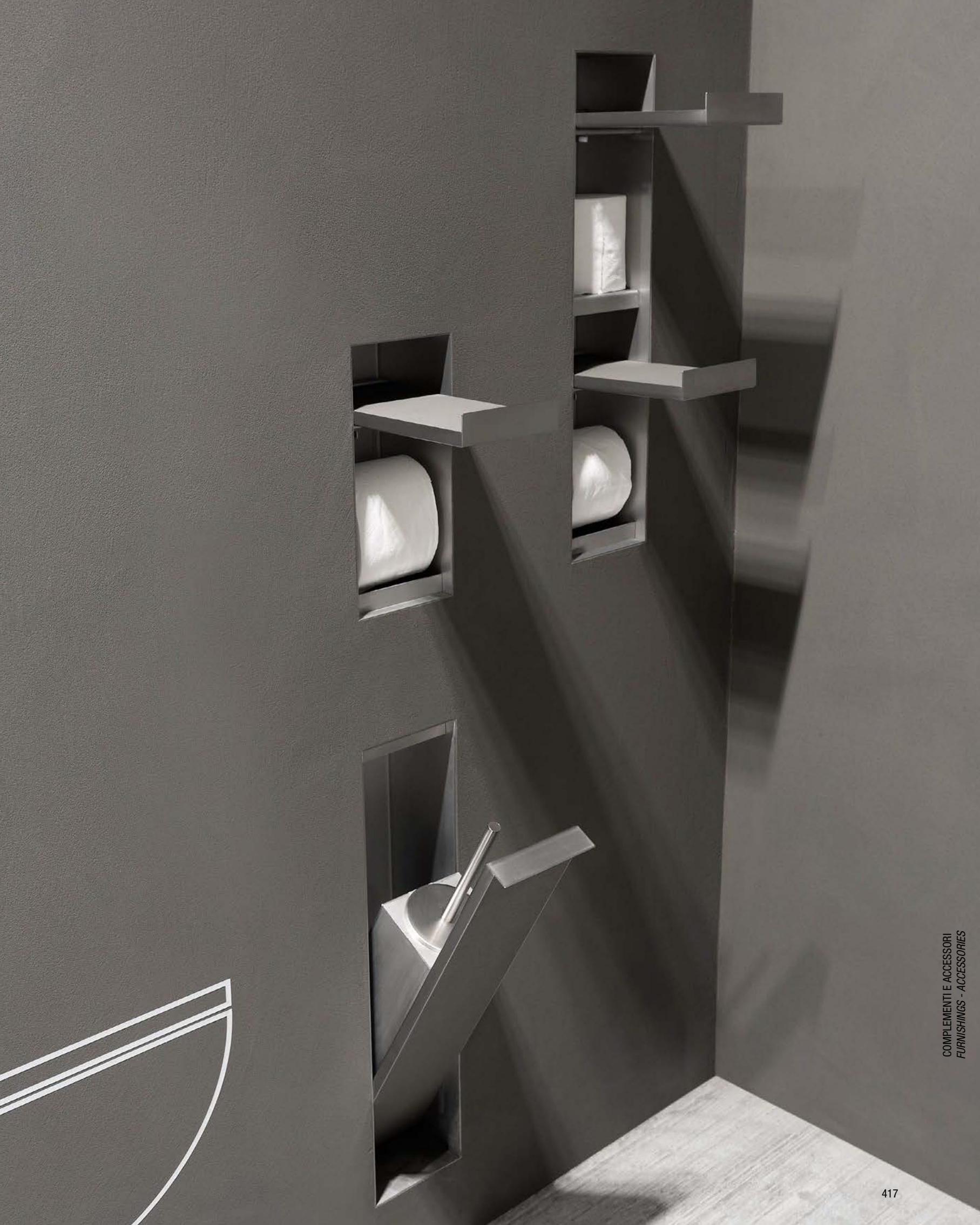



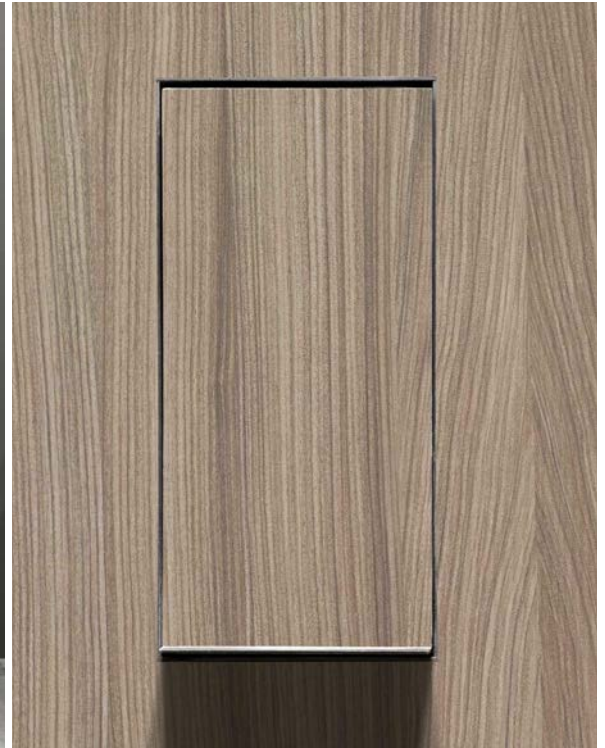

Sentitevi liberi di esprimere il vostro stile

Feel free to express your style

Sentitevi liberi di esprimere il vostro stile, Sesamo si inserisce perfettamente in ogni superficie, diventa pietra, legno, metallo, carta da parati... sentitevi liberi di inventare...
Feel free to express your style, Sesamo fits perfectly into any surface, like stone, wood, metal, wallpaper... feel free to use your imagination ...

SESAMO

Applicazione su cartongesso con finitura intonaco
Application on drywall with plaster finishing

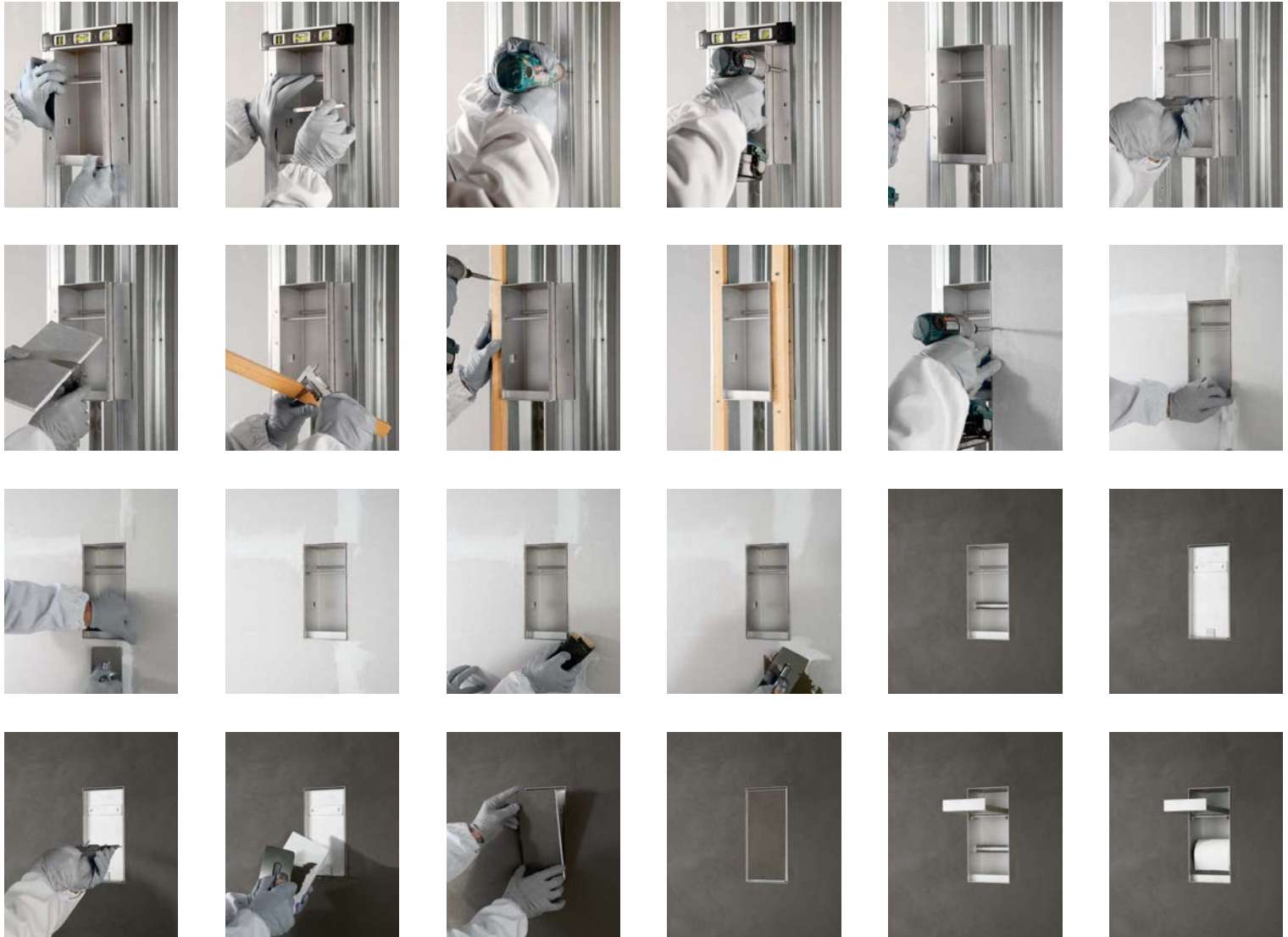

Applicazione su cartongesso con rivestimento marmo
Application on drywall with marble covering

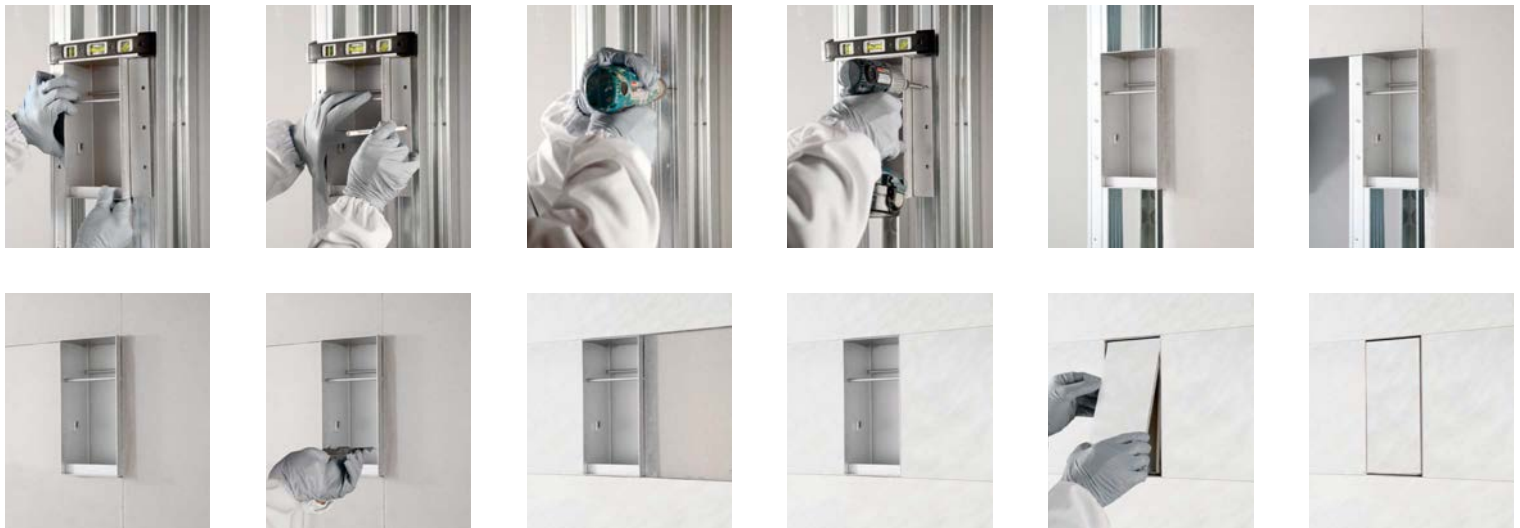

Appendi abiti da incasso a parete in acciaio inox AISI 304 finitura alluminio.

Encased wall hook in stainless steel AISI 304 with an aluminum finish.



H	P	L	art.
12,5	5,5	7,3	SESAM01

Porta dispenser o porta spazzolini da incasso a parete in acciaio inox AISI 304 finitura alluminio.

Encased soap dispenser in stainless steel AISI 304 with an aluminum finish.



H	P	L	art.
31,5	10,4	19,8	SESAM02

Porta scopino da incasso a parete in acciaio inox AISI 304 finitura alluminio.

Encased toilet brush holder in stainless steel AISI 304 with an aluminum finish.



H	P	L	art.
50	10,4	19,8	SESAM06

Porta carta con scorta da incasso a parete in acciaio inox AISI 304 finitura alluminio.

Encased toilet paper holder and spare in stainless steel AISI 304 with an aluminum finish.



H	P	L	art.
50	10,4	19,8	SESAM05

Porta carta da incasso a parete in acciaio inox AISI 304 finitura alluminio.

N.B. Lo spazio utile interno in profondità è di 8,7 cm per Art. SESAM04 e di 13,5 cm per Art. SESAM041.

Encased toilet paper holder in stainless steel AISI 304 with an aluminum finish.

P.S. The internal useful space is 8,7 cm for Art. SESAM04 and is 13,5 cm for Art. SESAM041.



H	P	L	art.
25	10,4	19,8	SESAM04
25	15	19,8	SESAM041

Porta dispenser o porta spazzolini doppio da incasso a parete in acciaio inox AISI 304 finitura alluminio.

Encased double soap dispenser in stainless steel AISI 304 with an aluminum finish.



H	P	L	art.
31,5	10,4	35	SESAM03

Cestino rifiuti da incasso a parete in acciaio inox AISI 304 finitura alluminio.

Encased waste basket in stainless steel AISI 304 with an aluminum finish.



H	P	L	art.
50	10,4	19,8	SESAM07

RETTA

_2011

design
Nevio
Tellatin





Porta salviette in alluminio verniciato bianco, nero opaco o colorato gofrato come da nostra cartella colori laccati.

Towel holder in aluminium lacquered matt white, black or embossed as per our colour chart.

H	P	L	art.
8	5	54	RETTA454
		72	RETTA472
		90	RETTA490
		108	RETTA4108

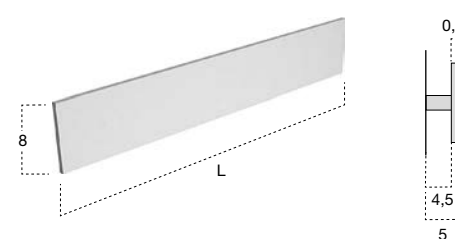

Porta salviette in alluminio verniciato bianco, nero opaco o colorato gofrato come da nostra cartella colori laccati.

Towel holder in aluminium lacquered matt white, black or embossed as per our colour chart.

H	P	L	art.
8	13	54	RETTA1254
		72	RETTA1272
		90	RETTA1290
		108	RETTA12108

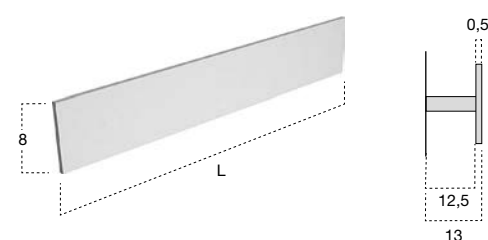

TAPE

_2003

design
Carlo
Colombo

Tutta la serie TAPE é realizzata in acciaio inox satinato AISI 304.
The TAPE series is produced in satin stainless steel AISI 304.





TAPE





TAPE





TAPE 72



TAPE 54



TAPE 45



TAPE 36



TAPE 27

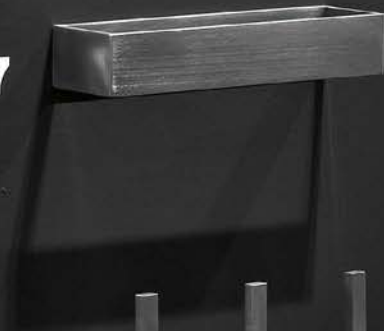

TAPE 113



TAPE ...per esempio...
...for example...

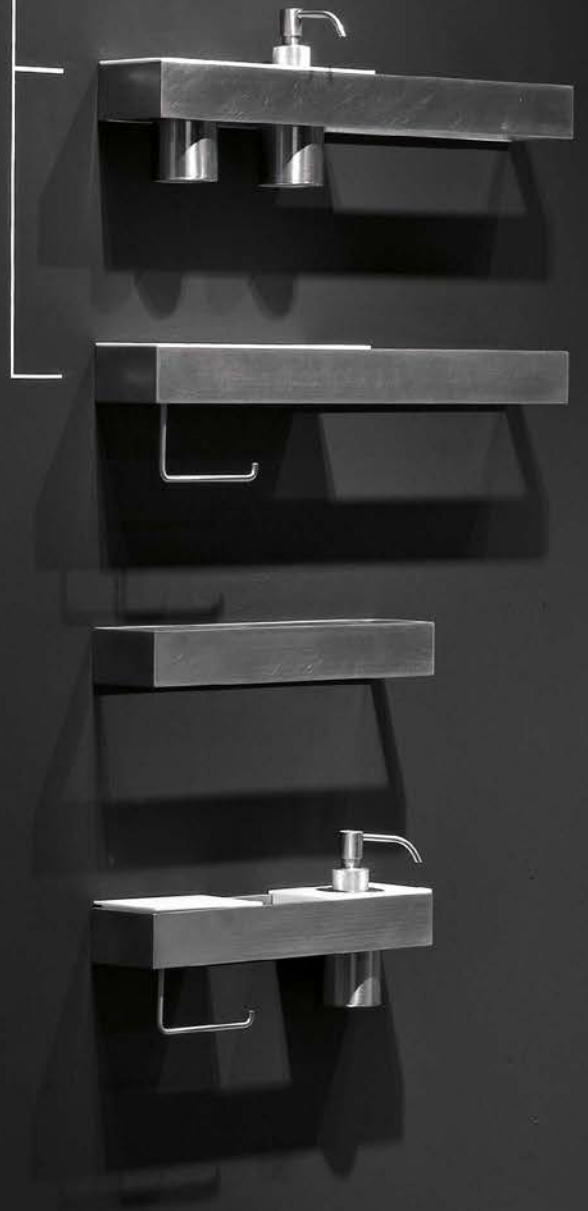



TAPE



Appendi abiti singolo a parete in acciaio inox satinato AISI 304.

Satin stainless steel AISI 304 clothes hook.

H	P	L	art.
6	8	8	TAPE106



Appendi abiti doppio a parete in acciaio inox satinato AISI 304.

Double satin stainless steel AISI 304 clothes hook.

H	P	L	art.
6	8	16	TAPE107



Dispenser sapone liquido da appoggio o da incasso per pianetti Corian in acciaio inox satinato AISI 304.

Freestanding or encased soap dispenser in satin stainless steel AISI 304 for Corian surfaces.

H	P	Ø	art.
16	9,5	6,5	TAPE101



Pianetto in Corian liscio.

Corian surface.

H	P	L	art.
1,2	8	13,5	TAPE1



Bicchiere da appoggio o da incasso per pianetti Corian in acciaio inox satinato AISI 304.

Freestanding or encased cup in satin stainless steel AISI 304 for Corian surfaces.

H	P	Ø	art.
10,5	6,5	6,5	TAPE102



Porta scopino da appoggio in resina bianca e manico in acciaio inox satinato AISI 304.

Toilet brush and white resin holder with a satin stainless steel AISI 304 handle.

H	P	Ø	art.
44	8	8	TAPE113

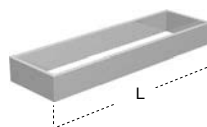

Porta salviette in acciaio inox satinato AISI 304.

Satin stainless steel AISI 304 towel rack.

H	P	L	art.
5	8	27	TAPE27
		36	TAPE36
		45	TAPE45
		54	TAPE54
		72	TAPE72



Pianetto in Corian liscio dx o sx reversibile, con portarotolo in acciaio inox satinato AISI 304.

Corian surface right or left with satin stainless steel AISI 304 paper roll holder.

H	P	L	art.
12	8	13,5	TAPE2

Porta sapone in Corian.

Corian soap dish.



H	P	L	art.
1,2	8	13,5	TAPE3

Porta sapone in Corian dx o sx reversibile, con portarotolo in acciaio inox satinato AISI 304.

Corian soap dish right or left with satin stainless steel AISI 304 paper roll holder.



H	P	L	art.
12	8	13,5	TAPE4

Pianetto in Corian con foro per bicchiere o dispenser.

Corian surface with hole for cup or dispenser.



H	P	L	art.
1,2	8	13,5	TAPE5

Pianetto in Corian con griglia.

Grided Corian surface.



H	P	L	art.
1,2	8	13,5	TAPE6

Pianetto in Corian liscio.

Corian surface.



H	P	L	art.
1,2	8	27	TAPE11

Pianetto in Corian con foro per bicchiere o dispenser.

Corian surface with hole for cup or dispenser.



H	P	L	art.
1,2	8	27	TAPE12

Pianetto in Corian con 2 fori per bicchiere o dispenser.

Corian surface with 2 holes for cup or dispenser.



H	P	L	art.
1,2	8	27	TAPE13

Pianetto in Corian con griglia.

Grided Corian surface.



H	P	L	art.
1,2	8	27	TAPE14

PLAY

_2005

design
AL Studio

La collezione PLAY é in acciaio inox lucido AISI 304 o in alluminio finitura zirconio, bronzo, titanio e champagne

The PLAY Collection is in polished stainless steel AISI 304 or aluminum available in finishes zirconio, bronzo, titanio and champagne.



ZIRCONIO



BRONZO



TITANIO



CHAMPAGNE

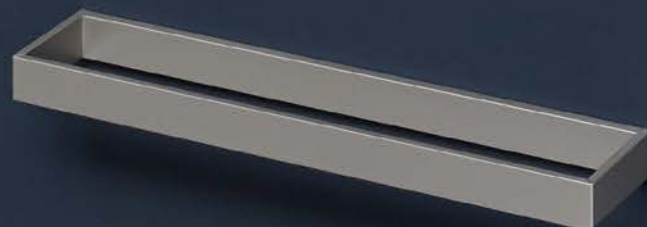













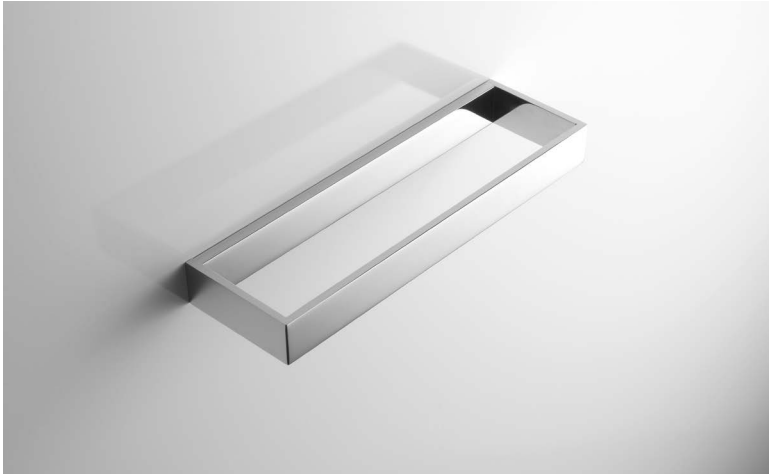

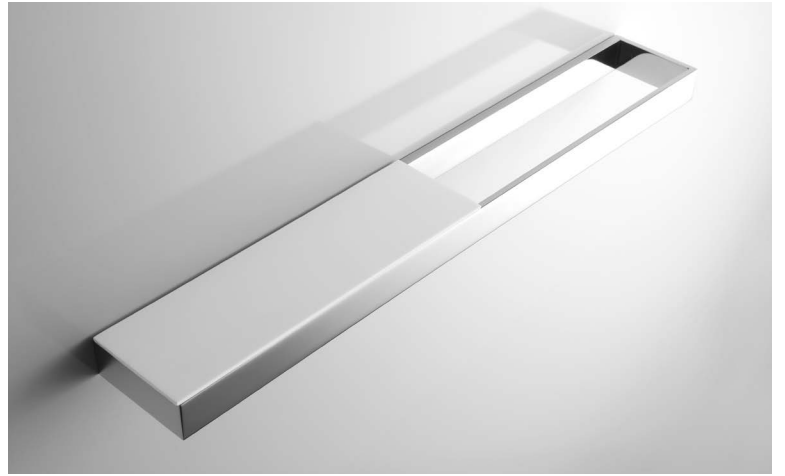
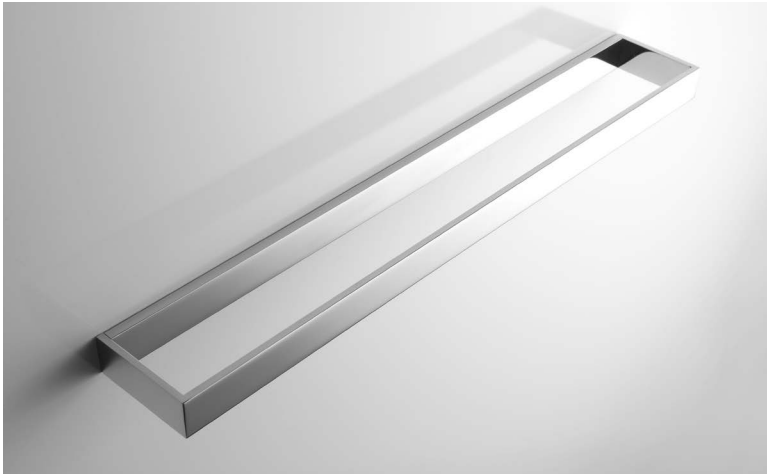

PLAY

Appendi abiti singolo a parete in acciaio inox lucido AISI 304 o in alluminio finitura come da nostro campionario colori.

Clothes hook in polished stainless steel AISI 304 or aluminum finish as per our color samples.



H	P	L	art.
3	8	6	PLAY106

Appendi abiti doppio a parete in acciaio inox lucido AISI 304.

Double polished stainless steel AISI 304 clothes hook.



H	P	L	art.
3	8	12	PLAY107

Dispenser sapone liquido da appoggio o da incasso per pianetti Corian in acciaio inox lucido AISI 304.

Freestanding or encased soap dispenser for Corian surfaces in polished stainless steel AISI 304.



H	P	Ø	art.
16	9,5	6,5	PLAY101

Bicchiere da appoggio o da incasso per pianetti Corian in acciaio inox lucido AISI 304.

Freestanding or encased cup for Corian surfaces in polished stainless steel AISI 304.



H	P	Ø	art.
10,5	6,5	6,5	PLAY102

Porta scopino da appoggio in resina bianca e manico in acciaio inox lucido AISI 304.

Toilet brush and white resin holder with a polished stainless steel AISI 304 handle.



H	P	Ø	art.
44	8	8	PLAY113

Porta salviette in acciaio inox lucido AISI 304 o in alluminio finitura come da nostro campionario colori.

Towel rack in polished stainless steel AISI 304 or aluminum finish as per our color samples.

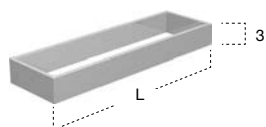

H	P	Ø	art.
3	8	27	PLAY27
		40	PLAY40
		54	PLAY54
		72	PLAY72

Pianetto in Corian liscio.

Corian surface.



H	P	L	art.
1,2	8	13,5	TAPE1

Pianetto in Corian liscio dx o sx reversibile, con portarotolo in acciaio inox lucido AISI 304 o in alluminio finitura come da nostro campionario colori.

Corian surface with right or left paper roll holder in polished stainless steel AISI 304 or aluminum finish as per our color samples.



H	P	L	art.
10	8	13,5	PLAY2

Porta sapone in Corian.

Corian soap dish.



H	P	L	art.
1,2	8	13,5	TAPE3

Porta sapone in Corian dx o sx reversibile, con portarotolo in acciaio inox lucido AISI 304 o in alluminio finitura come da nostro campionario colori.

Corian soap dish with right or left paper roll holder in polished stainless steel AISI 304 or aluminum finish as per our color samples.



H	P	L	art.
10	8	13,5	PLAY4

Pianetto in Corian con foro per bicchiere o dispenser.

Corian surface with hole for cup or dispenser.



H	P	L	art.
1,2	8	13,5	TAPE5

Pianetto in Corian con griglia.

Grided Corian surface.



H	P	L	art.
1,2	8	13,5	TAPE6

Pianetto in Corian liscio.

Corian surface.



H	P	L	art.
1,2	8	27	TAPE11

Pianetto in Corian con foro per bicchiere o dispenser.

Corian surface with hole for cup or dispenser.



H	P	L	art.
1,2	8	27	TAPE12

Pianetto in Corian con 2 fori per bicchiere o dispenser.

Corian surface with 2 holes for cup or dispenser.



H	P	L	art.
1,2	8	27	TAPE13

Pianetto in Corian con griglia.

Gridded Corian surface.



H	P	L	art.
1,2	8	27	TAPE14

Bicchieri da appoggio in resina bianca.

White resin cup.



H	P	Ø	art.
12	8	8	JUST1

Porta sapone da appoggio in resina bianca.

White resin soap dish.



H	P	L	art.
3	8	12	JUST3

Dispenser sapone liquido da appoggio in resina bianca e acciaio inox lucido AISI 304.

White and polished stainless steel AISI 304 resin soap dispenser.



H	P	Ø	art.
19	11	8	PLAY6

Bicchiere in resina bianca con supporto a parete in acciaio inox lucido AISI 304.

White resin cup with polished stainless steel AISI 304 wall support.



H	P	Ø	art.
15	11,2	8	PLAY11

Dispenser sapone liquido in resina bianca con supporto a parete in acciaio inox lucido AISI 304.

White resin soap dispenser with polished stainless steel AISI 304 wall support.



H	P	Ø	art.
22	14,2	8	PLAY14

Piantana porta carta, porta salviette doppio in acciaio inox lucido AISI 304 con porta scopino in resina bianca.

Freestanding polished stainless steel AISI 304 double paper roll or towel rack with white resin toilet brush and holder.



H	P	L	art.
60	21,5	33	PLAY136

JUST

_2007

design
AL Studio

Tutta la serie JUST é realizzata in acciaio inox satinato AISI 304.
The JUST series is produced in satin stainless steel AISI 304.

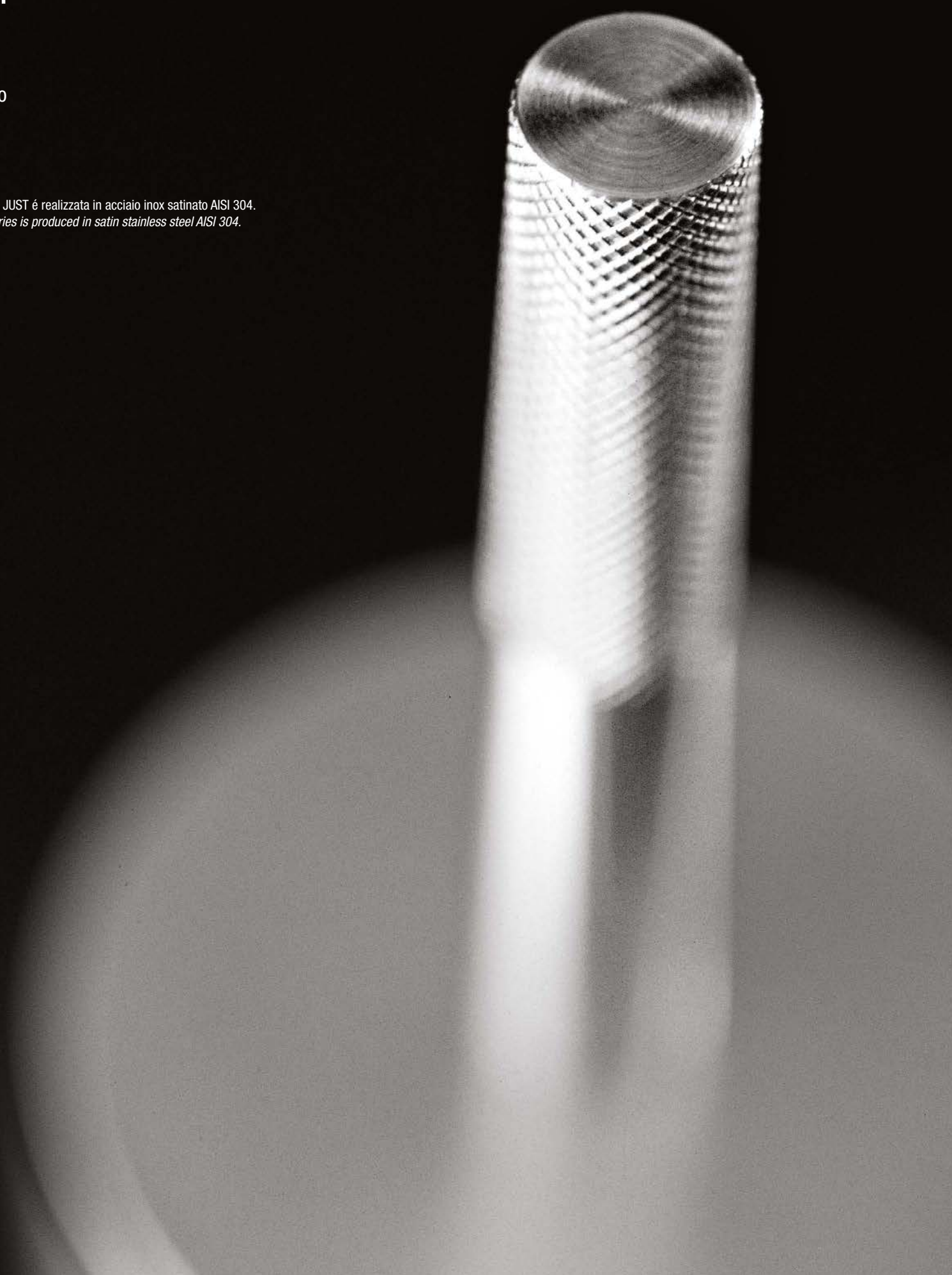

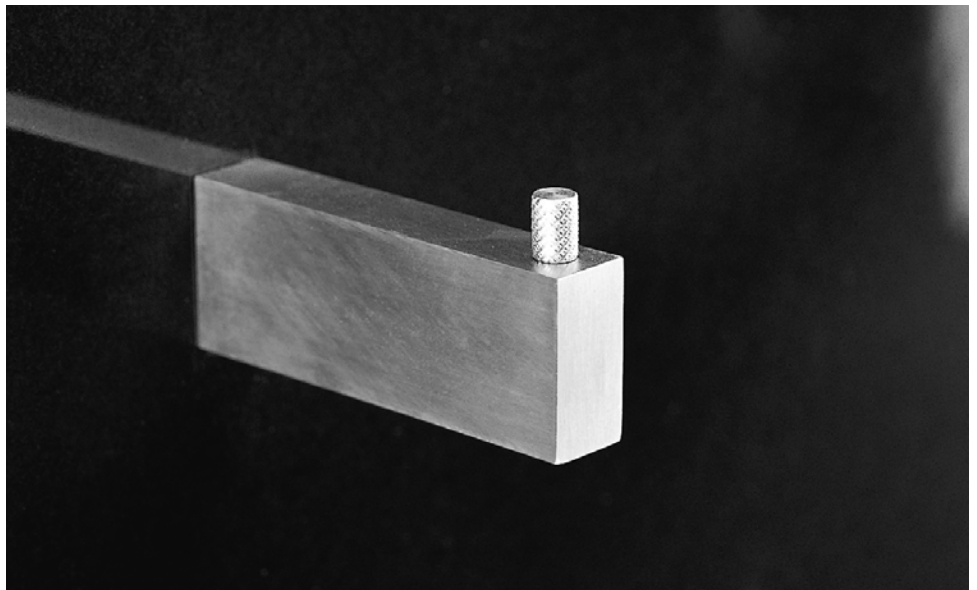
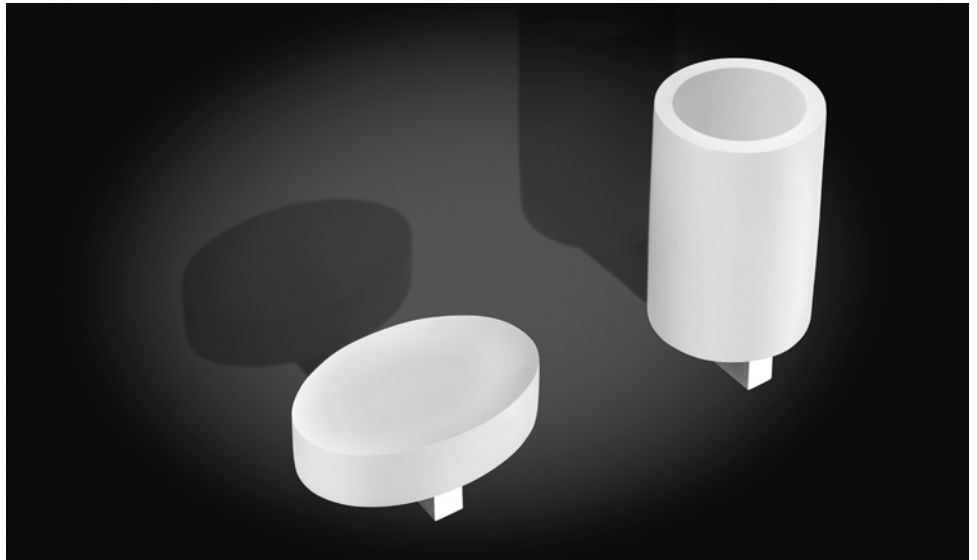



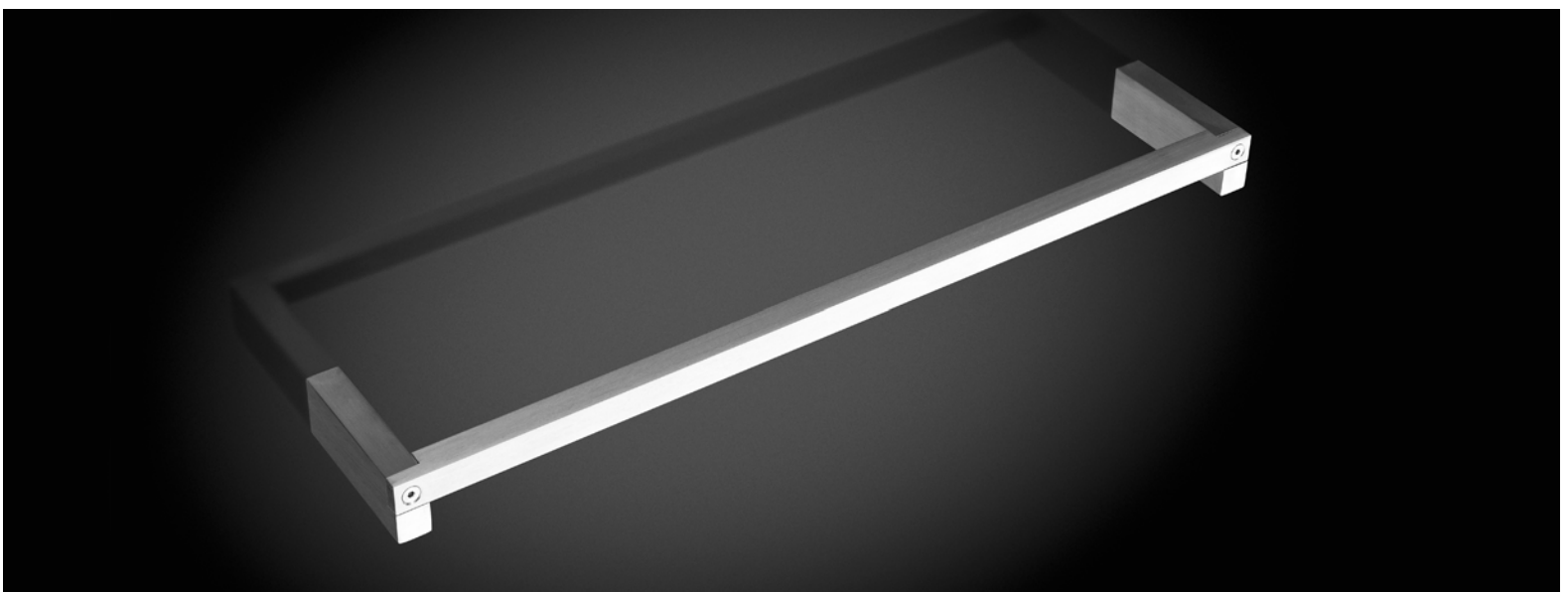
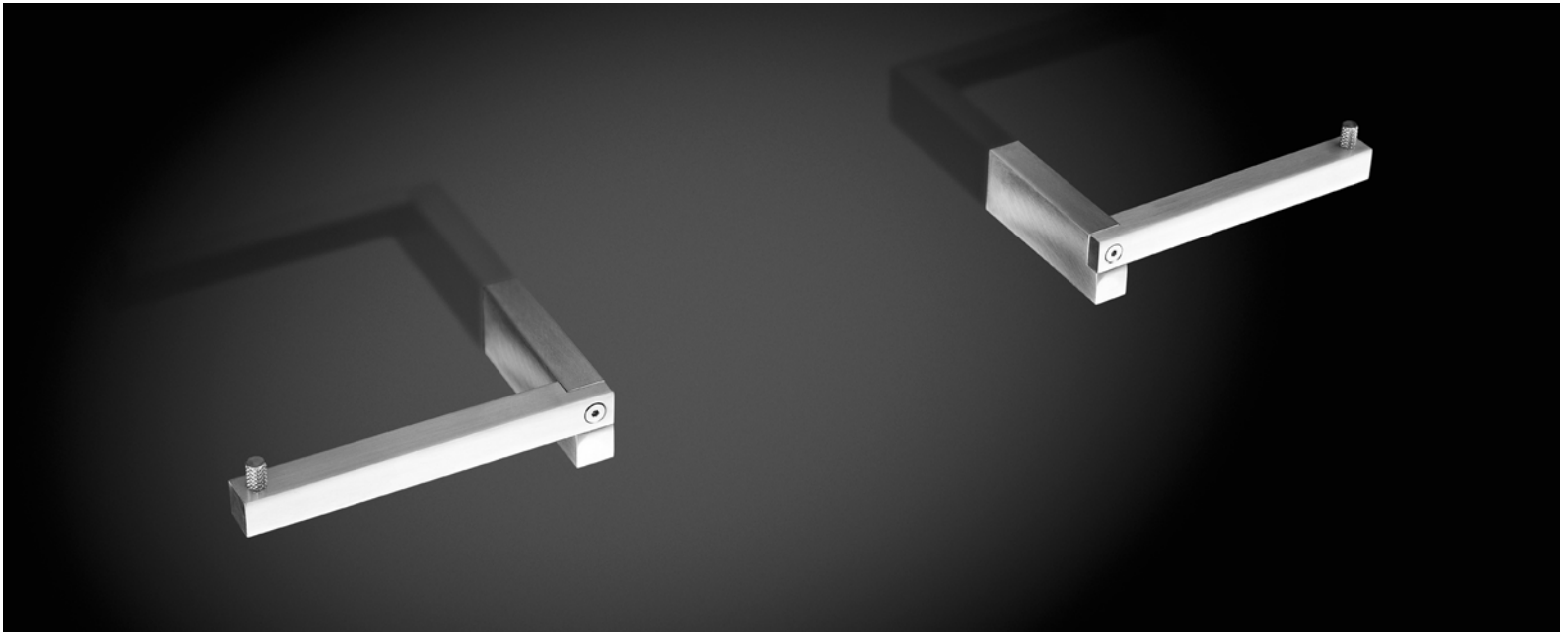



Bicchiere da appoggio in resina bianca.

White resin cup.



H	P	Ø	art.
12	8	8	JUST1

Porta sapone da appoggio in resina bianca.

White resin soap dish.



H	P	L	art.
3	8	12	JUST3

Dispenser sapone liquido da appoggio in resina bianca e acciaio inox satinato AISI 304.

White resin and satin stainless steel AISI 304 soap dispenser.



H	P	Ø	art.
19	11	8	JUST4

Porta scopino da appoggio in resina bianca e manico in acciaio inox satinato AISI 304.

White resin and satin stainless steel AISI 304 toilet brush and holder.



H	P	Ø	art.
44	8	8	JUST6

Bicchiere in resina bianca con supporto a parete in acciaio inox satinato AISI 304.

White resin cup with satin stainless steel AISI 304 wall support.



H	P	Ø	art.
15	11,2	8	JUST11

Dispenser sapone liquido in resina bianca con supporto a parete in acciaio inox satinato AISI 304.

White resin soap dispenser with satin stainless steel AISI 304 wall support.



H	P	Ø	art.
22	14,2	8	JUST14

Porta carta o porta salviette a parete, dx o sx reversibile, in acciaio inox satinato AISI 304.

Satin stainless steel AISI 304 right or left wall mount paper roll holder.



H	P	L	art.
3	8	14	JUST8

Appendi abiti a parete in acciaio inox satinato AISI 304.

Satin stainless steel AISI 304 clothes hook.



H	P	L	art.
3	8	1,5	JUST7

Porta salviette a parete in acciaio inox satinato AISI 304.

Satin stainless steel AISI 304 wall mount towel rack.

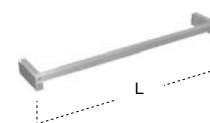

H	P	L	art.
3	8	45	JUST9
		60	JUST19

Piantana porta carta, porta salviette doppio in acciaio inox satinato AISI 304 con porta scopino in resina bianca.

Freestanding satin stainless steel AISI 304 double paper roll or towel rack with white resin toilet brush and holder.



H	P	L	art.
60	21,5	33	JUST106

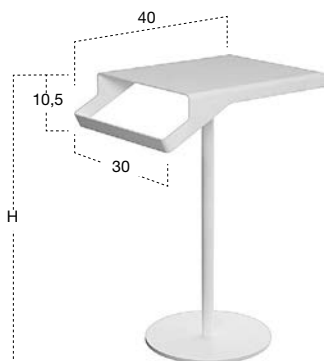

H	P	L	art.
65	40	30	GIN01
75	40	30	GIN02

Tavolino porta oggetti con porta salviette, in acciaio inox AISI 304 verniciato bianco, nero opaco o colorato gofrato come da nostra cartella colori laccati.

Stainless steel AISI 304 table with towel rail lacquered matt white, black or embossed as per our colour chart.



COMPLEMENTI E ACCESSORI
FURNISHINGS - ACCESSORIES

H	Ø	art.
68,5	36	LINO1
78,5	36	LINO2

Tavolino porta oggetti con piano in Cristalplant e piedistallo in acciaio inox AISI 304 verniciato bianco o colorato goffrato come da nostra cartella colori laccati.

Table for objects with a Cristalplant surface and stainless steel AISI 304 base lacquered matt white or embossed as per our colour chart.

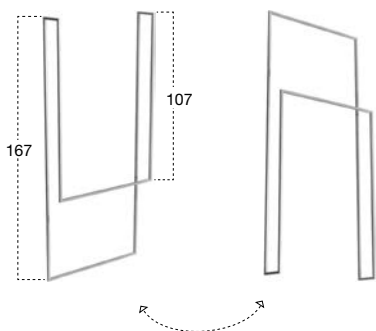

H	P	L	art.
167	15	72	TANDEM-UP

Porta salviette doppio da terra o da soffitto con struttura tubolare 15 x 15 mm in acciaio inox satinato AISI 304.

Double towel rack freestanding or hanging with 15 x 15 mm satin stainless steel AISI 304 tubular structure.



H	P	L	art.
80	15	54	TANDEMSA
80	15	54	TANDEMLU

Porta salviette doppio da terra con struttura tubolare 15 x 15 mm in acciaio inox AISI 304 satinato o lucido.

Double freestanding towel rack with 15 x 15 mm satin or polished stainless steel AISI 304 tubular structure.

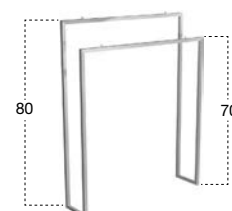



H	L	art.
8,3	2,5	BILLO

Appendi abiti singolo in acciaio inox satinato AISI 304 per vetri box doccia.

Single clothes hook in satin stainless steel AISI 304 suitable for shower enclosures.



H	P	L	art.
4,6	32	36	TAO

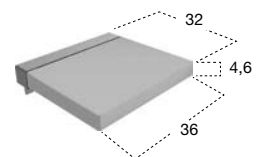

Seggetta reclinabile con fissaggio a parete in acciaio inox lucido AISI 304 e seduta di colore bianco in poliuretano morbido.

Reclinable white soft polyurethane seat with polished stainless steel AISI 304 wall supports.