



Underscore® Rectangle

60" drop-in bath

K-1137

Features

- Generous 6-foot length provides spacious bathing for up to two people.
- Molded lumbar support offers extra comfort while bathing.
- Slotted overflow allows for deep soaking.
- Center drain.

Material

- Acrylic.

Installation

- Undermount.
- Drop-in or undermount.

Required Products/Accessories

K-7271 Brass Slotted Overflow Bath Drain

or

K-7272 PVC Slotted Overflow Bath Drain

Recommended Products/Accessories

K-592 Under-Mount Installation Kit

K-24916 Wireless Music Kit

K-1601 Bath/Whirlpool Footstop

K-23726 Drain treatment

K-23732 Tub & shower cleaner



Codes/Standards

CSA B45.5/IAPMO Z124

ASTM E162









ASTM E662

KOHLER® Plastic Baths and Receptors Lifetime Limited Warranty

See website for detailed warranty information.

Available Colors/Finishes

Color tiles intended for reference only.

Color	Code	Description
	0	White
	96	Biscuit
	47	Almond
	NY	Dune
	95	Ice™ Grey
	G9	Sandbar
	K4	Cashmere
	58	Thunder™ Grey
	7	Black Black™

1-800-4KOHLER (1-800-456-4537)

Kohler Co. reserves the right to make revisions without notice to product specifications.

For the most current Specification Sheet, go to www.kohler.com.

3-12-2020 07:11 - US/CA

THE BOLD LOOK
OF **KOHLER**®

No change in measurements if connected with drain illustrated. (K-7272)

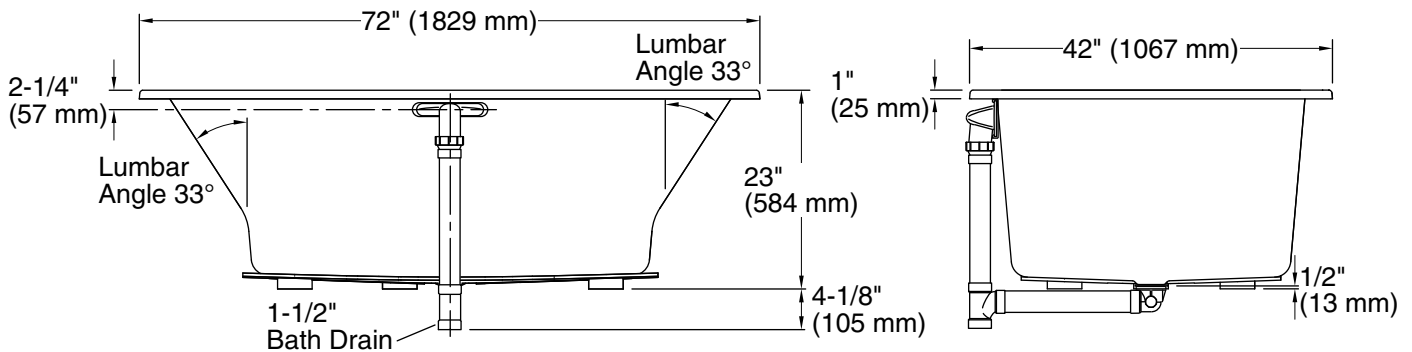
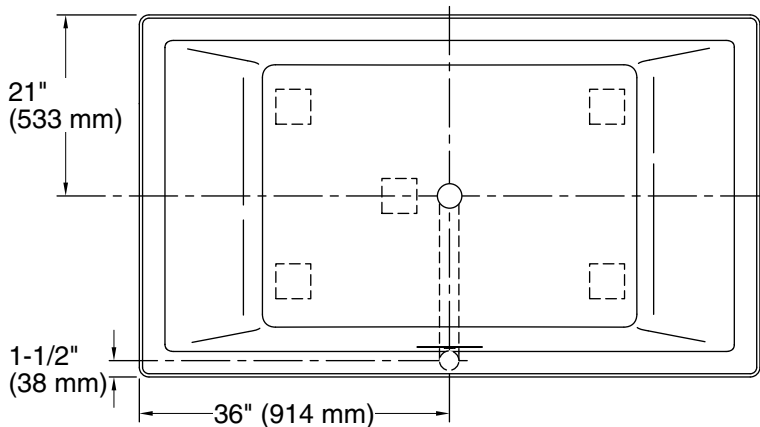

Technical Information

All product dimensions are nominal.

Installation:	Drop-in, Under-mount
Drain location:	Center
Basin area, bottom:	45-3/4" x 32" (1162 mm x 813 mm)
Basin area, top:	66" x 36" (1676 mm x 914 mm)
Weight:	85 lbs (38.6 kg)
Minimum floor load:	60 lbs/ft ² (292.9 kg/m ²)
Water depth:	19" (483 mm)
Water capacity:	139 gal (526.2 L)
Cutout:	Drop-in, 70-1/2" x 40-1/2" (1791 mm x 1029 mm)
Minimum flat for door:	2-9/16" (66 mm)

Notes

Measure your actual product for rough-in details.

Install this product according to the installation instructions.

The hot water supply should be 70% of the capacity of the bath or greater. Installations will vary.

Kit is required for under-mount installations (sold separately).