

# DIMEZZO - FRAMEZZO

design AL Studio

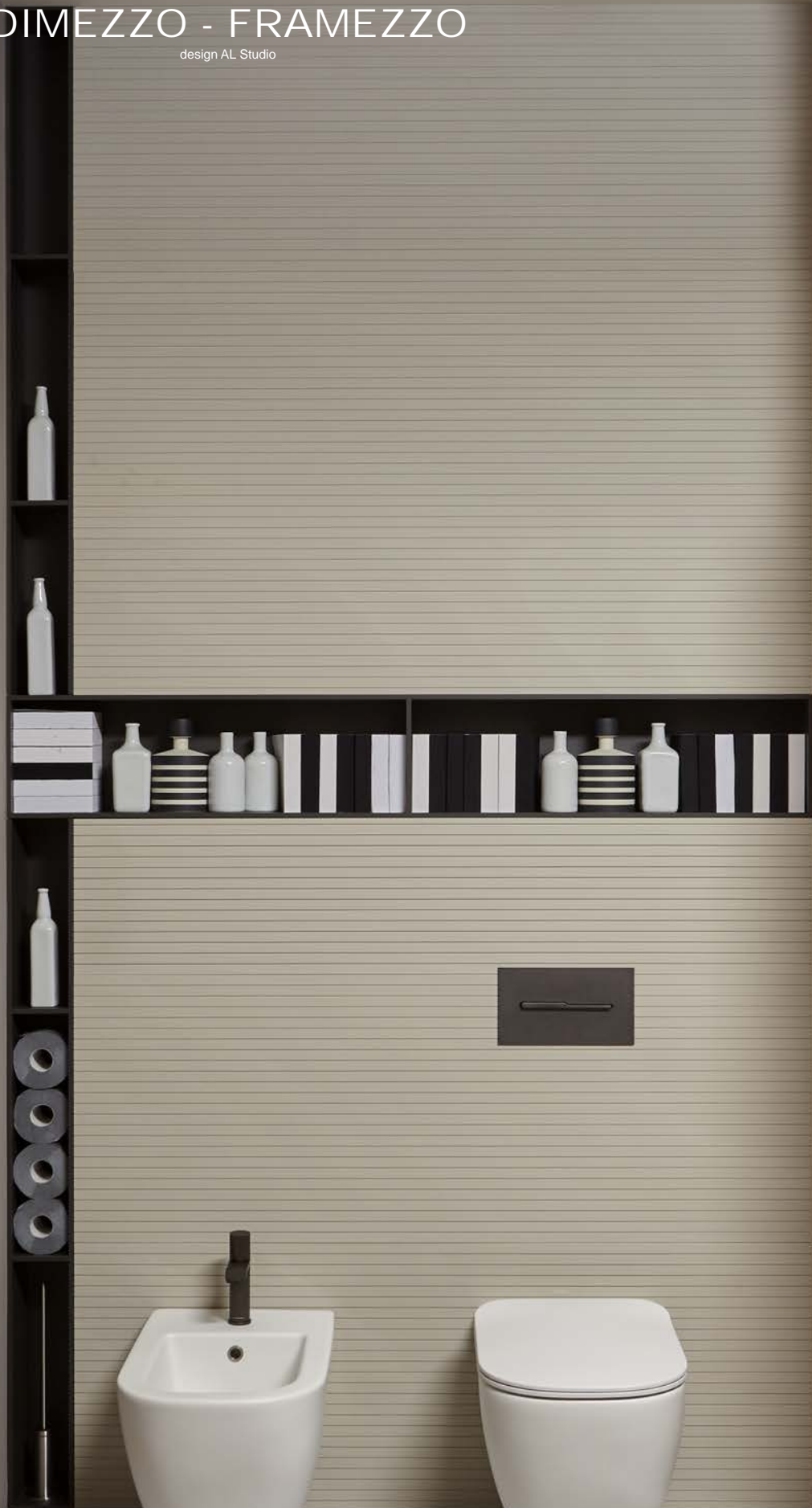

# antoniolupi

MADE IN ITALY

## Art. DIMEZZO

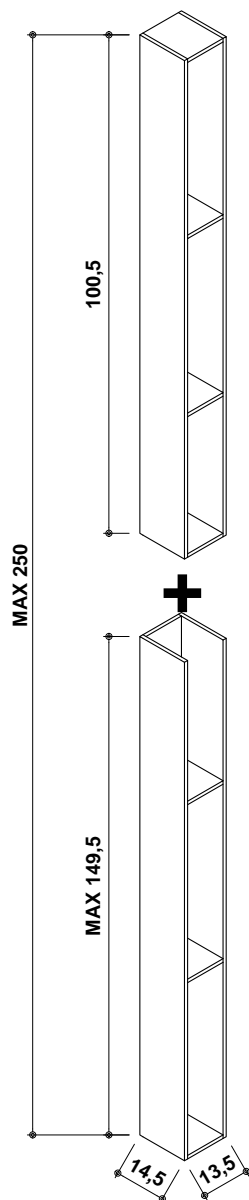

## Art. FRAMEZZO

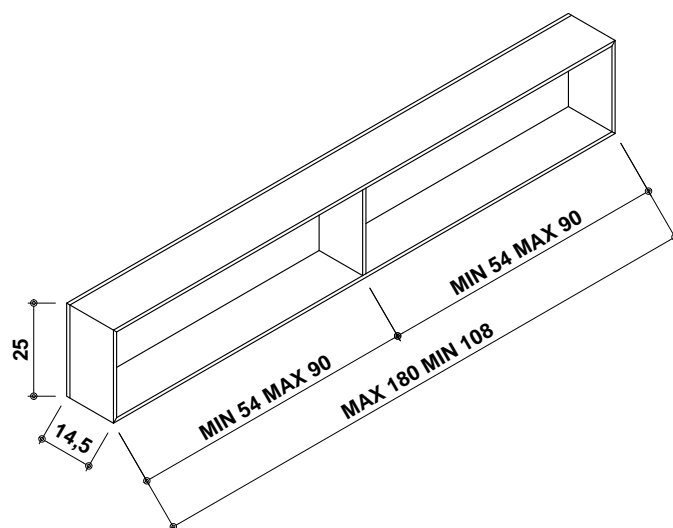

Art. DIMEZZO + FRAMEZZO

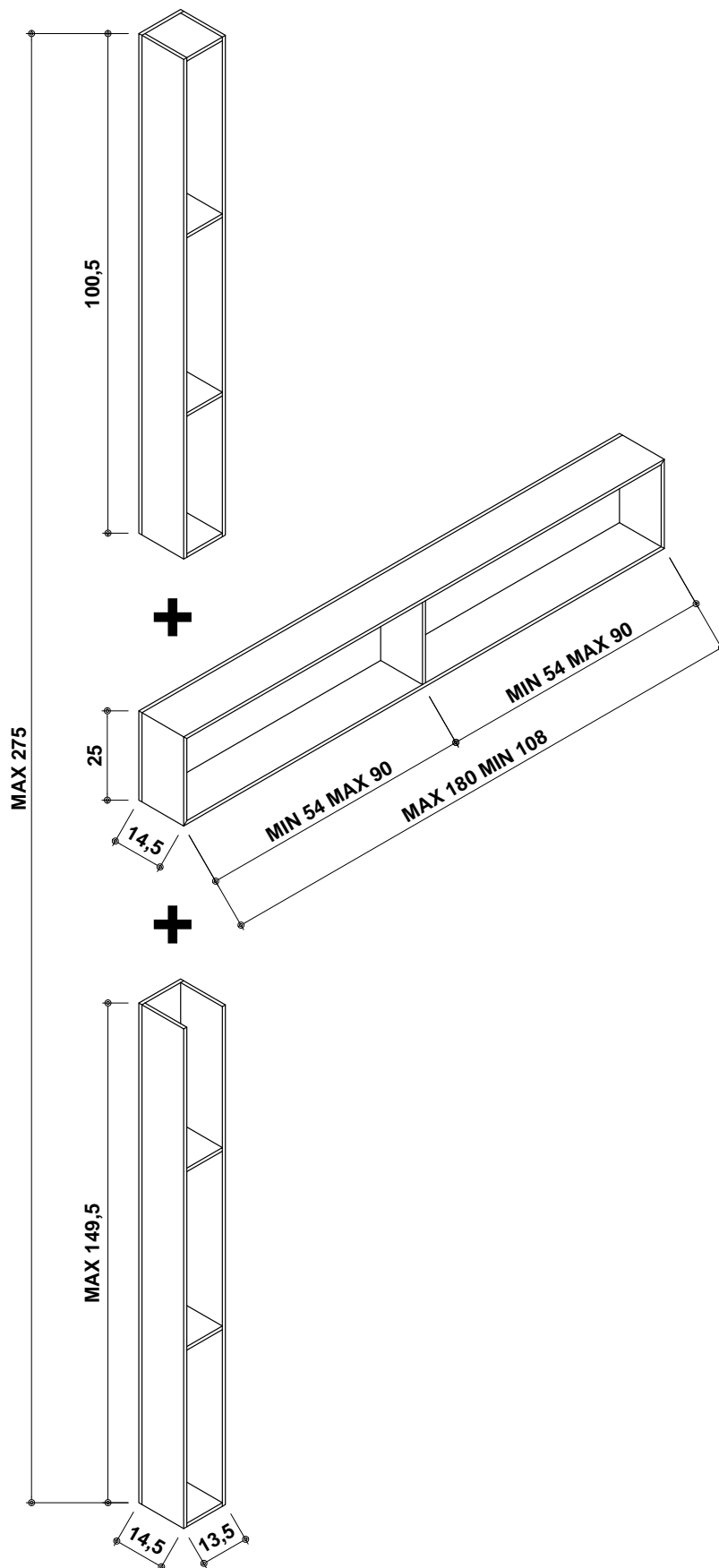

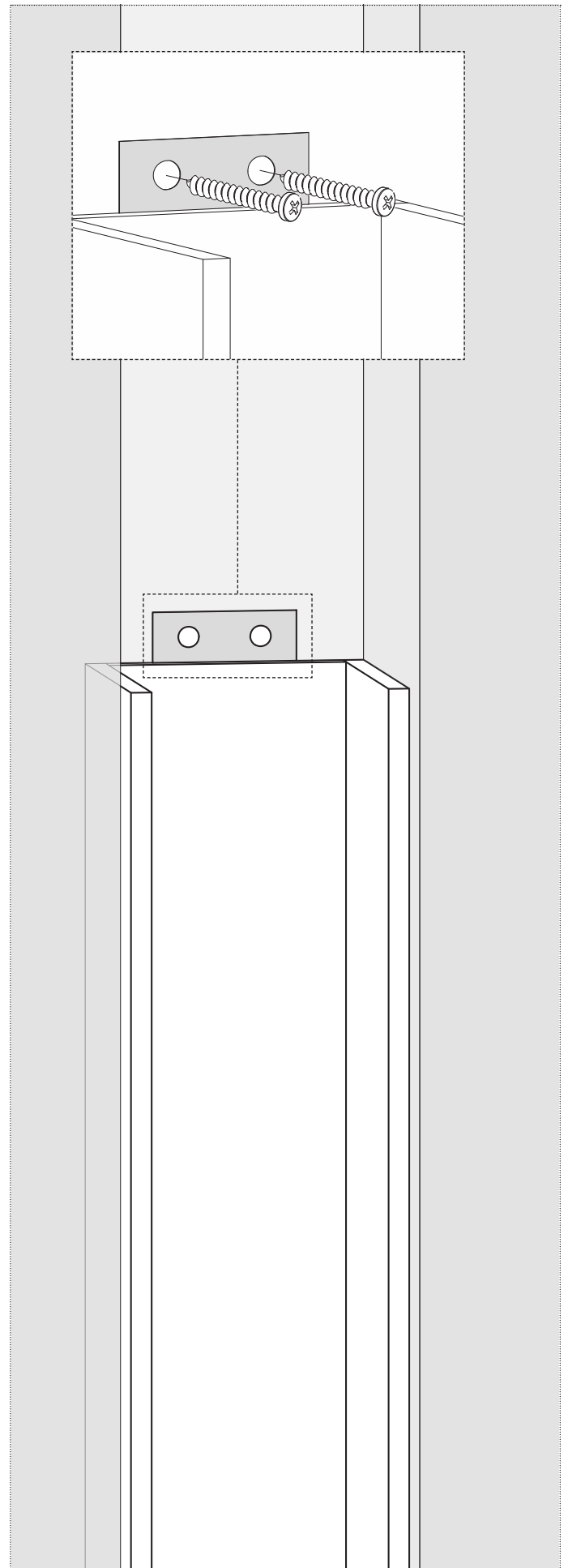
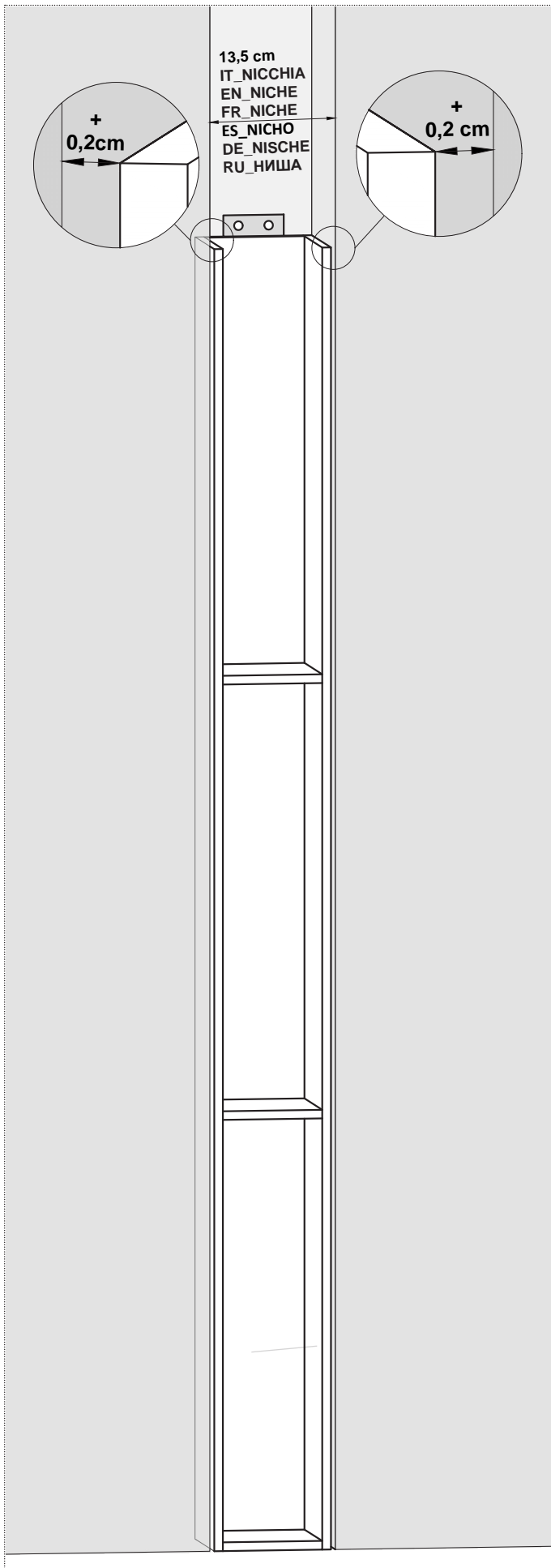

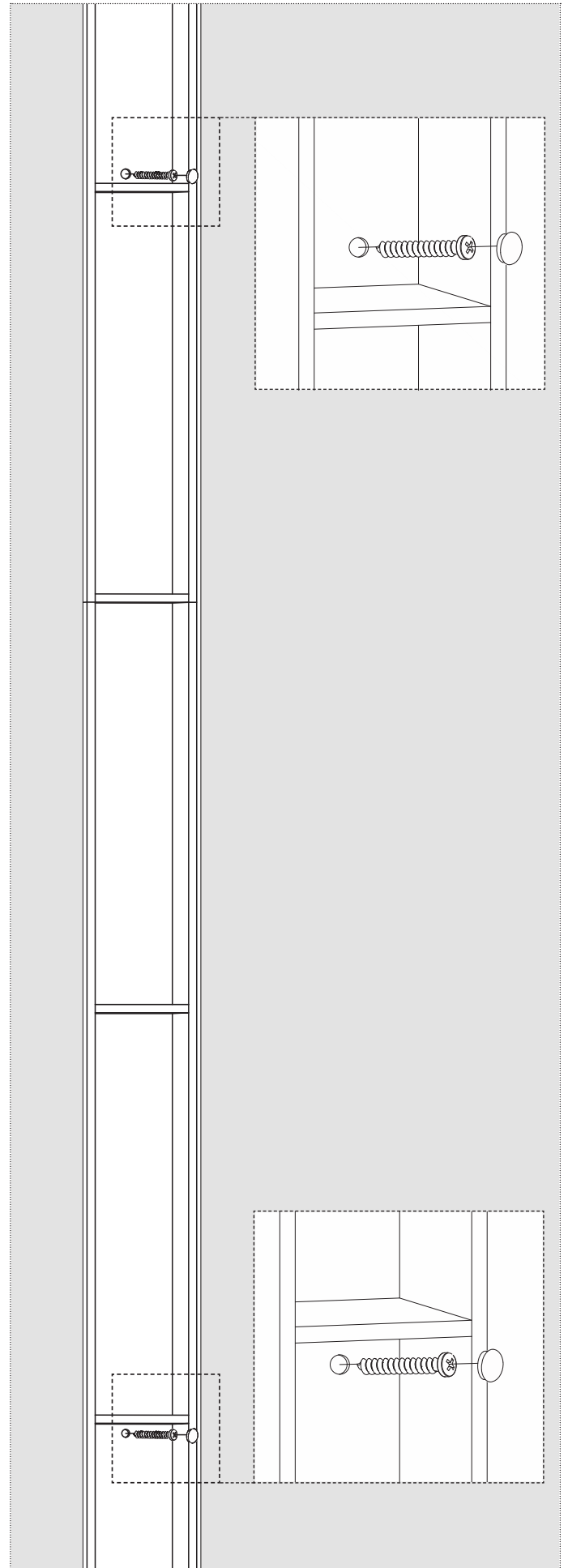
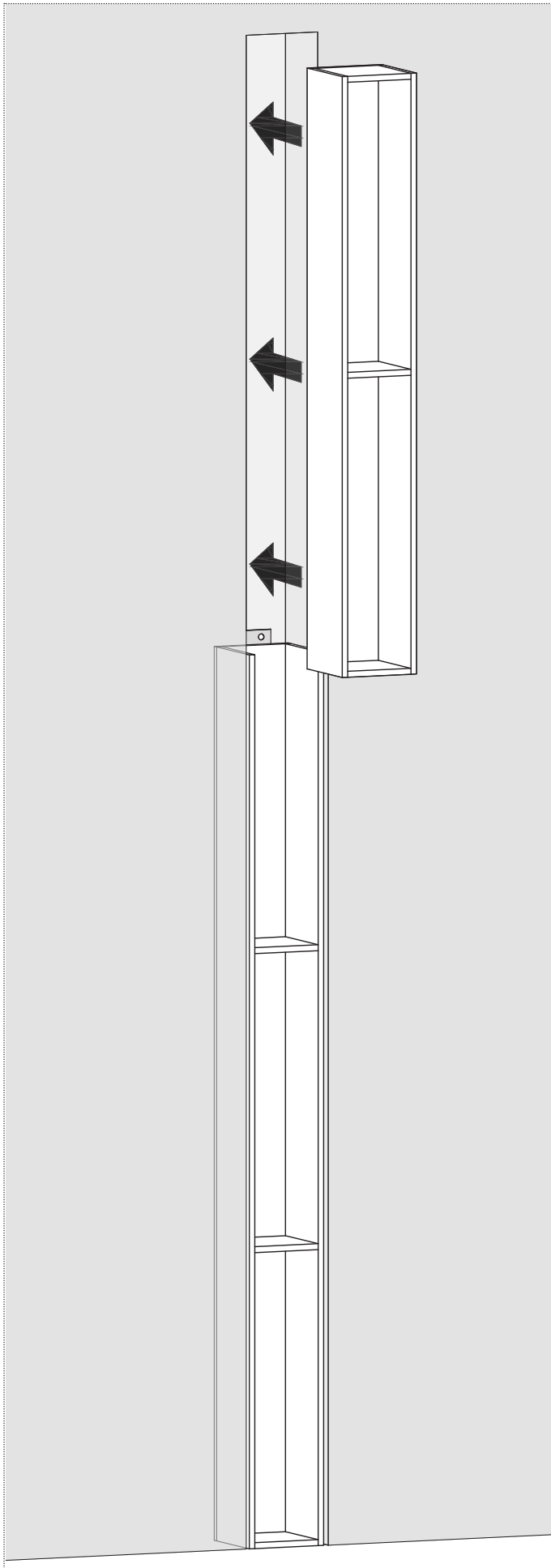

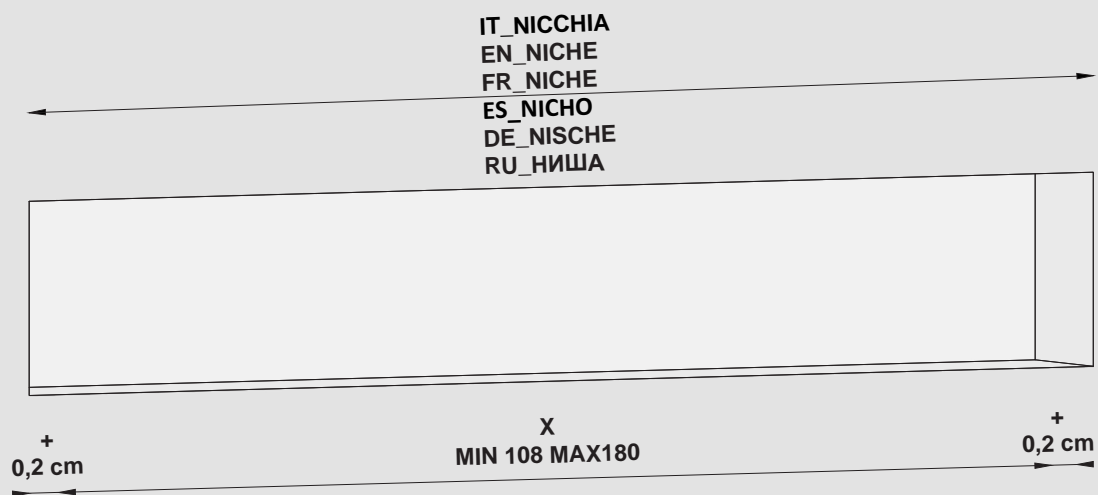

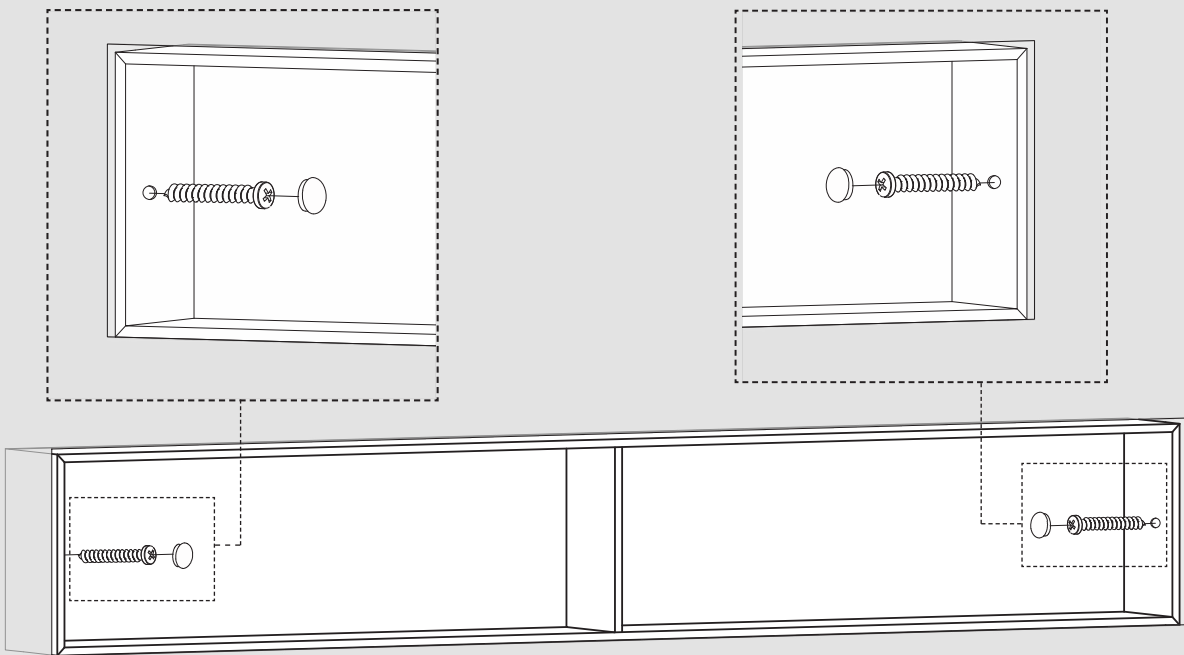

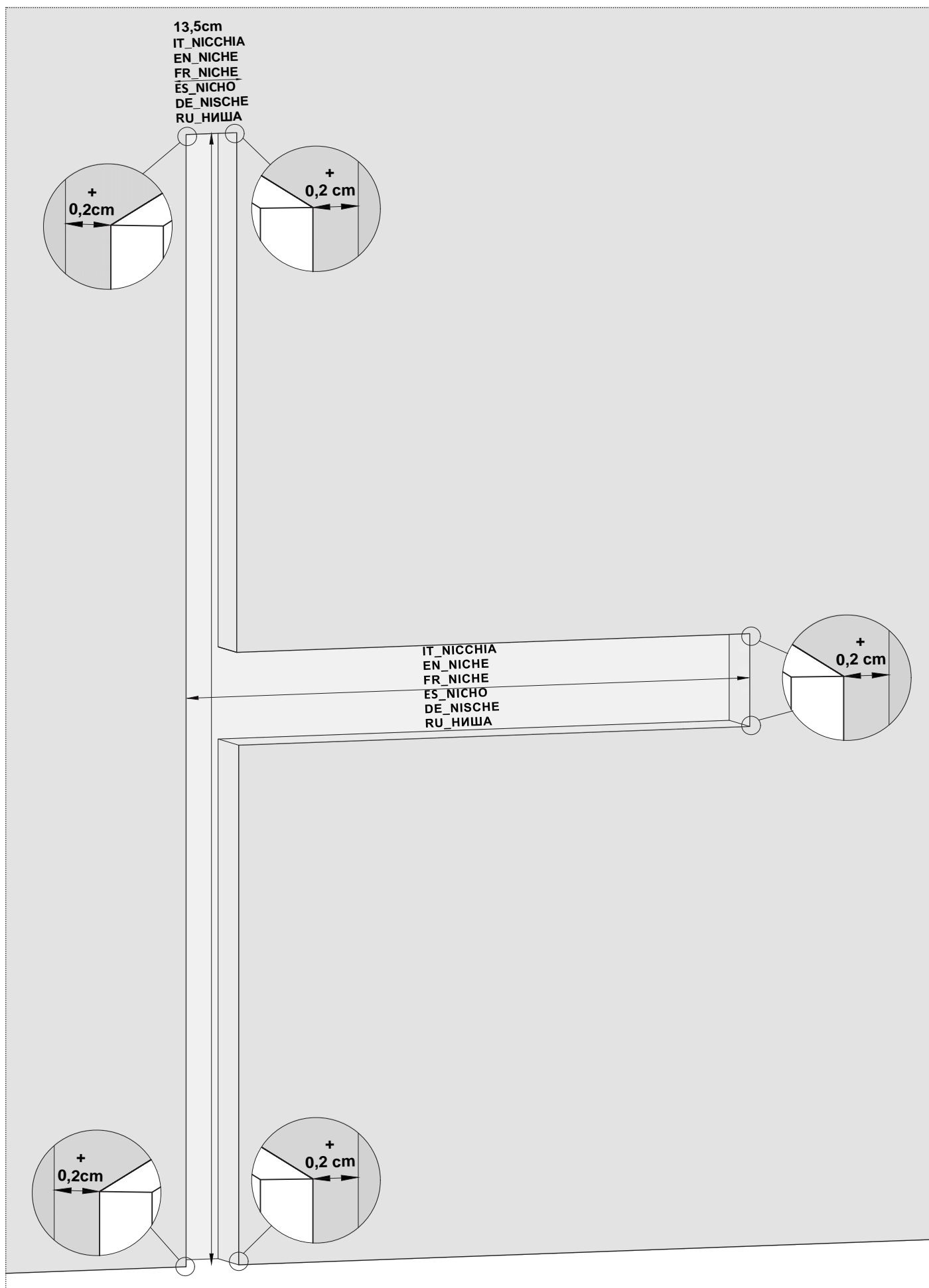



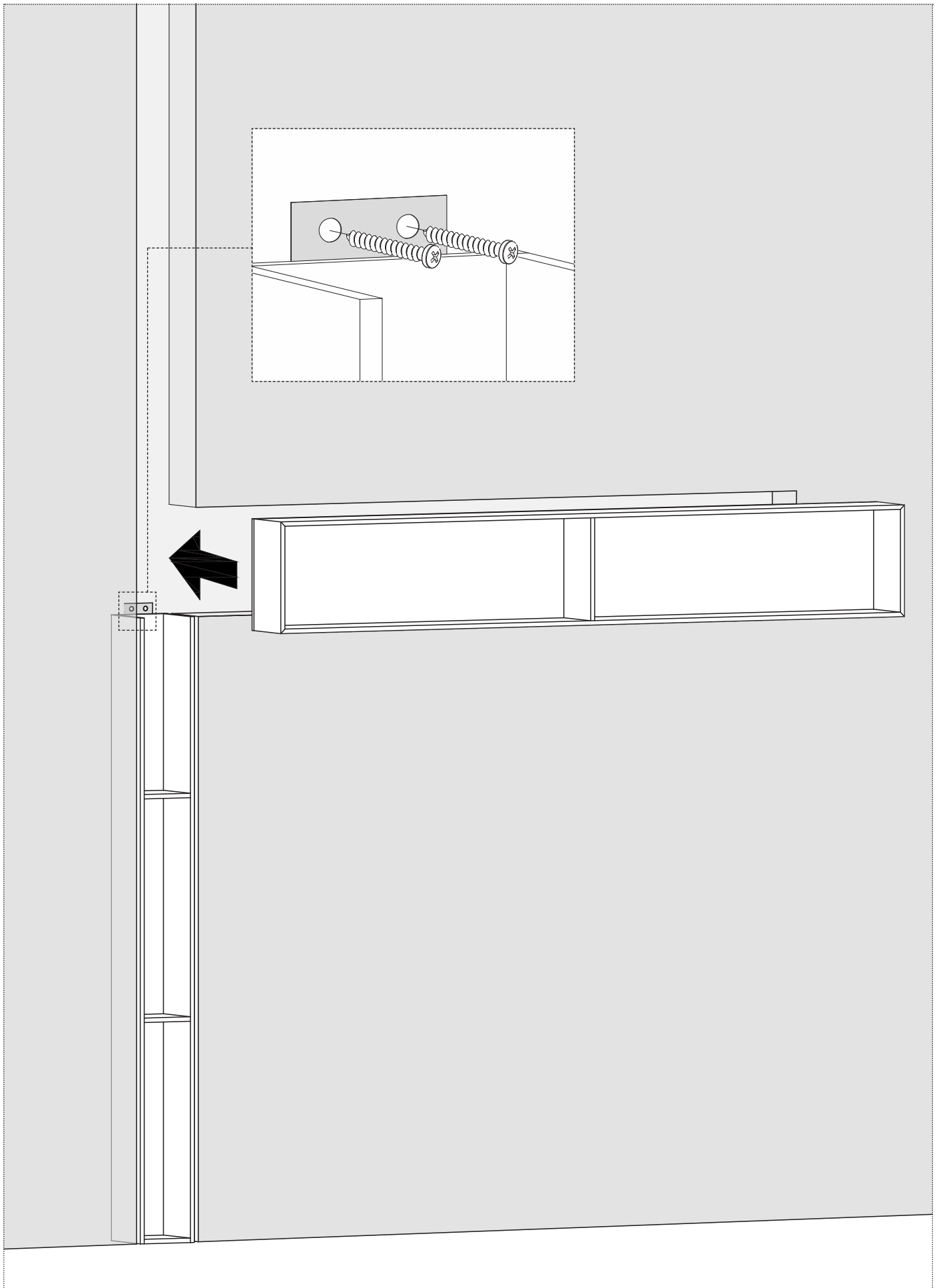

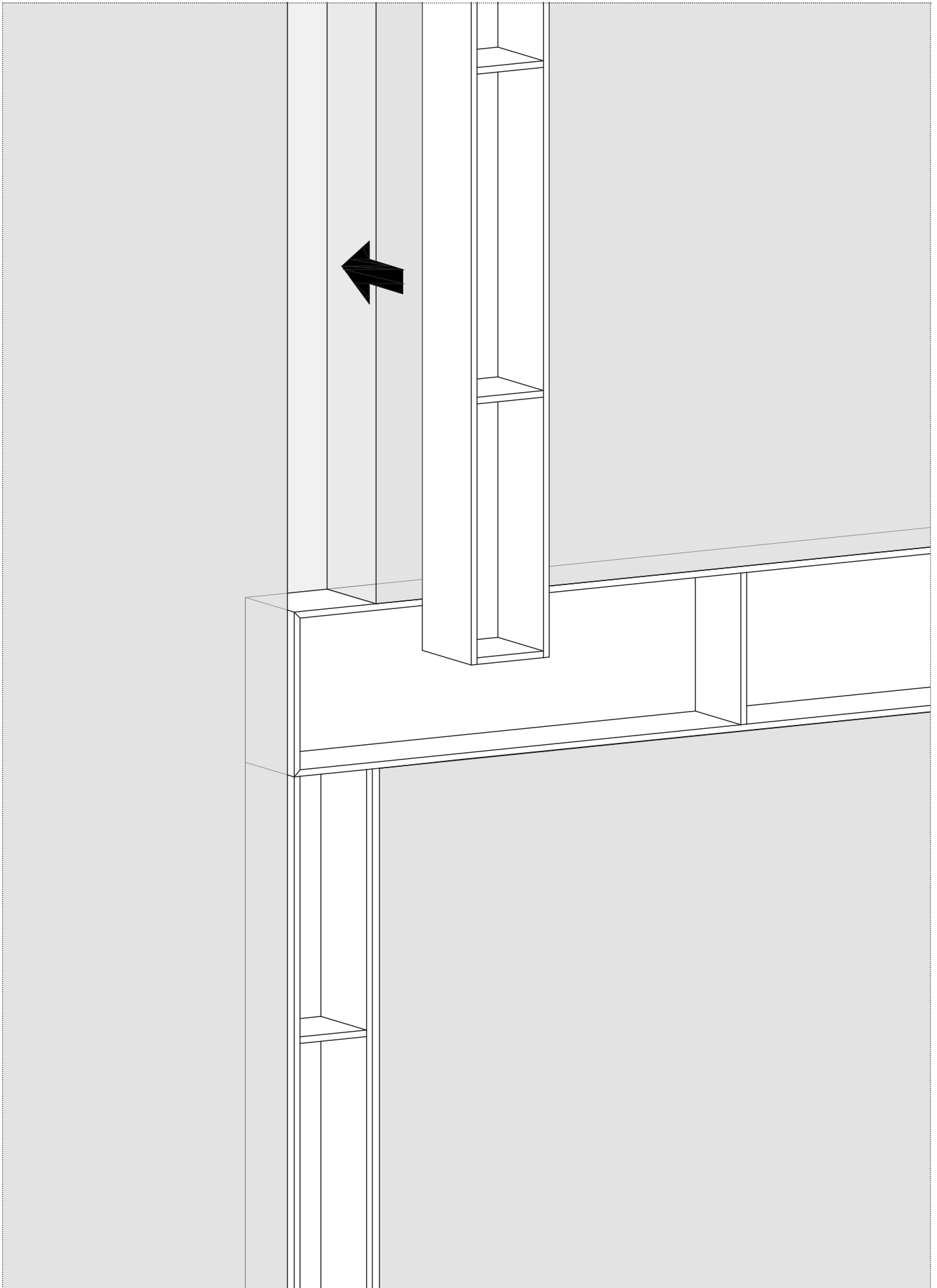

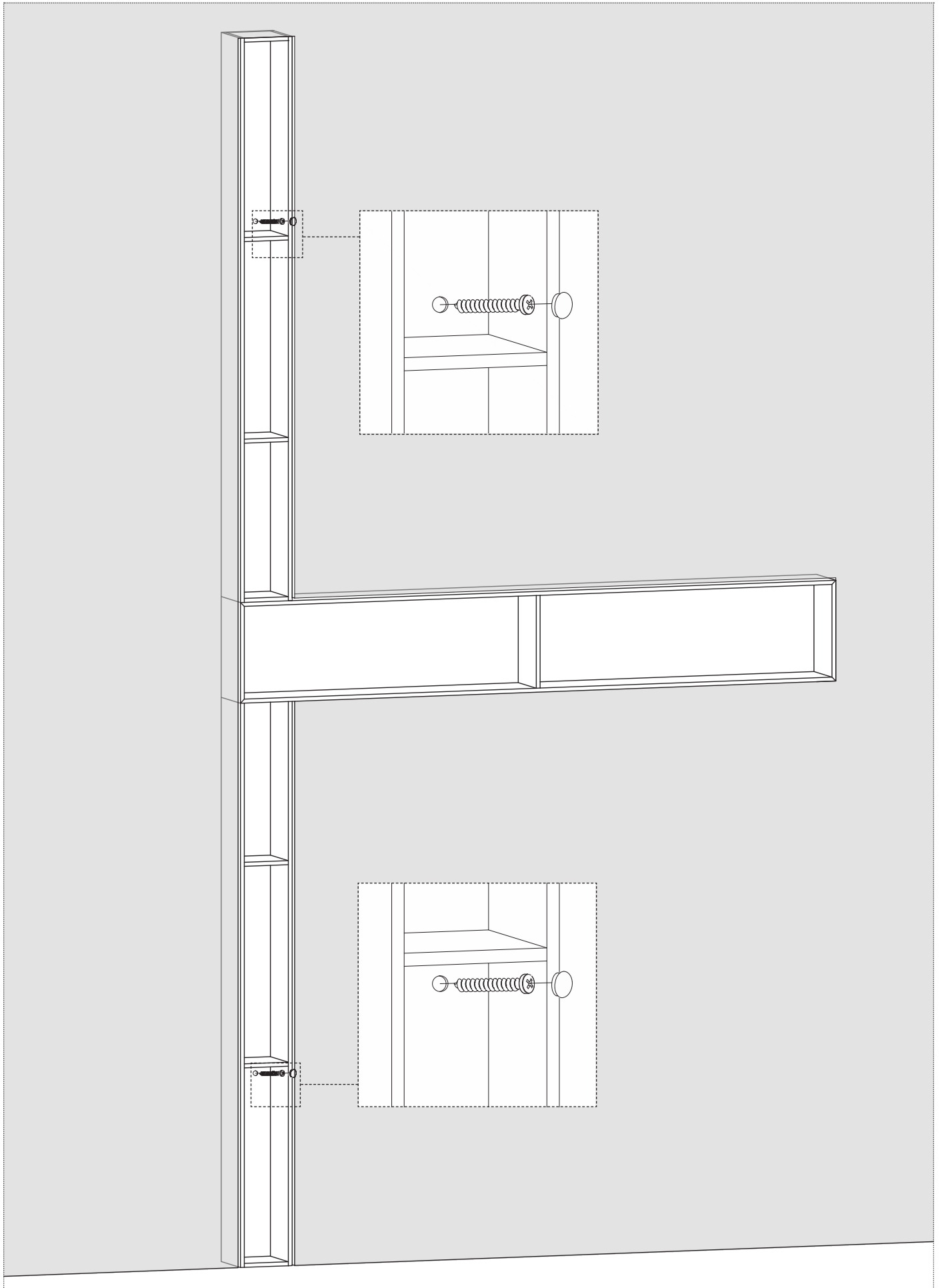

**antoniolupi**

**73**

VIA MAZZINI

**75**

Antonio Lupi Design S.p.A.  
via Mazzini 73/75 - 50050 Stabbia  
Cerreto Guidi (Firenze) - Italy  
T +39 0571 586881\_95651  
F +39 0571 586885  
[www.antoniolupi.it](http://www.antoniolupi.it)  
[lupi@antoniolupi.it](mailto:lupi@antoniolupi.it)