

**PIATTO DOCCIA A MISURA  
IN CORIAN\_FILOPAVIMENTO**

**LUNGHEZZA : AL CENTIMENTO-max 300**

**LARGHEZZA : AL CENTIMENTO-max 150**

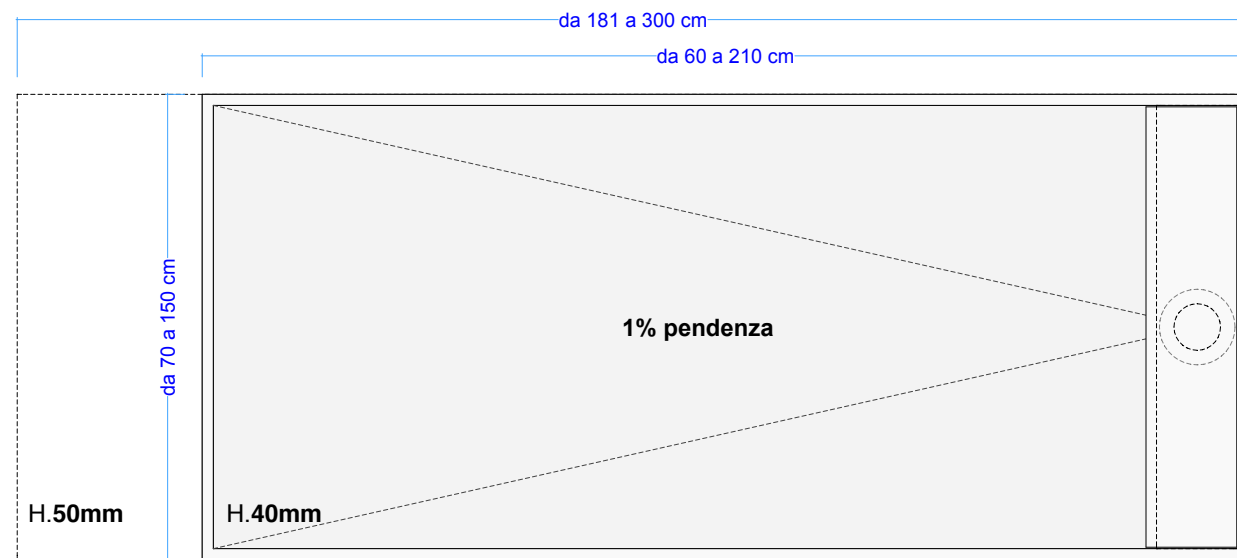

- **piatto doccia in CORIAN strutturato**  
thermal-formed basin in pst to be panelled
- **su misura al centimetro / max 210x115**  
made to measure in centimetre steps / max 210x115
- **in appoggio**  
floor standing
- **piletta ribassata h. 80 mm da 35 lt/min**  
lowered waste h. 80 mm flow rate 35 lt/min

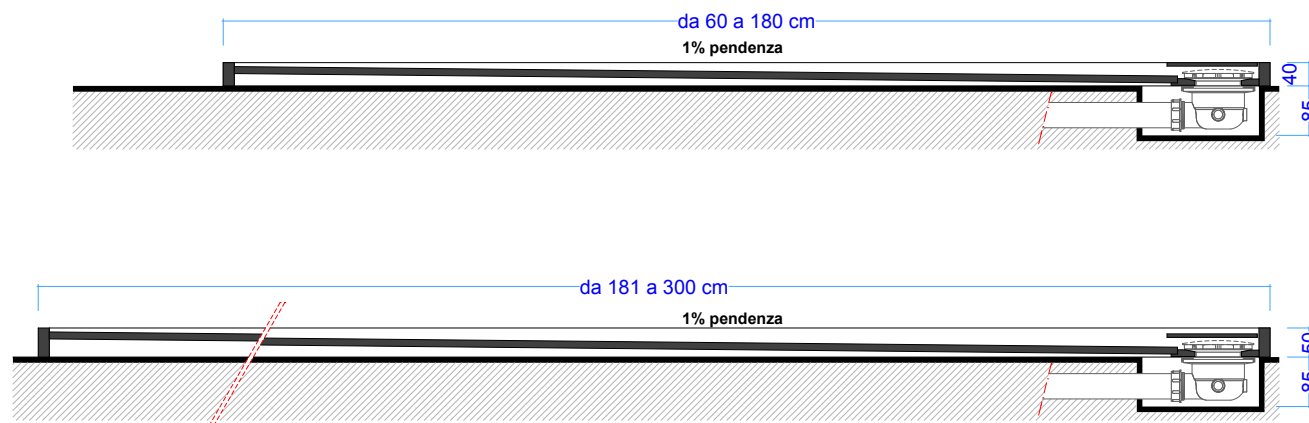

H.40mm

H.50mm

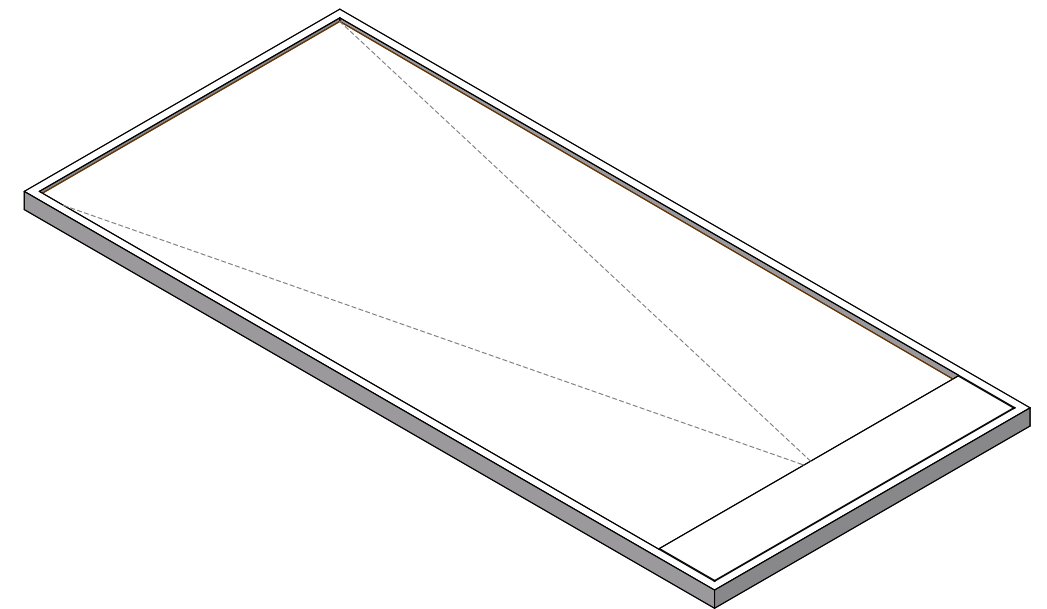

SLIM+LINEA\_BOX

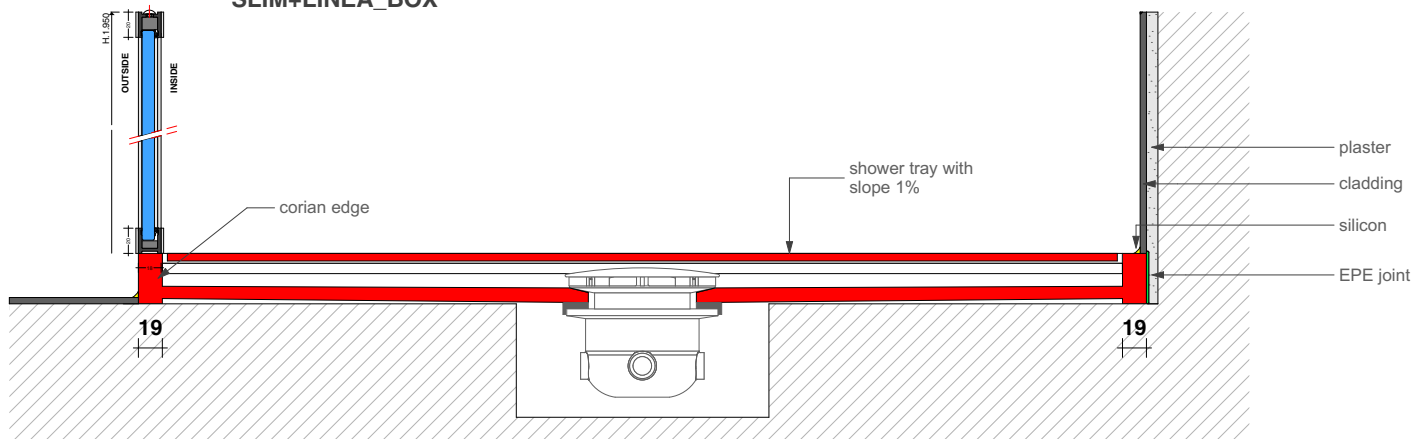

SLIM+SLIDE\_BOX

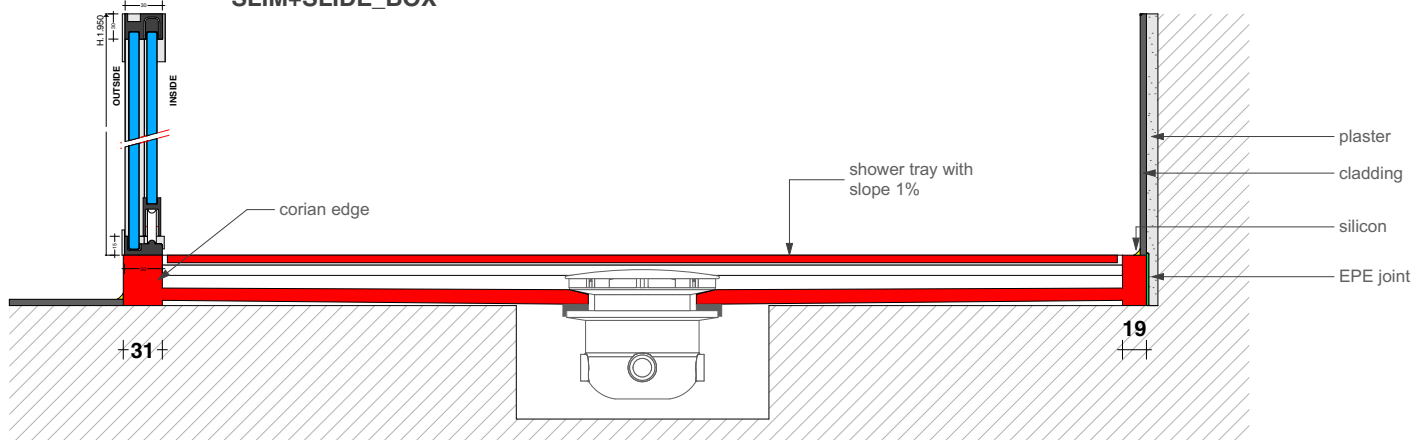

SLIM- piatto doccia a filopavimento  
*SLIM\_Floorflush shower tray*

installazione  
installation

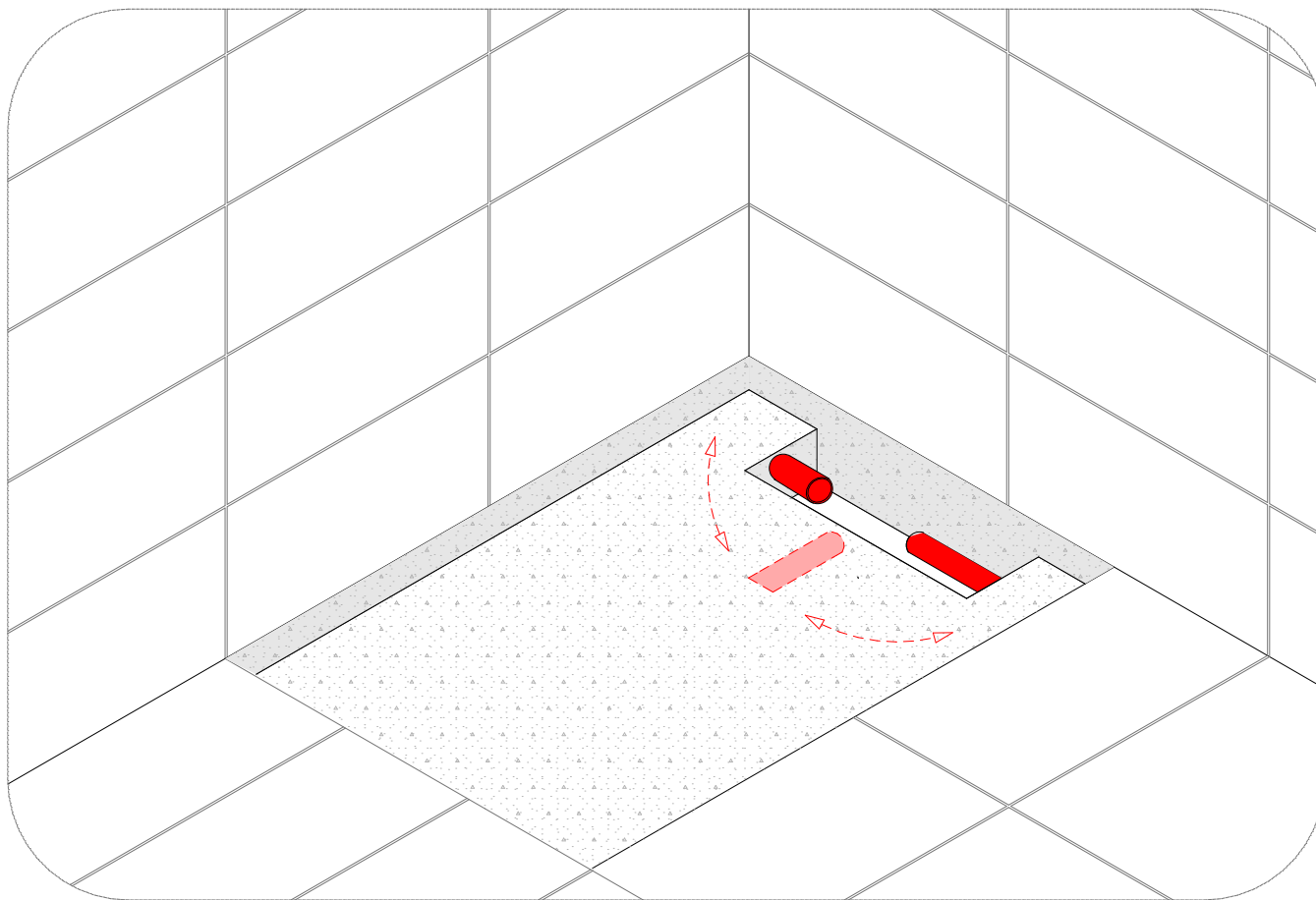

Predisporre tubo di scarico Ø 50 mm

*Foresee drain Ø 50 mm*

SLIM- piatto doccia a filopavimento  
*SLIM\_Floorflush shower tray*

installazione  
installation

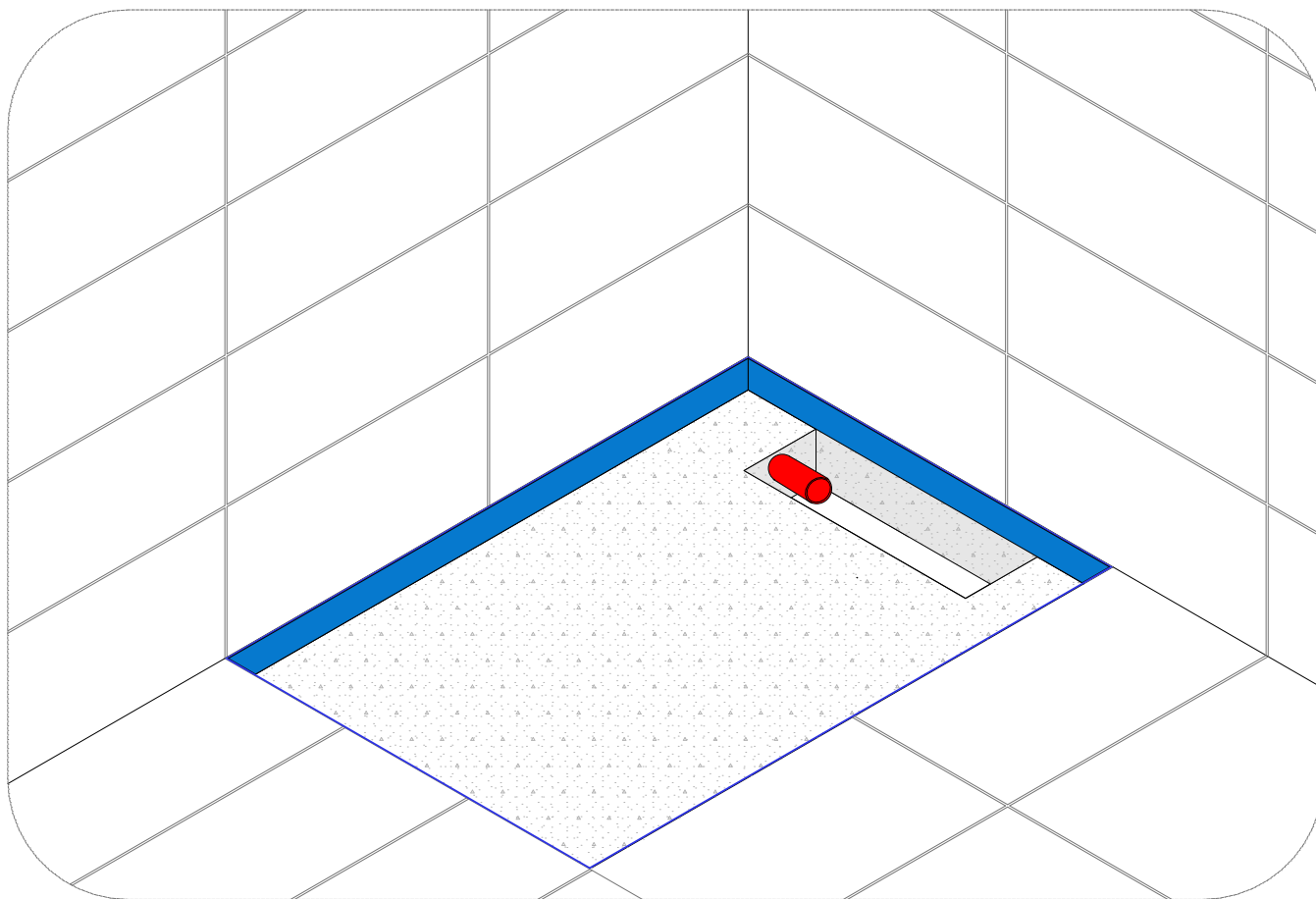

Applicare fascia in PE espanso perimetralmente

*Apply an expanded PE band on the 4 sides*

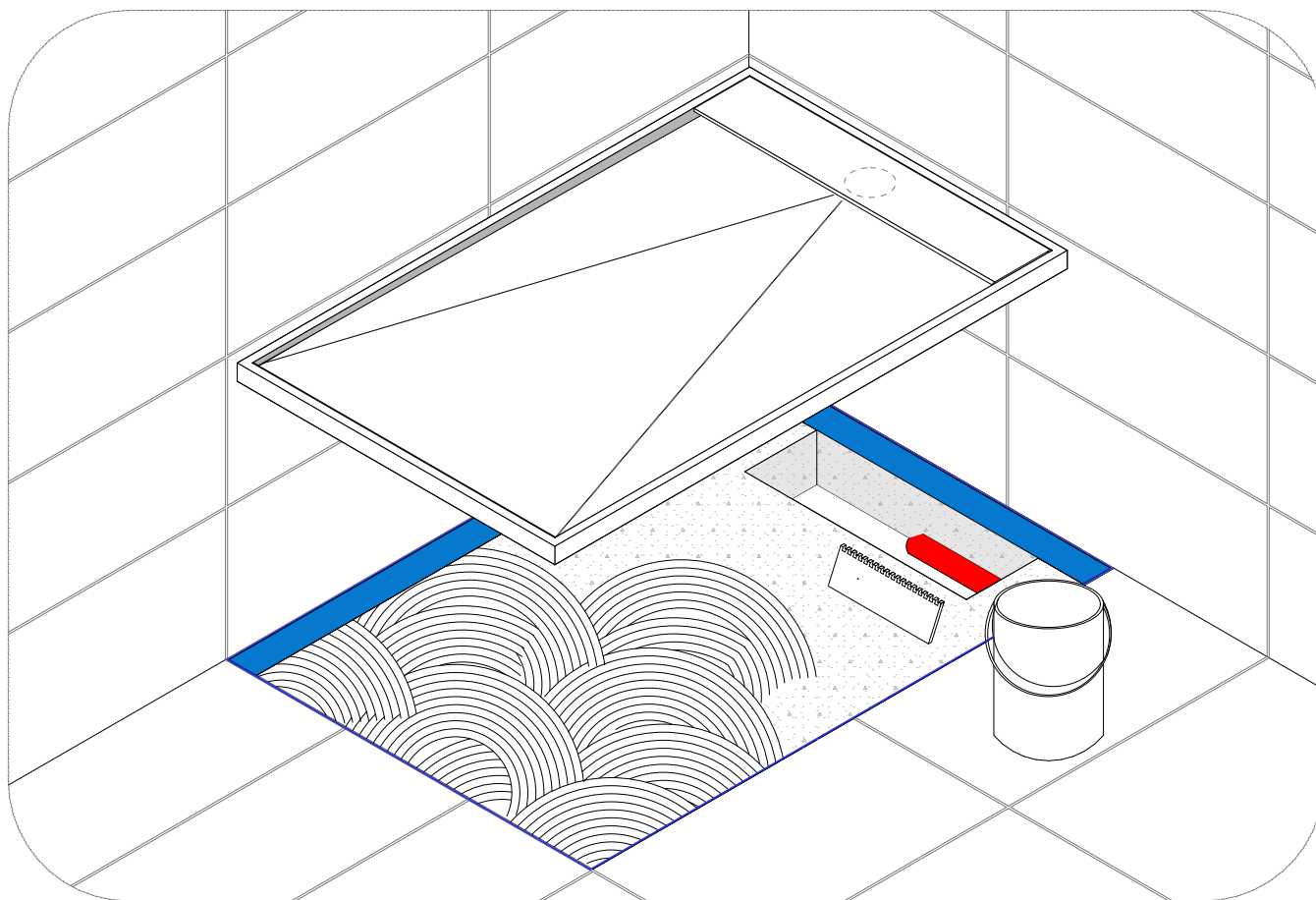

L'incollaggio a pavimento va effettuato su tutta la superficie con collante MAPEI KERALASTIC o con altro collante con uguali caratteristiche tecniche

*Apply some MAPEI KERALASTIC glue, or any other glue having the same technical features, on the whole surface of the tray to fix it to the floor*

**SLIM- piatto doccia a filopavimento**  
**SLIM\_Floorflush shower tray**

installazione  
installation

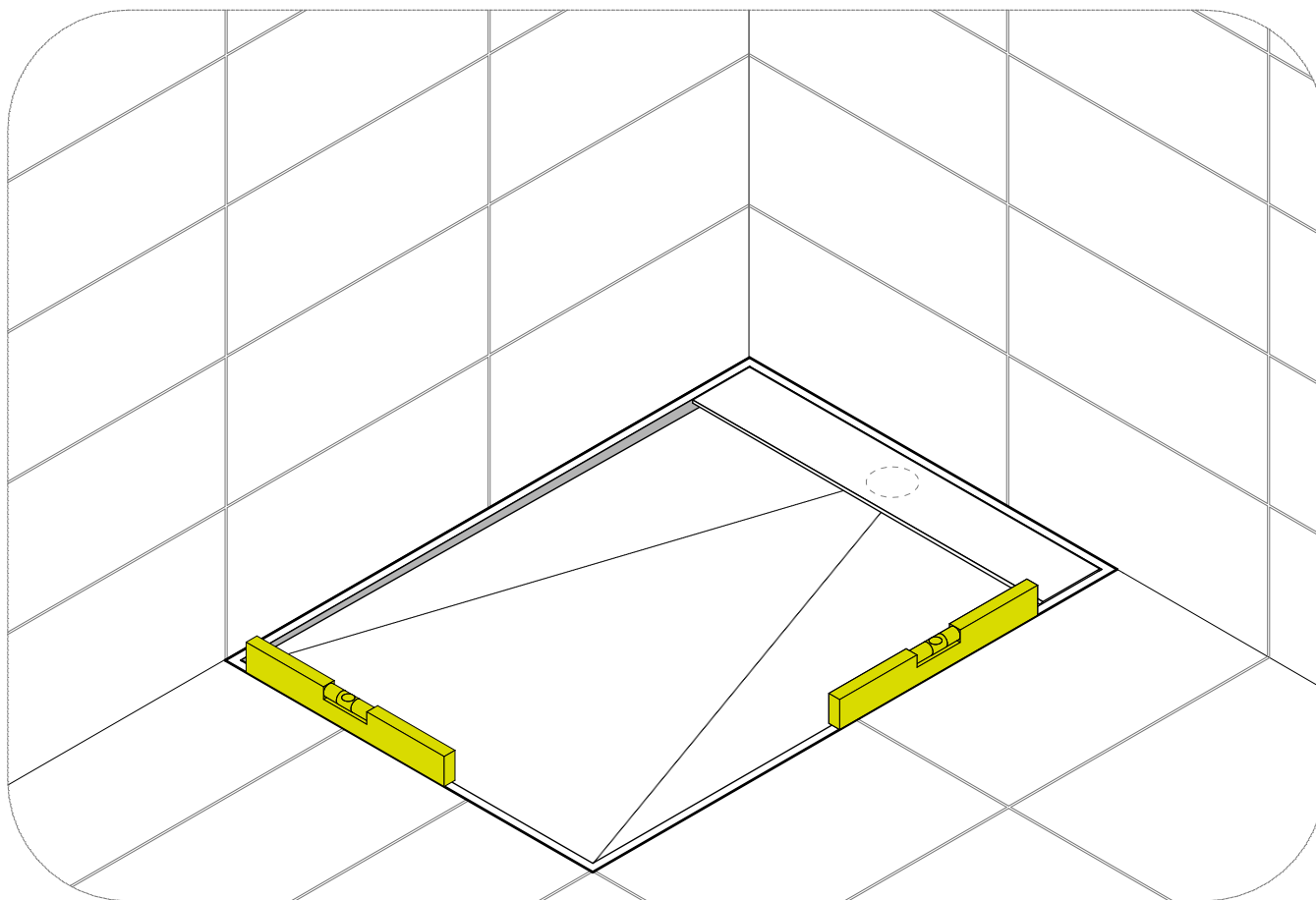

Mettere a livello il piatto doccia

*Level the shower tray*

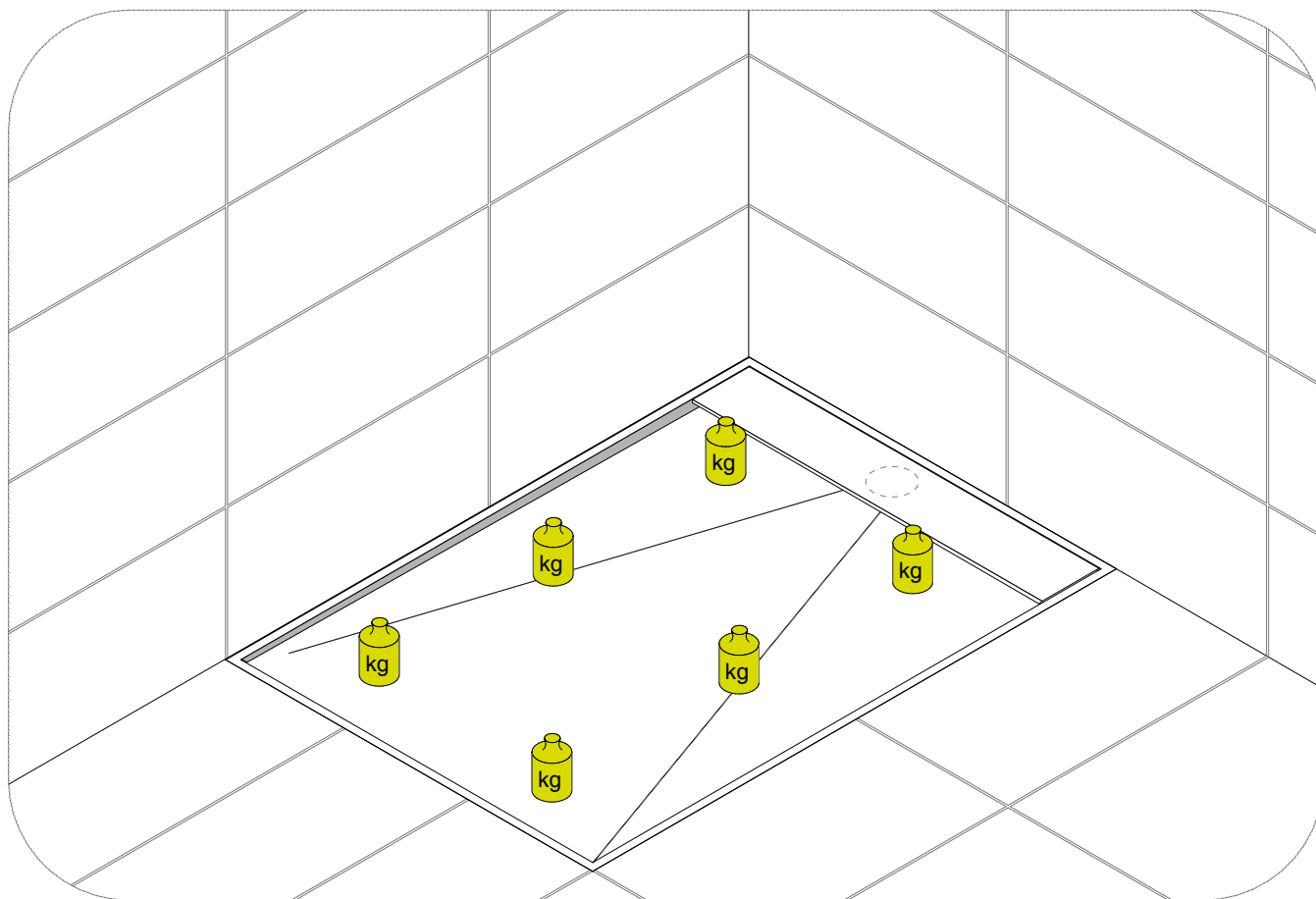

Distribuire uniformemente dei pesi sul piatto doccia per garantire l'incollaggio continuo al massetto.

*Distribute evenly some weights on the shower tray to glue it continuously to the screed.*

**SLIM- piatto doccia in appoggio**  
**SLIM \_Floorstanding shower tray**

installazione  
installation

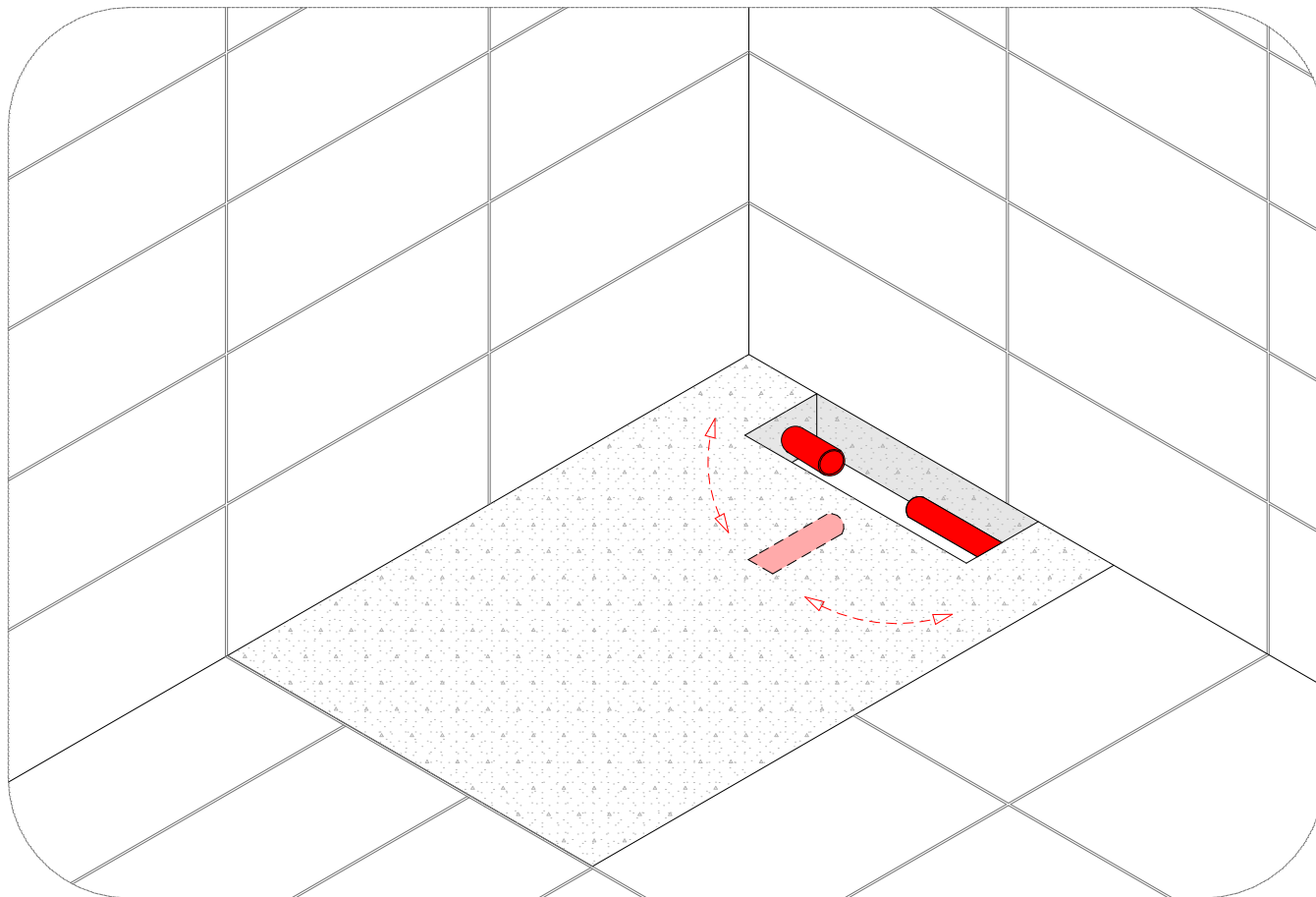

Predisporre tubo di scarico Ø 50 mm

Foresee drain Ø 50 mm



**SLIM- piatto doccia in appoggio**  
**SLIM \_Floorstanding shower tray**

installazione  
installation

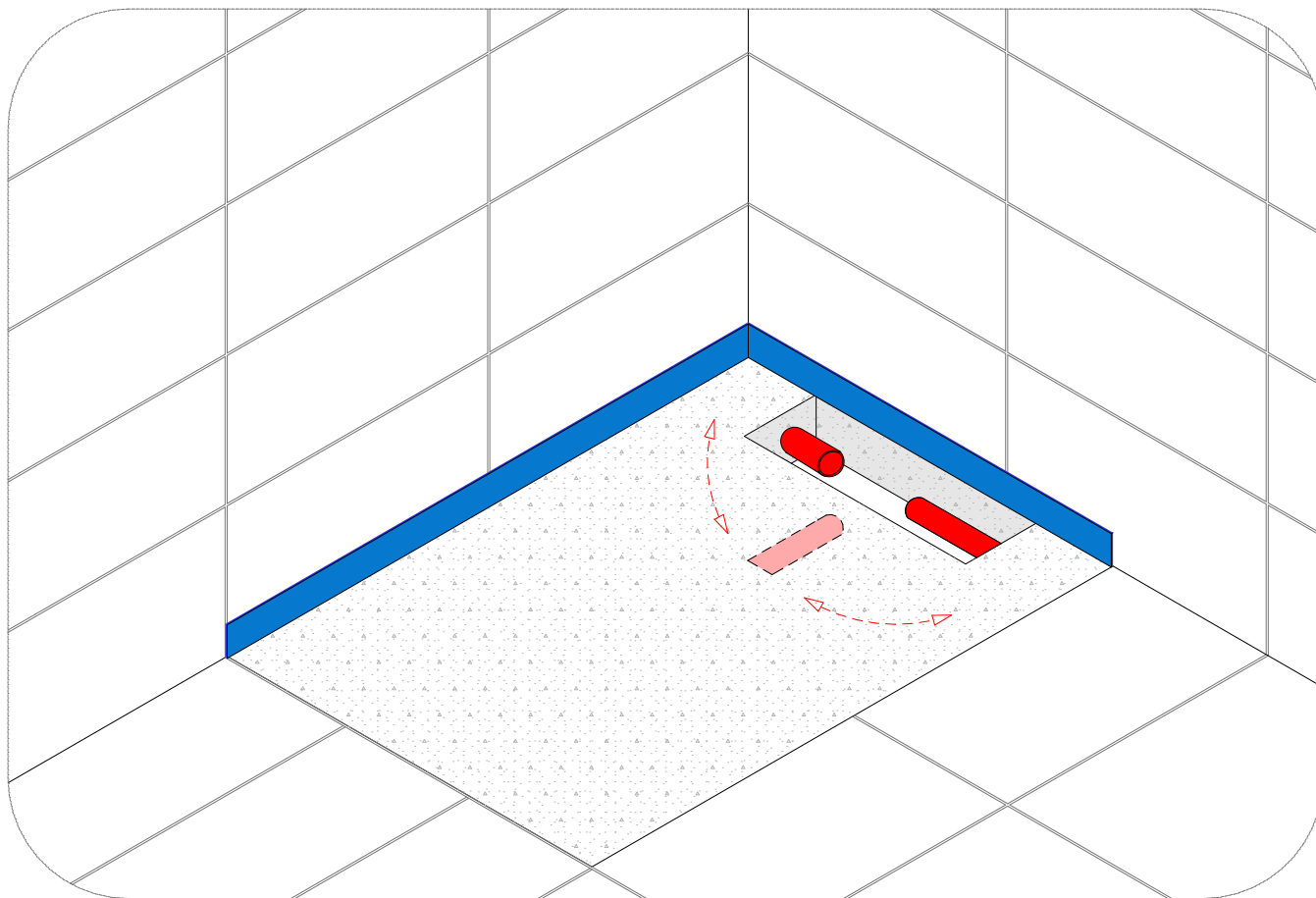

Applicare fascia in PE espanso lungo le pareti a contatto con il piatto doccia.

*Apply an expanded PE band on the walls against the shower tray.*

SLIM- piatto doccia in appoggio  
*SLIM\_Floorstanding shower tray*

installazione  
installation

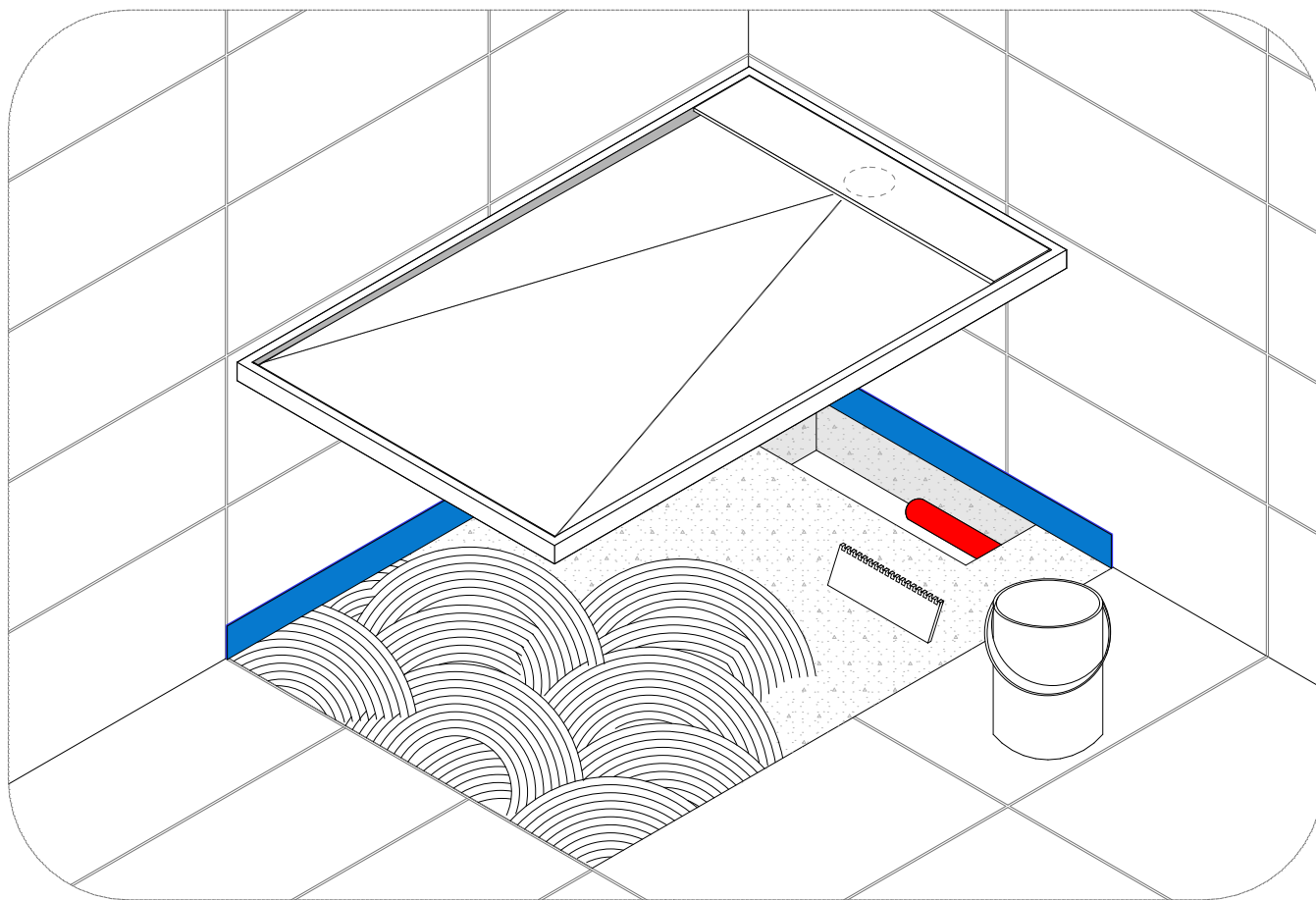

L'incollaggio a pavimento va effettuato su tutta la superficie con collante MAPEI KERALASTIC o con altro collante con uguali caratteristiche tecniche

*Apply some MAPEI KERALASTIC glue, or any other glue having the same technical features, on the whole surface of the tray to fix it to the floor*

**SLIM- piatto doccia in appoggio**  
**SLIM \_Floorstanding shower tray**

installazione  
installation

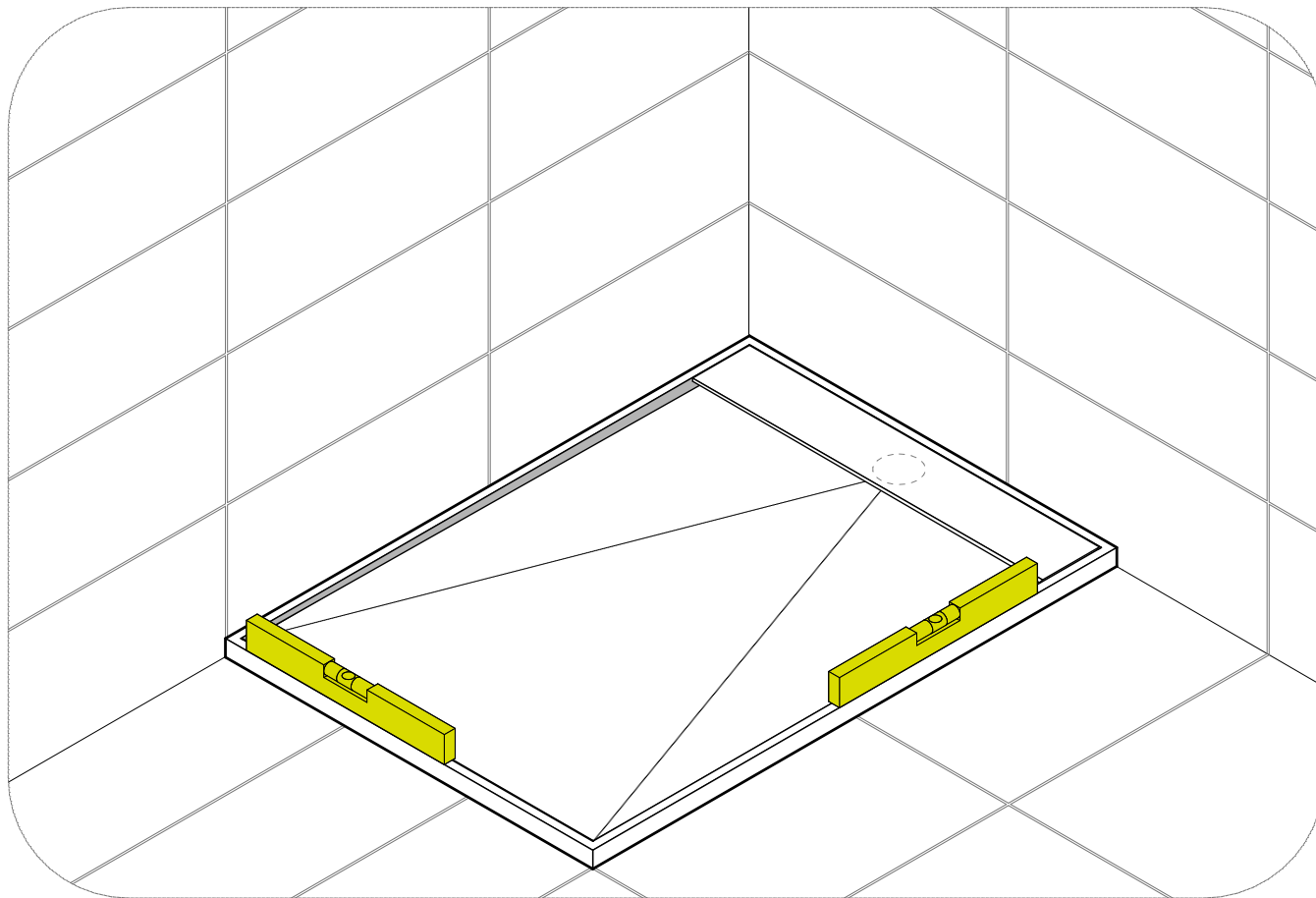

Mettere a livello il piatto doccia

*Level the shower tray*

**SLIM- piatto doccia in appoggio**  
**SLIM \_Floorstanding shower tray**

installazione  
installation

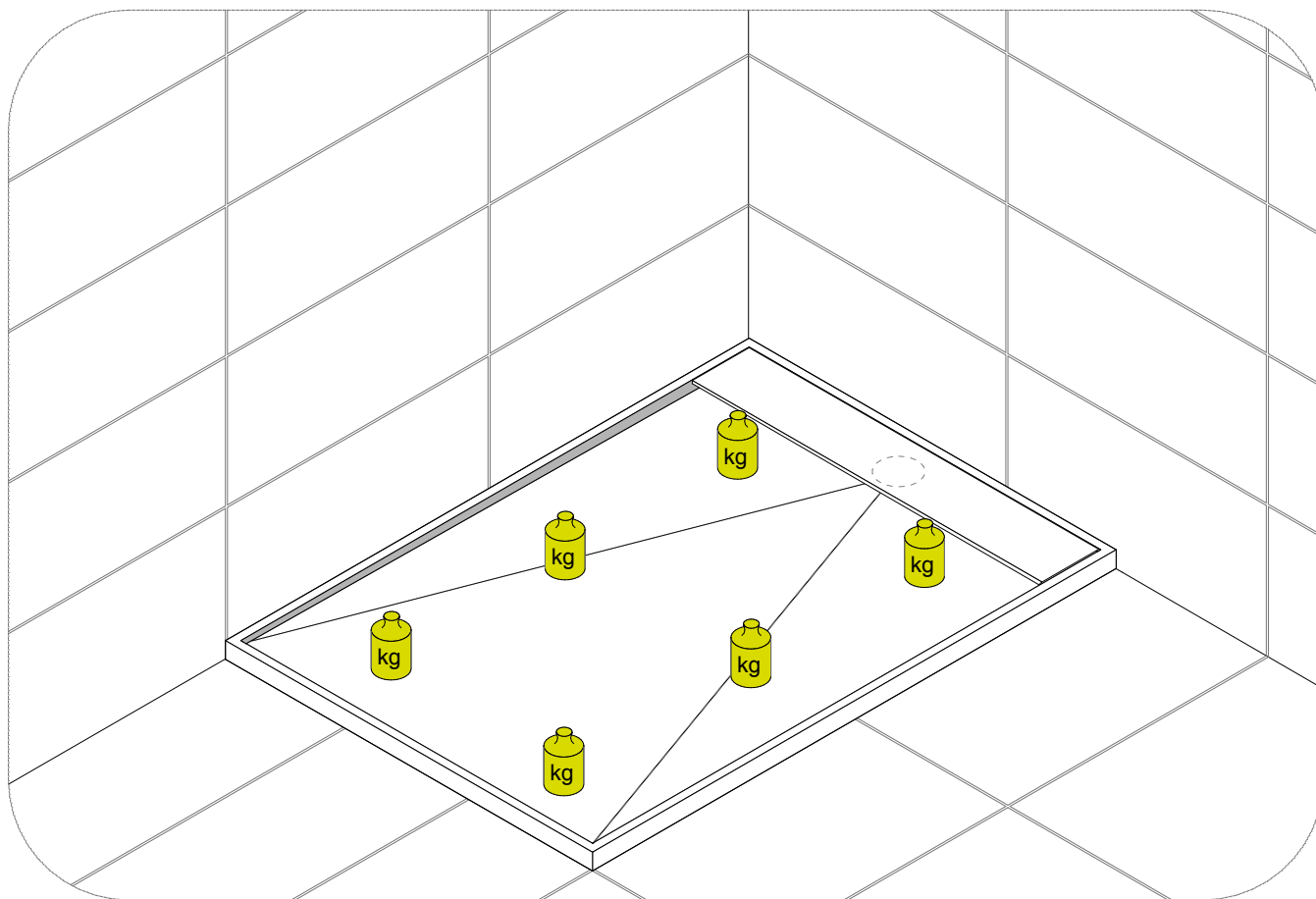

Distribuire uniformemente dei pesi sul piatto doccia per garantire l'incollaggio continuo al massetto.

*Distribute evenly some weights on the shower tray to glue it continuously to the screed.*