

Instruction

MOD545WL-09G

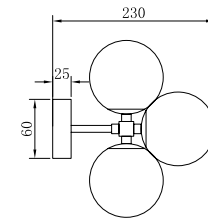
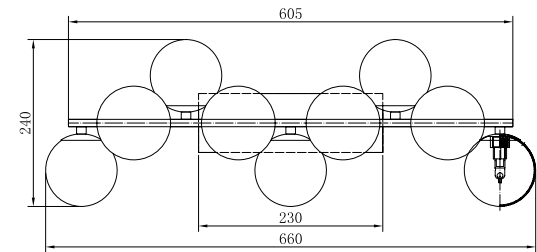
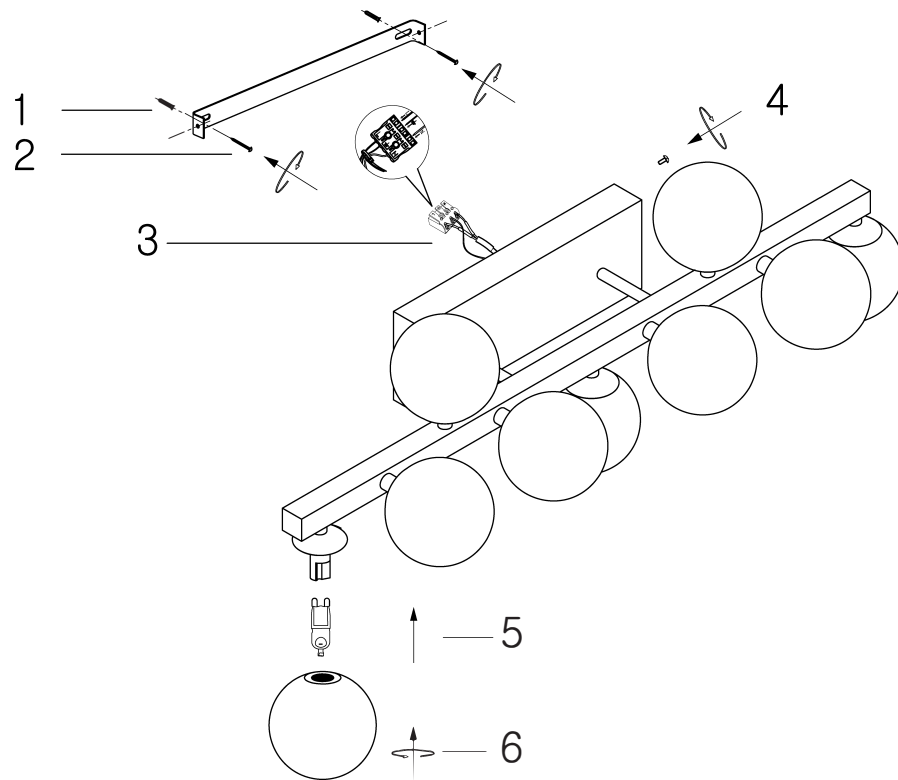

9 x G9 (28W)

Model: MOD545WL-09G

Collection: Modern



Wall Lamps