







27 502 370



- 225mm projection
- complete hand shower set: normal flow
- spout: circular, air-enriched flow
- complete hand shower set with anti-scale system
- automatic bath/shower diverter
- height of mixer 185 mm
- height up to aerator 140 mm
- hole diameter valve 32 mm
- hole diameter spout 32 mm
- hole diameter for complete hand shower set 32 mm
- rosette for spout Ø 70mm
- rosette for complete hand shower set Ø 60mm
- rosette for deck valve Ø 60mm
- metal shower hose 1750mm with integrated anti-twist protection
- max. spout flow rate 23 l/min
- max. flow for complete hand shower set 6.8 l/min

Intrinsic protection against back flow.

	Platinum	27 502 370-08
	Chrome	27 502 370-00
	Brushed Platinum	27 502 370-06
	Durabass (23kt Gold)	27 502 370-09
	Brushed Durabass (23kt Gold)	27 502 370-28
	Brushed Dark Platinum	27 502 370-99

Recommended miscellaneous



**Perfecto installation kit -** 12 614 970 90

27 502 370

mm [inches]  
1:10

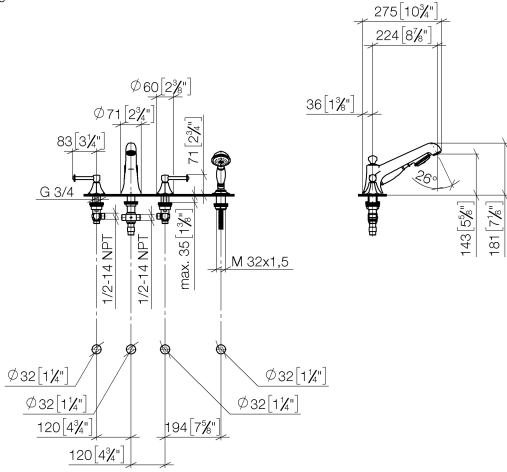

### Flow rate chart

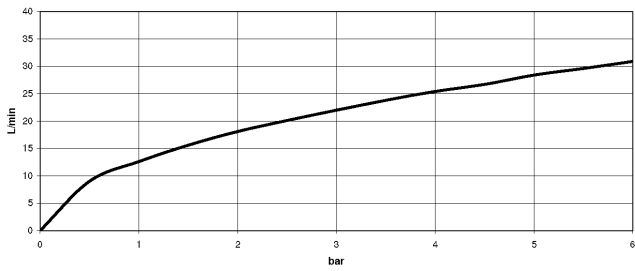

### Codes & Standards

DIN 4109

EN 1717

ISO 3822

Ü-Zeichen



MADISON Bath shower set for bath rim or tile edge installation - Platinum

MADISON

27 502 370

Certificates

LGA\_8

Belgaqua\_21-380-2

27 502 370

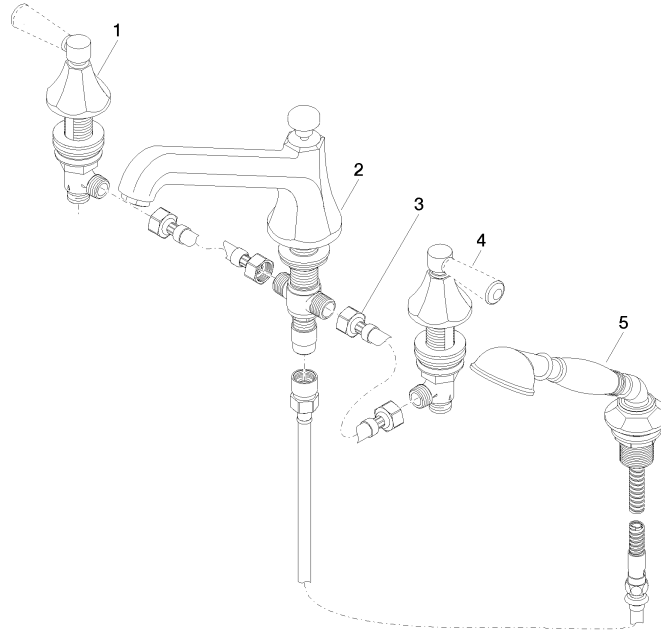



MADISON Bath shower set for bath rim or tile edge installation - Platinum

MADISON

27 502 370

**Spare parts list**

No.	Item Number	Name	Quantity used	Delivery time
	20 000 370-08	side panel	6	60