

SCHEDA TECNICA / TECHNICAL DATA

RUBINETTERIE RITMONIO S.R.L. si riserva tutti i diritti connessi con il presente documento e con l'oggetto o la materia ivi rappresentati con divieto di riprodurlo, utilizzarlo o renderlo accessibile a terzi in assenza di previa autorizzazione. Disegno CAD non modificabile a mano

RUBINETTERIE RITMONIO S.R.L. will claim all rights related to the present document and with the object or subject represented therein with the prohibition of reproduction, use or disclosure to third parties without previous permission. The Cad plan is not alterable by hand

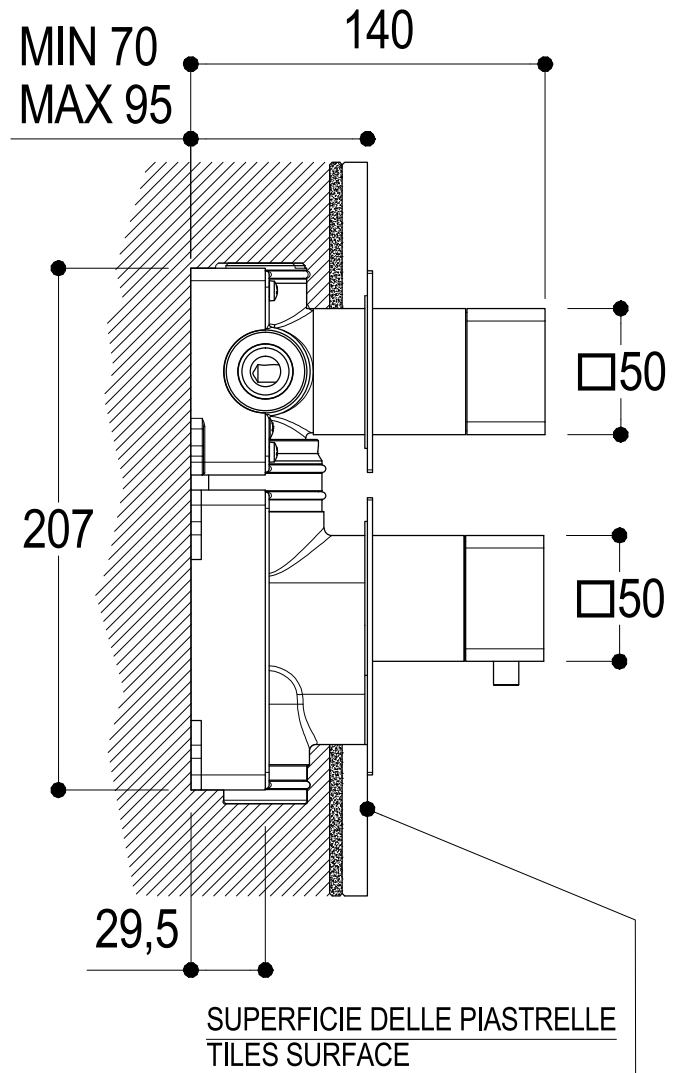
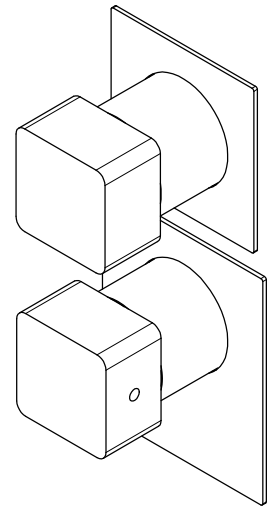
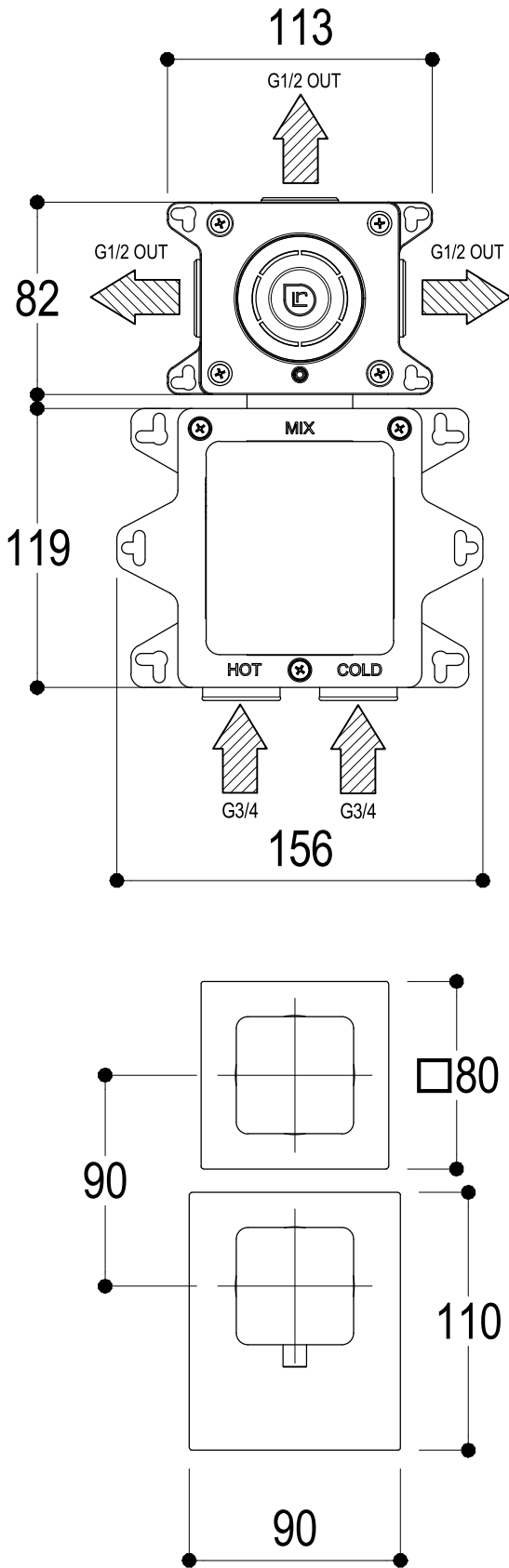

Ritmonio
Living a quality experience.
13019 VARALLO - (VC) - ITALY

SERIE COMANDI WELLNESS

CODICE PR47HF212

DATA EMISSIONE 04/10/18

DENOMINAZIONE
Miscelatore termostatico incasso 3 vie 2 comandi
Built-in thermostatic mixer with 3 ways diverter

REVISIONE /
/