

# Motion controller

## Modicon LMC058

Catalogue  
October 2012





- **Modicon LMC058 Motion controller**
- Selection guide* ..... 2
- Presentation ..... 4 to 10
- Description ..... 11
- References ..... 12
- **I/O expansion modules**
- Local and remote I/O expansion modules* ..... 14
- Distributed I/O expansion modules* ..... 15
- Modicon TM5
  - Compact blocks ..... 16 & 18
  - Digital modules ..... 20 to 25
  - Common distribution modules ..... 26
  - Analog modules ..... 28 to 31
  - Expert modules ..... 32 to 35
  - Power distribution modules ..... 36
  - Transmitter and Receiver modules ..... 38
- Modicon TM7 blocks ..... 40 to 51
  - Digital blocks ..... 42
  - Analog blocks ..... 46
  - Power distribution block ..... 49
- **Communication**
- Modicon TM5 communication module for Profibus DP fieldbus ..... 50
- Modbus and Character mode serial link Cabling system ..... 52
- Modicon TM5 communication modules for Modbus serial link ..... 54
- CANopen Performance architecture with Modicon TM5/TM7 ..... 56
- Distributed I/O on CANopen bus
  - with Modicon TM5 (IP 20) interface module ..... 58
  - with Modicon TM7 interface blocks IP 67 ..... 62
- CANopen Performance architecture with Modicon TM5 and Modicon TM7 ..... 72
- Ethernet Modbus/TCP network ..... 74
- **SoMachine software suite**
- Presentation ..... 76
- References ..... 79
- **Associated offers**
- Altivar 32 variable speed drives and Lexium 32 motion control ..... 80
- TeSys motor starters - open version ..... 82
- Power supplies Phaseo
  - Regulated switch mode power supplies ..... 84
- Operator dialogue terminals
  - Magelis Small Panels ..... 86
  - Magelis GT, GK, GH and GTW Advanced Panels ..... 88 & 90

<b>Applications</b>		<p><b>General machine control with motion:</b></p> <ul style="list-style-type: none"> <li><input type="checkbox"/> Packaging</li> <li><input type="checkbox"/> Conveying</li> <li><input type="checkbox"/> ...</li> </ul> <p><b>42 digital I/O</b></p>
<b>User memory</b>		<p>64 MB (program + data)</p> <p>128 MB</p>
<b>Typical Boolean instruction time</b>		22 ns
<b>User program size</b>		128 program Kinstructions
<b>Power supply</b>		24 V $\overline{\text{---}}$
<b>Channel connection</b>		Via removable spring terminal blocks (supplied)
<b>Inputs</b>		26 x 24 V $\overline{\text{---}}$ inputs including 8 counter inputs (100 kHz)
<b>Digital outputs</b>		16 outputs (0.5 A) including 4 reflex outputs
<b>Built-in communication ports</b>		<p>Programming port for SoMachine V2.0 software</p> <p>Connection of a USB memory stick for transferring programs, data files, firmware updates</p> <p>RS232 serial link</p> <p>RS485 serial link (supplies 250 mA, 5 V for HMI power supply)</p> <p>Protocols: Modbus ASCII/RTU Master/Slave, ASCII (character string)</p> <p>CANopen bus master (63 slaves)</p> <p>CANmotion bus master (8 synchronized axis or 63 slaves)</p> <p>Encoder input (incremental or SSI)</p> <p>Ethernet TCP IP, Web Server, FTP, Ethernet Modbus TCP</p>
<b>Optional communication ports</b>		–
<b>Motion controller type</b>		<b>LMC058 LF42</b>
<b>Page</b>		12





**General machine control with motion:**

- Packaging
- Conveying
- Machine control with motion

**42 digital I/O  
+ 4 analog inputs**



64 MB (program + data)

128 MB

22 ns

128 program Kinstructions

24 V  $\overline{\text{---}}$

Via removable spring terminal blocks (supplied)

26 x 24 V  $\overline{\text{---}}$  inputs including 8 counter inputs (100 kHz)

4 inputs  
+ 10 V/- 10 V, 4-20 mA/0-20 mA  
12-bit resolution

16 outputs (0.5 A) including 4 reflex outputs

–

Programming port for SoMachine V2.0 software

Connection of a USB memory stick for transferring programs, data files, firmware updates

RS232 serial link,  
RS485 serial link (supplies 250 mA, 5 V for HMI power supply)  
Protocols: Modbus ASCII/RTU Master/Slave, ASCII (character string)

CANopen bus master (63 slaves)

CANmotion bus master (8 synchronized axis or 63 slaves)

Encoder input (incremental or SSI)

Ethernet TCP IP Modbus slave, Web Server, FTP

2 PCI slots available on controller for optional communication modules TM5 PC●●● (1):

- Modbus or ASCII serial link
- connection to Profibus DP bus (slave)

**LMC058 LF424**

12

(1) To be ordered separately, see page 54.



Modicon LMC058 motion controller

The Modicon LMC058 motion controller is the optimum solution for axis control and positioning, including automation functions. It forms a part of Flexible Machine Control approach, a key component of MachineStruxure™, which brings you maximum flexibility and ensures the most optimised control solution. The Modicon LMC058 motion controller meets the needs of a wide range of applications in all business sectors.

This motion controller is designed for machine manufacturers (OEMs) who require synchronized axes, focusing on applications such as packaging, conveying and storage machines, metal and wood working machines, etc. and offers high-performance solutions for velocity control, counting, axis control and communication functions.

To this end, the LMC058 master motion controller includes as standard:

- A CANopen master
- A CANmotion master dedicated to control of up to 8 synchronized axes, with a performance of 2 ms for 4 axes

With Motion controllers Modicon LMC058, Lexium 32 and Lexium SD3 drives, and BSH and BDH servo motors, Schneider Electric offers a complete, high-performance and cost-effective solution.

## Applications

The Modicon LMC058 motion controller performs axis synchronization and coordination, via a fieldbus, for applications requiring control of up to 8 synchronized axes.

It integrates the standard motion control functions:

- Velocity control and torque control
- Relative or absolute positioning
- Cam profiles for slave axes and control of programmable cam switches
- Virtual axes
- Electronic gearing function for velocity and position, linear and circular interpolations (2½D)
- Master axis using an external encoder
- Distance measurement and position capture on high-speed (30 µs) digital input

This is specifically designed for applications such as:

- Material handling machines (conveyors, palletizers, storage and retrieval systems, etc.) and transfer machines (cranes, etc.)
- Assembly machines (tool fixing, clamping, etc.)
- Inspection and quality control machines
- Packaging machines working "on the fly" (flying shear, printing, marking, etc.)
- Wood and metal working machines

## Performance

In terms of performance, the Modicon LMC058 motion controller has a Dual-Core processor:

- Core 1 is dedicated exclusively to managing program tasks and offers the maximum resources for real-time execution of synchronized axis control and the application code.
- Core 2 is dedicated to executing communication tasks, which then have no further impact on the application execution performance.

Execution of the Motion task is synchronized with the CANmotion bus cycle time. This task calculates the position of the synchronized axes and is programmed with SoMachine software, which is used to program Modicon LMC058 motion controller using:

- IEC 61131-3 programming languages: Instruction List (IL), Ladder Diagram (LD), Function Block Diagram (FBD), Sequential Function Chart/Grfcet (SFC) and Structured Text (ST)
- CFC (Continuous Function Chart) language.

See page 76.

The ease of use of PLCopen function blocks significantly reduces the time taken to program motion control and control independent and synchronized axes on machines.

The ability to combine motion functions with standard automation functions offers both maximum flexibility and a high level of performance. The LMC058 master motion controller is able to control synchronization of real, remote and virtual axes.



### Performance (continued)

To improve the performance and reliability of your machines, the LMC058 motion controller has a 15-way SUB-D connection for a master encoder (incremental or SSI).

With an execution speed of **22 ns** for a Boolean instruction i.e. more than **45,000 Boolean instructions** per ms, the capacity to manage up to **2400 I/O**, a **64 MB RAM** that can store data and programs as well as a **128 MB Flash** memory for application and data backup, the Modicon LMC058 motion controller greatly enhances the machine's capabilities.

In developing the Modicon LMC058 motion controller, the cost aspect was taken into account, and the CPUs are equipped as standard with:

- 42 digital I/O
- Embedded serial link and Ethernet port
- 4 analog inputs (reference LMC058LF424)
- A CANopen master
- A CANmotion master

### Development and technology

In all its characteristics, the Modicon LMC058 motion controller has been developed to minimize the costs of assembly, cabling, commissioning and maintenance.

To this end:

- All the modules have removable terminals.
- All the electrical connections are made on spring terminals, speeding up the wiring process and also avoiding the need for periodic retightening. In addition, each terminal has a test point for a voltage sensing device.
- The embedded serial link and Ethernet port on the Modicon LMC058 motion controller have an RJ45 connection at 45° for quick visible connection of the communication channels.
- The modularity of the various bases and expansion modules has been optimized in order to significantly reduce the number of references to be ordered and assembled, while ensuring the minimum investment in your configuration is necessary, thanks to a capacity of between 2 and 42 channels per expansion module.
- Mechanical assembly of the various parts has been designed to save a considerable amount of time during assembly.

### Software configuration

Configuration and programming of all Modicon LMC058 motion controllers and equipment in Schneider Electric's "Flexible Machine Control" concept are both designed to cut costs and optimize machine performance, using SoMachine.

To reduce the configuration time of device, a selection of function blocks is available in the "Motion Library":

- Library for ATV on CANopen
- Lexium library for Lexium 32 and Lexium SD3 on CANopen and CANmotion
- Lexium library for the whole ILx range on CANopen

This PLCopen-compliant library consists of administrative function blocks (read/write parameters, states, etc.) and single-axis and multi-axis function blocks.

The main functions are as follows:

- Power On, stop, reset
- Relative, absolute or additional positioning
- Continuous positioning (reaching a position at a predefined speed)
- Velocity control
- Velocity profile
- Position profile
- Cam profile
- Electronic gearing
- Phasing
- Programmable cam switch
- Linear or circular interpolation

#### User library

With SoMachine software, it is very easy to create your own function blocks (user library) to reduce programming times. Creating a user library simplifies the standardization and reuse of programs and also allows the user to protect proprietary information.



SoMachine software platform

## Application function blocks (AFB)

This is a library of functions developed specifically by Schneider Electric. It contains application functions currently encountered in applications in the fields of assembly, material handling and cut to length applications. Each function block has a large number of mechanical and application variants.

The use of function blocks:

- Saves programming time
- Saves setup time
- Simplifies reading

The function blocks available in the library are:

- Flying shear
- Rotary knife
- Grouping/ungrouping
- Clamping with torque control
- Etc.

*Nota: AFB are available only on the type S motion controllers : LMC058●●S0 with SoMachine extension. See page 79.*

## Functions

### Analog functions

For machines that require functions to process data issued by analog sensors/actuators (voltage or current), temperature sensors or PID control sensors, a complete range of expansion modules as well as advanced programming functions are included in the Modicon LMC058 motion controller offer.

In order to minimize the number of machine product references, optimize assembly time and cut costs, the LMC058LF424 motion controller includes 4 voltage or current analog inputs with 12-bit resolution as standard.

The different expansion modules are available in 2, 4 or 6-channel versions and with either 12 or 16-bit resolution.

The powerful performance of the LMC058 motion controller enables up to 200 analog I/O and/or temperature modules to be connected, thus extending the limits of machine requirements.

### High-speed counter function (HSC)

In order to meet requirements for machine productivity, the LMC058 motion controller has 8 embedded high-speed counters with a counting frequency of 200 kHz for each channel and 4 reflex outputs.

These embedded counters, together with the CANopen master link, make it quick and easy to create cost-effective, high-performance multi-axis functions to suit the machines' limitations.

With the availability of PLCopen function blocks specific to the motion control functions in the SoMachine software, you can be sure that developing your applications will be quick and reliable.

Moreover, a complete range of high-speed counter modules is available so you can adapt your configuration to your machine's specific requirements.

### Position control function

Several options are offered in terms of position control:

- Creating a sequence in Lexium 32 servo drives, with communication with the LMC058 motion controller achieved by the use of digital I/O
- Creating an application in the LMC058 motion controller and controlling Lexium 32 drives and servo drives and/or Lexium SD3 stepper drives via the integrated CANopen master link available on LMC058 motion controllers (in this case the Motion tasks are independent axis Motion tasks)
- Creating an application in the LMC058 motion controller and controlling the Lexium 32 drives and servo drives and/or Lexium SD3 stepper drives via the integrated CANmotion master link available on all LMC058 motion controllers (in this case the Motion tasks are independent and/or synchronized axis Motion tasks - cam profiles, electronic gearing, interpolation)

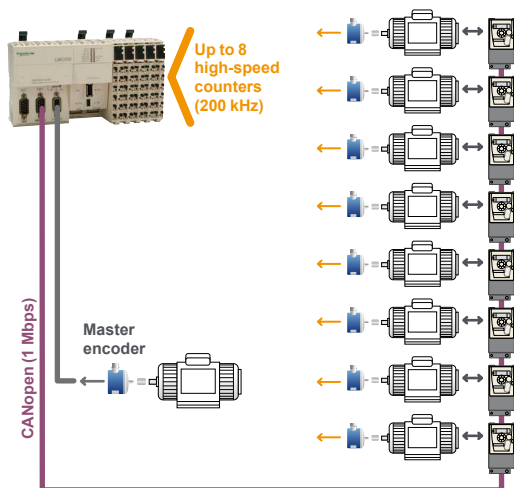

High-speed counter function (one-phase or two-phase)

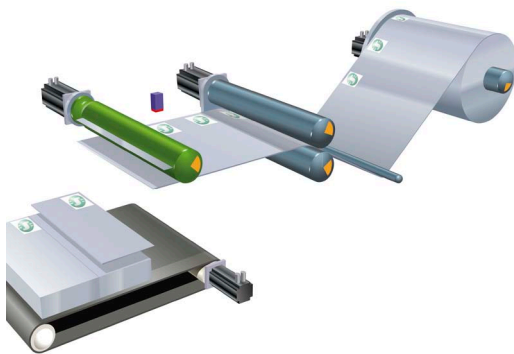

Lexium 32 servo drives: monitoring cutting to length

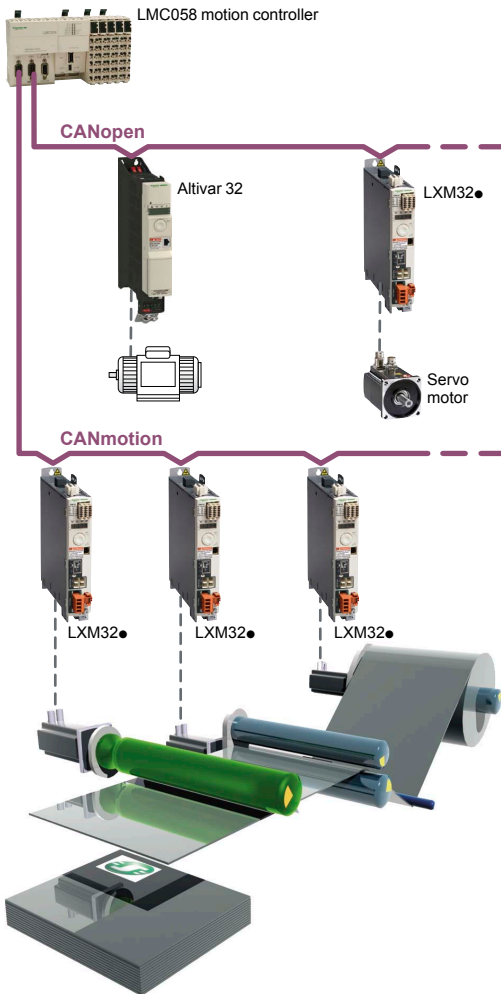

## Ethernet communication

All Modicon LMC058 motion controller references have an embedded RJ45 Ethernet port (10/100 Mbps, MDI/MDIX) with Ethernet TCP Modbus, Ethernet IP Device, SoMachine on Ethernet, UDP, TCP and SNMP protocols.

In addition, all the LMC058 motion controllers have an embedded Web Server and FTP Server. As well as the default address based on the MAC address, it is possible to assign a motion controller IP address via a DHCP server or BOOTP server.

## CANmotion/CANopen communication

The CANopen machine bus is now very widely used in industry because of its high performance. In accordance with international standard ISO 11898 promoted by the CAN in Automation association of users and manufacturers, it offers a high level of openness and interoperability thanks to its standardized communication and equipment profiles.

CANmotion and CANopen buses use a double shielded twisted pair. Each end of the bus must be equipped with a line terminator.

A staged CANmotion and CANopen connectivity solution reduces costs and optimizes your architecture, thanks to:

- Reduced cabling time
- Greater reliability of the cabling
- Flexibility should you need to add or remove a device

## CANmotion

All Modicon LMC058 motion controller references have an embedded CANmotion master.

This bus is dedicated to synchronizing the drives (conforming to standard CiA DSP 402, the Device Profile for Drives & Motion Control).

This CANmotion link can be configured between 250 kbps and 1 Mbps, and offers the option of configuring and controlling up to 8 Lexium 32 servo drives and/or Lexium SD3 stepper drives.

The CANmotion bus cycle time ensures that the axis positions will be refreshed. To ensure maximum performance on the motion bus, we recommend using a daisy chain cabling architecture.

## CANopen

All Modicon LMC058 motion controller references have an embedded CANopen master.

This bus is dedicated to expansion of the automation capabilities, such as the I/O, drives, encoders, etc.

The link can be configured between 125 kbps and 1 Mbps and supports up to 63 slaves. Architectures based on CANopen can be used to distribute I/O modules as close to the sensors and actuators as possible, thus reducing wiring costs and times, and to communicate with different devices such as variable speed drives, servo drives, etc.

The CANopen configurator is integrated in the SoMachine software and can also be used to import standard description files in EDS format.

## Modbus communication

All motion controllers Modicon LMC058 have a serial link as standard that can be configured as either RS232 or RS485 and incorporates the two most commonly used protocols on the market:

- Modbus ASCII/RTU Master or Slave
- Character string (ASCII)

## Profibus DP (Decentralized Peripherals)

The Modicon LMC 058LF424 motion controller equipped with the **TM5PCDPS** communication module can be connected to Profibus bus for controlling decentralized sensors, actuators or PLCs via a central master controller.

## Integration in the Schneider Electric product offer

Combined with other products dedicated to machine manufacturers in the Schneider Electric offer, such as ATV variable speed drives, Lexium servo drives, Magelis HMI terminals, TeSys motor starters and contactors, the Modicon LMC058 motion controller is now a must-have element in machine architectures, with hitherto unrivalled ease and speed of installation.



LMC058LF42 motion controller



LMC058LF424 motion controller

TM5PC communication modules



TM5C compact block



TM5SD digital module



TM5SMM6D2L digital/analog module



TM5SA analog module



TM5SE Expert module



TM5SPD Common Distribution module



TM5SPS Power Distribution modules



TM5SBET1 transmitter module



TM5SBER2 receiver module

## Presentation

### Range

The LMC058 motion controller range is divided into two sizes:

- The LMC058LF42 motion controller is 177 mm wide.
- The LMC058LF424 motion controller is 237.5 mm wide as it has two free PCI slots for optional Modicon TM5 communication modules (Modbus or ASCII serial link, connection to Profibus DP bus).

This range is completed by an extensive expansion module offer:

- Modicon TM5 Compact blocks
- Modicon TM5 Digital modules
- Modicon TM5 Digital/Analog module
- Modicon TM5 Analog modules
- Modicon TM5 Expert modules
- Modicon TM5 Common Distribution modules
- Modicon TM5 Power Distribution modules
- Modicon TM5 Transmitter and receiver modules

### Functions

The main component in a system is the motion controller: two LMC058 motion controller models are offered to cover different control requirements (pressure, temperature, counting, velocity, positioning, motion, etc.).

LMC058 motion controllers and I/O modules are programmed using SoMachine software.

Reference	Embedded functions
LMC058LF42	<ul style="list-style-type: none"> <li>■ 42 digital I/O including 8 high-speed counters (200 kHz)</li> <li>■ CANopen master</li> <li>■ CANmotion master</li> </ul>
LMC058LF424	<ul style="list-style-type: none"> <li>■ 42 digital I/O including 8 high-speed counters (200 kHz)</li> <li>■ 4 voltage/current analog inputs</li> <li>■ CANopen master</li> <li>■ CANmotion master</li> </ul>

All LMC058 motion controllers have two groups of high-speed I/O with, for each group:

- Four sink type high-speed inputs (up to 200 kHz), 2 standard inputs and 2 source type high-speed outputs (up to 100 kHz) dedicated to HSC or PWM functions
- A high-speed input which can be used as an "Encoder capture input"
- Two commons for the inputs
- One common for the outputs
- A power supply (24 V  $\pm$ ) consisting of 3 units:
  - One for the CPU
  - One for the high-speed I/O modules
  - One for other modules (internal I/O Bus).

## Conformity to standards

Type	Performance	
Surge immunity 24 VDC circuit	EN/IEC 61000-4-5	1 kV in common mode 0.5 kV in differential mode
Surge immunity 230 VAC circuit	EN/IEC 61000-4-5	2 kV in common mode 1 kV in differential mode
Induced electromagnetic field	EN/IEC 61000-4-6	10 Veff (0.15...80 MHz)
Conducted emission	EN 55011 (IEC/CISPR11)	150...500 kHz, quasi peak 79 dB $\mu$ V 500 kHz...30 MHz, quasi peak 73 dB $\mu$ V
Radiated emission	EN 55011 (IEC/CISPR11)	30...230 MHz, 10 m @ 40 dB $\mu$ V/m 230 MHz...1 GHz, 10 m @ 47 dB $\mu$ V/m



## Assembly and mounting

The components of this system have been designed for simple interlocking mechanical assembly.

An 8-way expansion bus connection (2 for the power supply, 2 for the bus and 4 for the data) is used to distribute data and the power supply when assembling the components: the LMC058 motion controller with compact blocks and modules (Digital, analog, Expert, Common Distribution, Power Distribution, bus expansion). All the elements which make up the system are mounted on a symmetrical rail using the locking levers located on top of each device.

Wiring and maintenance of devices is simplified by the use of removable spring terminals. The spring terminals are undone by pressing a locking tab.

The system is integrated into communication networks: all connectors (RJ45, USB, mini-USB and SUB-D type) are accessible, as they are located on the motion controller front panels.

## Local or remote architecture

### Local I/O

A PLC configuration can be local or remote. It consists of an LMC058 motion controller with its embedded input and output channels, used in conjunction with compact blocks and/or expansion modules which are used to increase the number of channels and/or application-specific functions.

- Compact blocks represent a way of adding a large number of I/O with a single component, and thus only a single product reference.
- I/O modules (combination of a bus base, an electronic module and a terminal block) complete this configuration and, being modular with between 2 and 12 channels, make it possible to adjust the number of channels to exactly that required. The addition of digital or analog modules, temperature or high-speed counter modules increases the processing capabilities of applications.

### Local I/O configuration

- 1 XBTGT supervisory graphic touch screen terminal
- 2 LMC058 motion controller
- 3 Compact blocks or I/O modules

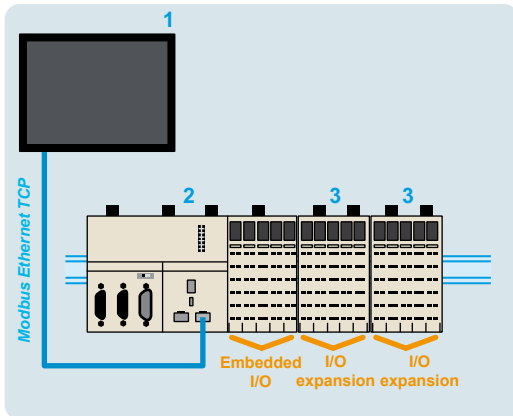

Local I/O

### Remote I/O

Because of its backplane bus management, the TM5 system can be used to control I/O remotely.

The same modules can be used in either a local and/or remote configuration, linked together with bus expansion cables.

The maximum distance between two remote islands is 100 m and the maximum number of islands is 25, i.e. a total distance of up to 2500 m.

This function ensures a high level of flexibility, while retaining **synchronization of all data acquisition**, since all the expansion modules are on the same backplane bus.

### Remote I/O configuration

- 1 XBTGT supervisory graphic touch screen terminal
- 2 LMC058 motion controller
- 3 Compact blocks or I/O modules
- 4 Transmitter modules
- 5 Receiver modules
- 6 TM5 expansion bus cables
- 7 Common distribution modules

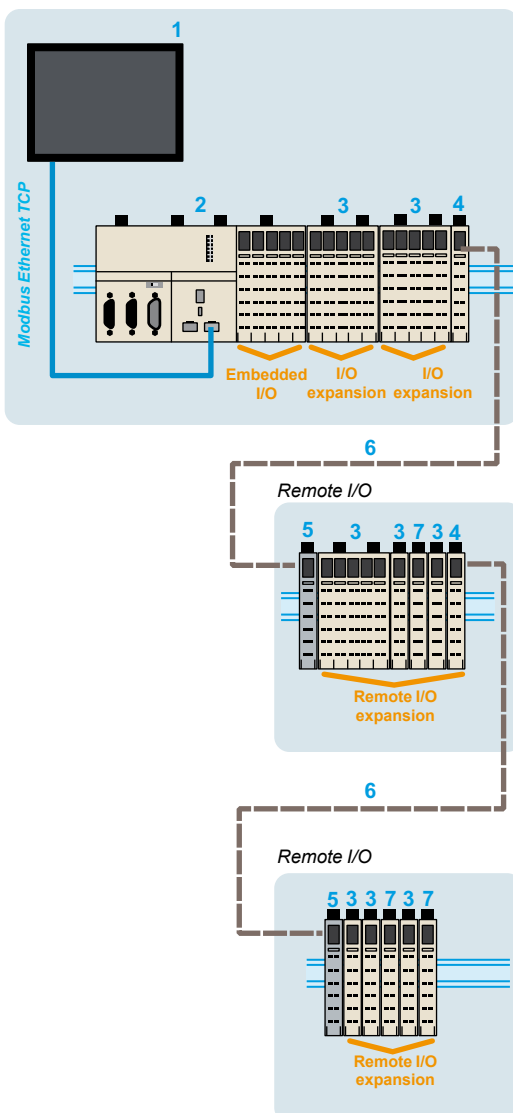

## Communication

LMC058 motion controllers have the following built-in communication ports:

References	Communication ports	Use
<b>LMC058LF42</b>	RJ45 Configurable as RS232 or RS485	ASCII or RTU exchange with Modbus communication protocol
	1 x RJ45 (MDI/MDIX port)	<input type="checkbox"/> FTP server <input type="checkbox"/> Web server <input type="checkbox"/> Modbus TCP server <input type="checkbox"/> Modbus TCP client <input type="checkbox"/> SoMachine Manager <input type="checkbox"/> SNMP <input type="checkbox"/> Ethernet IP device <input type="checkbox"/> Modbus device
	1 x USB-A	Connection of a USB memory stick for transferring (uploading/downloading) programs, data and/or firmware
	1 x mini-USB	Programming port (480 Mbps)
	1 x 9-way male SUB-D	CANopen master connection
	1 x 9-way male SUB-D	CANmotion master connection
	1 x 15-way female SUB-D	Master encoder
<b>LMC058LF424</b>	RJ45 Configurable as RS232 or RS485	ASCII or RTU exchange with Modbus communication protocol
	1 x RJ45 (MDI/MDIX port)	<input type="checkbox"/> FTP server <input type="checkbox"/> Web server <input type="checkbox"/> Modbus TCP server <input type="checkbox"/> Modbus TCP client <input type="checkbox"/> SoMachine Manager <input type="checkbox"/> SNMP <input type="checkbox"/> Ethernet IP device <input type="checkbox"/> Modbus device
	1 x USB-A	Connection of a USB memory stick for transferring (uploading/downloading) programs, data and/or firmware
	1 x mini-USB	Programming port (480 Mbps)
	1 x 9-way male SUB-D	CANopen master connection
	1 x 9-way male SUB-D	CANmotion master connection
	1 x 15-way female SUB-D	Master encoder
	2 PCI slots for communication modules = 2 x 9-way male SUB-D	Addition of optional communication modules for a serial link and a connection on the bus Profibus DP

## Embedded Ethernet

LMC058 motion controllers have an embedded Ethernet link via a direct connection to their RJ45 port.

- Speed: "10 BaseT" and "100 BaseTX" with auto-negotiation
- RJ45 port (MDI/MDIX): automatic adaptation to a straight or crossed cable

References	Protocols	Number of connections
<b>LMC058LF42</b>	Modbus server	8
<b>LMC058LF424</b>	Modbus device	2
	Ethernet IP device	16
	FTP server	4
	Web server	10



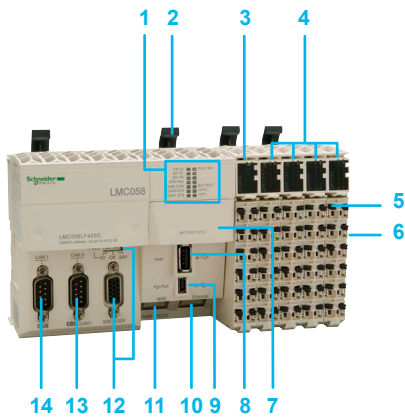

## Description

### The LMC058LF42 motion controller comprises:

- 1 A display block with:
  - 4 motion controller status LEDs (RUN/MS, BATTERY, APP0 and APP1)
  - 7 built-in communication port status LEDs (*Eth* LA, *Eth* ST, *Eth* NS, USB Host, MBS COM, CAN 0 STS, CAN 1 STS)
- 2 Locking lever for mounting/dismounting on  $\perp$  symmetrical rail
- 3 A 24 V  $\overline{\text{DC}}$  power supply module with removable terminal block and locking lever, display block and slot for a label
- 4 I/O modules, each one with a removable terminal block with locking lever, a display block showing the I/O states and a slot for a label-holder
- 5 Removable terminal block with locking lever for locking/unlocking
- 6 On the side, an expansion bus connector for connecting to the next module
- 7 A slot for the RTC (Real Time Clock) battery
- 8 A USB-A connector (marked Host) for connecting a USB memory stick for transferring programs, data or firmware updates
- 9 A USB-B mini-connector (marked Pgr Port) for connecting to the programming PC
- 10 An RJ45 connector (marked Ethernet) for connecting to the Ethernet network and/or Magelis XBTGT graphic terminal
- 11 An RJ45 connector (marked MBS) for the RS232 or RS485 serial link
- 12 A 15-way female SUB-D connector, marked ENCODER, for connecting the master encoder and a selector switch for the 3 encoder supply voltage states (5 V, Off, 24 V)
- 13 A 9-way male SUB-D connector, marked CAN0, for connecting to the CANopen bus
- 14 A 9-way male SUB-D connector, marked CAN1, for connecting to the CANmotion bus

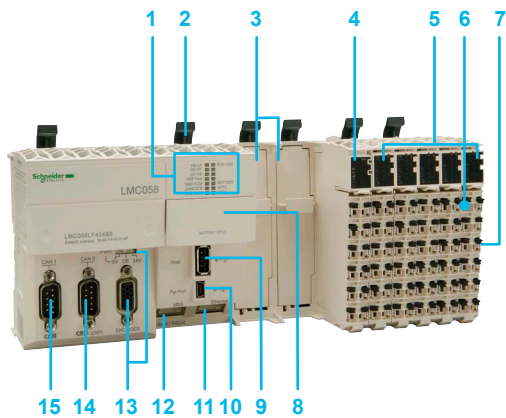

### The LMC058LF424 motion controller comprises:

- 1 A display block with:
  - 4 motion controller status LEDs (RUN/MS, BATTERY, APP0 and APP1)
  - 7 built-in communication port status LEDs (*Eth* LA, *Eth* ST, *Eth* NS, USB Host, MBS COM, CAN 0 STS, CAN 1 STS)
- 2 Locking lever for mounting/dismounting on  $\perp$  symmetrical rail
- 3 Two free PCI slots for the communication modules
- 4 A 24 V  $\overline{\text{DC}}$  power supply module with removable terminal block and locking lever, display block and slot for a label
- 5 I/O modules, each one with a removable terminal block with locking lever, a display block showing the I/O states and a slot for a label-holder
- 6 Removable terminal block with locking lever for locking/unlocking
- 7 On the side, an expansion bus connection for the link with the next module
- 8 A slot for the RTC (Real Time Clock) battery
- 9 A USB-A connector (marked Host) for connecting a USB memory stick for transferring programs, data or firmware updates
- 10 A USB-B mini-connector (marked Pgr Port) for connecting to the programming PC
- 11 An RJ45 connector (marked Ethernet) for connecting to the Ethernet network and/or Magelis XBTGT graphic terminal
- 12 An RJ45 connector (marked MBS) for the RS232 or RS485 serial link
- 13 A 15-way female SUB-D connector, marked ENCODER, for connecting the master encoder and a selector switch for the 3 encoder supply voltage states (5 V, Off, 24 V)
- 14 A 9-way male SUB-D connector, marked CAN0, for connecting to the CANopen bus
- 15 A 9-way male SUB-D connector, marked CAN1, for connecting to the CANmotion bus



LMC058LF42



LMC058LF424

## References

LMC058 motion controllers, 24 V  $\overline{\text{---}}$  power supply (1)

No. of I/O	Inputs	Outputs	Built-in communication ports	Reference	Weight (kg)
42 I/O	<ul style="list-style-type: none"> <li>■ 26 x 24 V <math>\overline{\text{---}}</math> digital inputs including 8 counter inputs (200 kHz)</li> </ul>	<ul style="list-style-type: none"> <li>■ 16 digital transistor outputs (0.5 A) including 4 reflex outputs</li> </ul>	<ul style="list-style-type: none"> <li><input type="checkbox"/> 1 RJ45 port: Ethernet</li> <li><input type="checkbox"/> 1 SUB-D port (9-way male): CANopen master</li> <li><input type="checkbox"/> 1 SUB-D port (9-way male): CANmotion master</li> <li><input type="checkbox"/> 1 SUB-D port (15-way female): master encoder</li> <li><input type="checkbox"/> 1 USB-A port: program transfer</li> <li><input type="checkbox"/> 1 USB-B mini-port: software programming</li> <li><input type="checkbox"/> 1 RJ45 port: RS232/RS485 serial link</li> </ul>	<b>LMC058LF42</b>	0.550
42 + 4 I/O	<ul style="list-style-type: none"> <li>■ 26 x 24 V <math>\overline{\text{---}}</math> digital inputs including 8 counter inputs (200 kHz)</li> <li>■ 4 analog inputs 10 V/- 10 V, 4-20 mA/ 0-20 mA, 12-bit resolution</li> </ul>	<ul style="list-style-type: none"> <li>■ 16 digital transistor outputs (0.5 A) including 4 reflex outputs</li> </ul>	<ul style="list-style-type: none"> <li><input type="checkbox"/> 1 RJ45 port: Ethernet</li> <li><input type="checkbox"/> 1 SUB-D port (9-way male): CANopen master</li> <li><input type="checkbox"/> 1 SUB-D port (9-way male): CANmotion master</li> <li><input type="checkbox"/> 1 SUB-D port (15-way female): master encoder</li> <li><input type="checkbox"/> 1 USB-A port: program transfer</li> <li><input type="checkbox"/> 1 USB-B mini-port: software programming</li> <li><input type="checkbox"/> 1 RJ45 port: RS232/RS485 serial link</li>   <li><input type="checkbox"/> + 2 free PCI slots for optional communication modules (2): RS232/RS485 serial link and Profibus DP bus</li> </ul>	<b>LMC058LF424</b>	0.770

(1) The motion controllers Modicon LMC058 require a power supply with a nominal voltage of 24 V  $\overline{\text{---}}$ . The 24 V  $\overline{\text{---}}$  power supply must be rated Separated Extra Low Voltage (SELV-rated) according to IEC 61140. The SELV-rating means that SELV isolation is provided between the electrical input and output of the power supply.  
 (2) To be ordered separately, see page 54.

References						
Accessories						
Designation	Used for	Colour	Sold in lots of	Unit reference	Weight kg	
<b>Plain text cover holder (label-holder)</b>	Labelling the terminal blocks on the I/O channels	Transparent	100	TM5ACTCH100	0.002	
<b>Terminal block shield locking clip</b> (Order with plain text cover holder TM5ACTCH100)	Locking plain text cover holder TM5ACTCH100	Transparent	100	TM5ACTLC100	0.001	
<b>Sheet of 92 precut paper labels</b>	Plain text cover holder TM5ACTCH100	White	100	TM5ACTLS100	0.001	
<b>Coloured plastic markers</b>	Labelling 16 connection channel terminals	White	1	TM5ACLITW1	0.015	
		Red	1	TM5ACLITR1	0.015	
		Blue	1	TM5ACLITB1	0.015	
<b>Metal tool</b>	Inserting/removing TM5ACLIT●1 markers	Black	1	TM5ACLT1	0.030	
Connection cables						
Designation	Used from	to	Length	Reference	Weight kg	
<b>Software programming cable</b> Baud rate: 480 Mbps max. Protocol: Modbus, HTTP, FTP, Codesys or virtual, non-isolated	PC USB port	USB mini-port on LMC058 motion controllers, the ATV-IMC card or XBTGT graphic touch screen terminals	3 m	TCSXCNAMUM3P	0.065	
<b>RS485 serial link cables</b> Modbus protocol	SUB-D port (25-way) on Small Panels: XBTN401, XBTN410, XBTR410, XBTR411, XBTGT2... GT7	RJ45 port on LMC058 motion controllers	1.8 m	XBTZ938	0.230	
		RJ45 port on XBTGT graphic touch screen terminals	2.5 m	XBT9980	0.230	
<b>RS232 serial link cables</b> Character mode	SUB-D port (9-way female) on DTE (1): printer, hand-held bar code reader, etc.	RJ45 port on LMC058 motion controllers	3 m	TCSMCN3M4F3C2	0.150	
		SUB-D port (9-way female) on DCE (2): GSM modem	3 m	TCSMCN3M4M3S2	0.150	
<b>Cable for master encoder input</b>	Incremental encoders or SSI serial absolute encoders (1 stripped end)	15-way female SUB-D port on LMC058 motion controllers (1 High Density 15-way male SUB-D connector)	1 m	VW3M4701	–	

(1) DTE: Data Terminal Equipment

(2) DCE: Data Communication Equipment



TM5ACTLC100



TM5ACTCH100

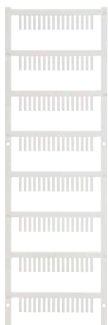





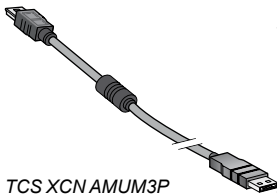

TM5ACLITW1



TM5ACLT1

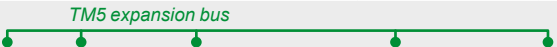

TCSXCNAMUM3P

Applications		Local and/or remote I/O (IP 20)				Remote I/O expansion bus (IP 67)		
Compatibility		<ul style="list-style-type: none"> <li>■ Modicon M258 logic controller</li> <li>■ Modicon LMC058 Motion controller</li> </ul>						
I/O type		Digital	Analog	Digital/analog	Expert	Digital	Analog	
Remote I/O	Hardware configuration	 <p>Modicon TM5 transmitter/receiver: For use with remote I/O (1)</p>				 <p>Modicon TM5 transmitter/receiver: Required (1)</p>		
	Bus type	 <p>TM5 expansion bus</p>				 <p>TM7 expansion bus</p>		
								
Inputs	Number (depending on model)	2 to 12 inputs	2 to 6 inputs	Digital: 12 to 14 inputs Analog: 4 inputs	1 or 2 channels with 2 inputs	8 to 16 inputs	2 to 4 inputs	
	Type (depending on model)	24 V $\overline{\text{DC}}$ 100/120 V $\sim$ , 100/240 V $\sim$	Voltage, Current, Temperature	Digital: 24 V $\overline{\text{DC}}$ Analog: Voltage, Current	5 V $\overline{\text{DC}}$ , 24 V $\overline{\text{DC}}$ (from 50 kHz to 1 MHz)	24 V $\overline{\text{DC}}$	Voltage, Current, Temperature Resistance	
Outputs	Number (depending on model)	2 to 12 outputs	2 to 4 outputs	Digital: 6 to 18 outputs Analog: 2 outputs	–	8 to 16 outputs	2 to 4 outputs	
	Type (depending on model)	24 V $\overline{\text{DC}}$ 30/230 V $\sim$ , 100/240 V $\sim$	- 10...+ 10 V, 0...20 mA	Digital: 24 V $\overline{\text{DC}}$ Analog: Voltage/ Current	–	24 V $\overline{\text{DC}}$ Transistor/Source	- 10...+ 10 V, 0...20 mA	
Type of expansion module	Modicon TM5 digital module	Modicon TM5 analog module	Modicon TM5 compact block	Modicon TM5 expert module	Modicon TM7 digital block	Modicon TM7 analog block		
Page	20	28	16	32	40	40		

(1) Modicon TM5 transmitter/receiver modules, see page 38.

Applications		Performance distributed I/O (IP 20)	Performance distributed I/O (IP 67)
Compatibility		<ul style="list-style-type: none"> <li>■ Modicon M258 logic controller</li> <li>■ Modicon LMC058 Motion controller</li> </ul>	
			
Available buses and networks		■ CANopen bus	■ CANopen bus
Configuration with I/O expansion modules	Module type	<b>Modicon TM5 modules and/or Modicon TM7 blocks:</b> <ul style="list-style-type: none"> <li><input type="checkbox"/> Digital I/O modules</li> <li><input type="checkbox"/> Analog I/O modules</li> <li><input type="checkbox"/> Common distribution modules (TM5 only)</li> </ul>	<b>Modicon TM5 modules and/or Modicon TM7 blocks:</b> <ul style="list-style-type: none"> <li><input type="checkbox"/> Digital I/O modules</li> <li><input type="checkbox"/> Analog I/O modules</li> <li><input type="checkbox"/> Common distribution modules (TM5 only)</li> </ul>
	Capacity	For 1 Modicon TM5 interface module: 40 TM5/TM7 modules max. Including: <ul style="list-style-type: none"> <li><input type="checkbox"/> Digital I/O modules: 240 inputs and 240 outputs max.</li> <li><input type="checkbox"/> Analog I/O modules: 20 inputs and 20 outputs</li> </ul> Maximum distance from the expansion bus (TM5 or TM7): 2500 m. Maximum distance between 2 islands of TM5 modules: 100 m. Maximum distance between 2 TM7 blocks: 100 m. Maximum distance between 1 island of TM5 modules and 1 TM7 block: 100 m.	For 1 TM7 CANopen interface block: 40 TM5/TM7 modules max. Including: <ul style="list-style-type: none"> <li><input type="checkbox"/> Digital I/O modules: 240 inputs and 240 outputs max.</li> <li><input type="checkbox"/> Analog I/O modules: 20 inputs and 20 outputs</li> </ul> Maximum distance from the expansion bus (TM5 or TM7): 2500 m. Maximum distance between 2 islands of TM5 modules: 100 m. Maximum distance between 2 TM7 blocks: 100 m. Maximum distance between 1 island of TM5 modules and 1 TM7 block: 100 m.
Integrated I/O	Number and type (depending on model)	–	8 to 16 digital channels that can be configured as inputs (24 V $\overline{\text{---}}$ ) or outputs (24 V $\overline{\text{---}}$ )
Type of distributed I/O expansion module		Modicon TM5 CANopen interface module	Modicon TM7 CANopen interface blocks
Page		58	62



<b>Applications</b>	Modicon TM5 compact block
	Compatibility

<b>20 I/O</b>	<b>36 I/O</b>	<b>42 I/O</b>
Modicon M258 logic controller		
Modicon LMC058 Motion controller		

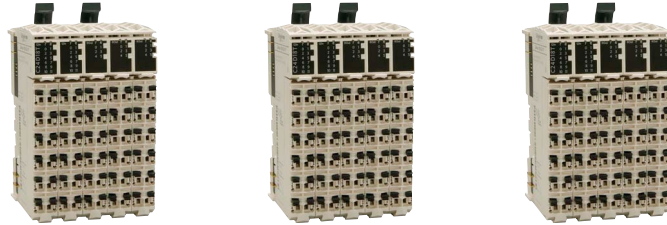

**Channel connection**

With removable spring terminal blocks (supplied)

<b>Digital inputs</b>	Number
	Nominal input voltage
	IEC/EN 61131-2 conformity
	Type of signal (1)
	Type of wiring
	Limit values
	Nominal input current
	Input impedance
	State 0
	State 1

<b>12</b>	<b>24</b>	<b>24</b>
24 V ---	24 V ---	24 V ---
Type 1	Type 1	Type 1
Sink	Sink	Sink
3-wire	1-wire	1-wire
20.4... 28.8 V ---	20.4... 28.8 V ---	20.4... 28.8 V ---
3.75 mA	3.75 mA	3.75 mA
6.4 kΩ	6.4 kΩ	6.4 kΩ
5 V max. ---	5 V max. ---	5 V max. ---
15 V min. ---	15 V min. ---	15 V min. ---

<b>Digital outputs</b>	Number
	Nominal output voltage
	Output current per channel
	Output current per group of channels
	Type of signal (1)
	Type of wiring
	Limit values
	Short-circuit and overload protection

<b>8, transistor</b>	<b>12, relays with NO contact</b>	<b>18, transistor</b>
24 V ---	24 V ---	24 V ---
0.5 A	0.5 A	0.5 A
1 A max.	5 A max.	2 A max.
Source	Source	Source
3-wire	1-, 2- or 3-wire	2-wire
20.4...28.8 V ---	20.4...28.8 V ---	20.4...28.8 V ---
Yes	Yes	Yes

<b>Analog inputs</b>	Number
	Type
	Range
	Resolution
	Sampling period
	without filtering
	with filtering

<b>Analog outputs</b>	Number
	Type
	Range
	Resolution
	Response time

<b>Power supply</b>	
<b>Isolation</b>	Channel-to-channel
	Between channel groups
	Channel-to-bus

<b>Type of Modicon TM5 compact block</b>	
--	--

<b>TM5 C12D8T</b>	<b>TM5 C24D12R</b>	<b>TM5 C24D18T</b>
-------------------	--------------------	--------------------

<b>Page</b>	
-------------	--

19	19	19
----	----	----

(1) Source output: PNP output. Sink output: NPN output.



24 I/O

16 I/O

Modicon M258 logic controller  
Modicon LMC058 Motion controller

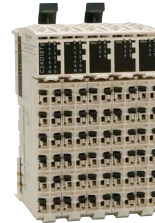
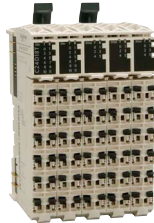
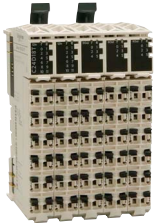

With removable spring terminal blocks (supplied)

12

24 V  $\overline{\text{---}}$ 

Type 1

Sink

2-wire

20.4... 28.8 V  $\overline{\text{---}}$ 

3.75 mA

6.4 k $\Omega$ 5 V max.  $\overline{\text{---}}$ 15 V min.  $\overline{\text{---}}$ 

6, transistor

24 V  $\overline{\text{---}}$ 

0.5 A

2 A max.

Source

2-wire

20.4... 28.8 V  $\overline{\text{---}}$ 

Yes

<b>4</b>	<b>8</b>	<b>8</b>	<b>8</b>
Voltage/current	Voltage	Current	<b>4</b> Voltage + <b>4</b> current
- 10... + 10 Vdc 0...20 mA/4...20 mA	- 10... + 10 Vdc	0...20 mA/4...20 mA	Voltage : - 10... + 10 Vdc Current : 0...20 mA/4...20 mA
12 bits	11 bits + sign	12 bits	Voltage: 11 bits + sign Current: 12 bits
300 $\mu$ s	–	–	–
1 ms	50 ms	50 ms	50 ms
<b>2</b>	<b>8</b>	<b>8</b>	<b>8</b>
Voltage/current	Voltage	Current	<b>4</b> Voltage + <b>4</b> current
- 10... + 10 Vdc 0...20 mA	- 10... + 10 Vdc	0...20 mA	Voltage : - 10... + 10 Vdc Current : 0...20 mA
12 bits	11 bits + sign	12 bits	Voltage: 11 bits + sign Current: 12 bits
1 ms max.	20 ms max. 5 ms per channel	20 ms max. 5 ms per channel	20 ms max. 5 ms per channel
Internal	Internal	Internal	Internal
Non-isolated	Non-isolated	Non-isolated	Non-isolated
–	–	–	–
500 V $\sim$ RMS	500 V $\sim$ RMS	500 V $\sim$ RMS	500 V $\sim$ RMS
<b>TM5 C12D6T6L</b>	<b>TM5 CAI8O8VL</b>	<b>TM5 CAI8O8CL</b>	<b>TM5 CAI8O8CVL</b>
19	19	19	19

#### Presentation

Modicon TM5 compact blocks offer a low-cost solution for expanding digital and/or analogue I/O control system configurations.

They consist of a block containing the circuit boards, the bus bases, and the TM5ACTB12 removable terminal blocks.

They complement the embedded I/O in the various LMC058 motion controllers and represent a cost-effective way to create configurations requiring a large number of digital or analogue channels.

The TM5 C●●●●●● I/O compact block offer consists of:

- A 24 V  $\overline{\text{V}}$  digital I/O compact block, with 12 sink inputs and 8 transistor outputs
- A 24 V  $\overline{\text{V}}$  digital I/O compact block, with 24 sink inputs and 12 relay outputs
- A 24 V  $\overline{\text{V}}$  digital I/O compact block, with 24 sink inputs and 18 transistor outputs
- A 24 V  $\overline{\text{V}}$  mixed I/O compact block, with 12 sink digital inputs and 4 analogue inputs, and 6 transistor digital outputs and 2 analogue outputs
- 3 x 24 V  $\overline{\text{V}}$  analogue I/O compact block:
  - a block with 8 voltage I/O
  - a block with 8 current I/O
  - a block with 4 voltage I/O + 4 current I/O.

Regardless of which compact block is chosen, the format is the same and corresponds to five I/O expansion modules.

TM5 compact blocks are connected to the TM5 expansion bus on LMC058 motion controllers.

The advantage of these blocks is their compact size, ease of wiring and, depending on the reference, the option of combining different types of channel.

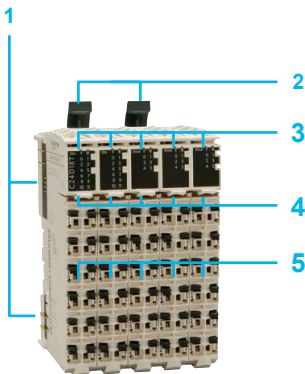

#### Description

TM5 compact blocks comprise:

- 1 On each side of the base, a bus expansion connection for the link with the previous controller or block
- 2 Two mechanical locking clips for mounting/dismounting on a symmetrical rail
- 3 Five LED display blocks for the channels and compact block diagnostics
- 4 Five slots for the plain text cover holder (label-holder)
- 5 Five removable spring terminal blocks, each with locking clip and slots for coloured identifiers



# Modicon LMC058 Motion controller

## I/O expansion modules

### Modicon TM5 compact blocks

Device colour: white

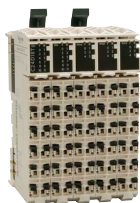

TM5C12D8T



TM5C24D12R

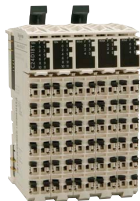

TM5C24D18T

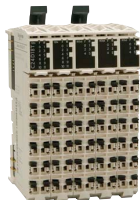

TM5C12D6T6L



TM5CAI8O8VL



TM5CAI8O8CL



TM5CAI8O8CVL



TM5ACTB●●



TM5ACTLC100



TM5ACTCH100



TM5ACLT1

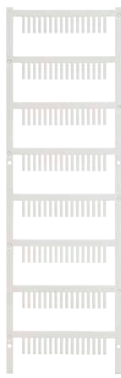

TM5ACLITW1

#### References

Number of I/O	Inputs	Outputs (1)	Reference	Weight kg lb
<b>TM5 I/O digital compact blocks</b>				
20 I/O	12 digital inputs, 24 V $\overline{\text{---}}$ , Sink, 3-wire	8 transistor digital outputs, 3-wire, 24 V $\overline{\text{---}}$ , Source, 0.5 A	TM5C12D8T	0.037 0.082
36 I/O	24 digital inputs, 24 V $\overline{\text{---}}$ , Sink, 1-wire, 0.5 A max	12 digital outputs, 5 A relay, with NO contact, 30 V $\overline{\text{---}}$ /230 V $\sim$	TM5C24D12R	0.037 0.082
42 I/O	24 digital inputs, 24 V $\overline{\text{---}}$ , Sink, 1-wire	18 transistor digital outputs, 24 V $\overline{\text{---}}$ , Source, 0.5 A, 2-wire	TM5C24D18T	0.037 0.082

#### TM5 I/O digital/analogue compact blocks

24 I/O	12 digital inputs, 24 V $\overline{\text{---}}$ , Sink, 2-wire  4 analogue inputs - 10...+ 10 V, 0...20 mA, 4...20 mA, resolution 12 bits	6 transistor digital outputs, 2-wire, 24 V $\overline{\text{---}}$ , Source, 0.5 A  2 analogue outputs, - 10...+ 10 V, 0...20 mA, resolution 12 bits	TM5C12D6T6L	0.037 0.082
--------	--	---	-------------	----------------

#### TM5 I/O analogue compact blocks

16 I/O	8 analogue voltage inputs - 10...+ 10 Vdc Resolution 11 bits + sign	8 analogue voltage outputs - 10...+ 10 Vdc Resolution 11 bits + sign	TM5CAI8O8VL	0.037 0.082
	8 analogue current inputs 0...20 mA/4...20 mA Resolution 12 bits	8 analogue current outputs 0...20 mA Resolution 12 bits	TM5CAI8O8CL	0.037 0.082
	8 analogue inputs: <input type="checkbox"/> 4 voltage inputs - 10...+ 10 Vdc <input type="checkbox"/> 4 current inputs 0...20 mA/4...20 mA Resolution <input type="checkbox"/> voltage: 11 bits + sign <input type="checkbox"/> current : 12 bits	8 analogue outputs: <input type="checkbox"/> 4 voltage outputs - 10...+ 10 Vdc <input type="checkbox"/> + 4 current outputs 0...20 mA Resolution <input type="checkbox"/> voltage: 11 bits + sign <input type="checkbox"/> current : 12 bits	TM5CAI8O8CVL	0.037 0.082

#### Terminal blocks

Use	Description	Sold in lots of	Unit reference	Weight kg lb
For I/O compact blocks, 24 V $\overline{\text{---}}$ power supply	12 spring terminals	1	TM5ACTB12	0.020 0.044
		10	TM5ACTB1210	0.200 0.441

#### Accessories

Description	Used for	Colour	Sold in lots of	Unit reference	Weight kg lb
Plain text cover holder (label-holder)	Marking the terminal blocks on the I/O channels	Transparent	100	TM5ACTCH100	0.200 0.441
Plain text cover holder locking clip (Order with plain text cover holder TM5ACTCH100)	Locking plain text cover holder	Transparent	100	TM5ACTLC100	0.100 0.220
Precut legend strips of paper	Plain text cover holder	White	100	TM5ACTLS100	0.100 0.220
Coloured plastic identifiers	Labelling 16 connection channel terminals	White	1	TM5ACLITW1	0.015
		Red	1	TM5ACLITR1	0.033
		Blue	1	TM5ACLITB1	
Metal tool	Inserting/removing TM5 ACLIT*1 identifiers	Black	1	TM5ACLT1	0.030 0.066

(1) Source output: PNP output, sink output: NPN output.

**Applications** Type of expansion module

Compatibility

**2 to 12 digital input channels**

Modicon M258 logic controller, Modicon LMC058 motion controller



**Channel connection**

**Digital inputs**

Number

Nominal input voltage

IEC/EN 61131-2 conformity

Type of signal (1)

Type of wiring

Limit values

Nominal input current

Input impedance

State 0

State 1

With removable spring terminal blocks (to be ordered separately)

2	4	6	12	2	4	6
24 V $\overline{\text{DC}}$				100/240 V $\sim$		
Type 1				Type 1		
Sink						
1-, 2- or 3-wire		1 or 2-wire	1-wire	1-, 2- or 3-wire	1 or 2-wire	
$\overline{\text{DC}}$ 20.4... 28.8 V				$\sim$ 100... 240 V		
3.75 mA				5 mA at $\sim$ 100 V		10 mA at $\sim$ 120 V
6.4 k $\Omega$				-		
$\overline{\text{DC}}$ 5 V max.				-		
$\overline{\text{DC}}$ 15 V min.				-		

**Digital outputs**

Number

Nominal output voltage

Output current per channel

Output current per group of channels

Type of signal (1)

Type of wiring

Limit values

Short-circuit and overload protection

**Analog inputs**

Number

Type

Range

Resolution

Sampling period

without filtering

with filtering

**Analog outputs**

Number

Type

Range

Resolution

Response time

**Type of electronic expansion module**

TM5 SDI2D	TM5 SDI4D	TM5 SDI6D	TM5 SDI12D	TM5 SDI2A	TM5 SDI4A	TM5 SDI6U
-----------	-----------	-----------	------------	-----------	-----------	-----------

**Associated bus base (2)**

TM5 ACBM11, TM5 ACBM15	TM5 ACBM12
------------------------	------------

**Associated terminal block (2)**

TM5 ACTB06, TM5 ACTB12	TM5ACTB12	TM5 ACTB32
------------------------	-----------	------------

**Pages**

23	25
----	----

(1) Source output: PNP output, sink output: NPN output.  
 (2) to be ordered separately.



4 digital input channels and 1 analog input channel 2 digital output channels and 1 analog output channel	8 digital input channels 4 transistor output channels	2 to 12 transistor output channels					2 transistor output channels	2 to 4 relay output channels
--	--	------------------------------------	--	--	--	--	------------------------------	------------------------------

**Modicon M258 logic controller, Modicon LMC058 motion controller**



With removable spring terminal blocks (to be ordered separately)

<b>4</b>	<b>8</b>
24 V $\overline{\text{---}}$	24 V $\overline{\text{---}}$
Type 1	Type 1
Sink	Sink
1-wire	1-wire
$\overline{\text{---}}$ 20.4...28.8 V	$\overline{\text{---}}$ 20.4...28.8 V
3.3 mA	3.75 mA
7.2 k $\Omega$	6.4 k $\Omega$
$\overline{\text{---}}$ 5 V max.	$\overline{\text{---}}$ 5 V max.
$\overline{\text{---}}$ 15 V min.	$\overline{\text{---}}$ 15 V min.

<b>2</b>	<b>4</b>	<b>2</b>	<b>4</b>	<b>4</b>	<b>6</b>	<b>8</b>	<b>12</b>	<b>2</b>	<b>2</b>	<b>4</b>
24 V $\overline{\text{---}}$	24 V $\overline{\text{---}}$	24 V $\overline{\text{---}}$					100/240 V $\sim$			$\overline{\text{---}}$ 30/ $\sim$ 230 V
0.5 A	0.5 A	0.5 A	0.5 A	2 A	0.5 A	2 A	0.5 A	1 A	5 A	10 A max.
1 A max.	2 A max.	1 A max.	2 A max.	4 A max.	3 A max.	8 A max.	6 A max.	1 A	Relay	
Source	Source	Source					Solid state relay			Relay
1-wire	1-wire	1-, 2- or 3-wire				1 or 2-wire	1-wire	3-wire	NO/NC contact	
$\overline{\text{---}}$ 20, 4...28.8 V	$\overline{\text{---}}$ 20.4...28.8 V	$\overline{\text{---}}$ 20.4...28.8 V					$\sim$ 80...264 V			$\overline{\text{---}}$ 24...36 V $\sim$ 184...276 V
Yes	Yes	Yes					Yes			No

<b>1</b>
Voltage/current
- 10...+ 10 Vdc
0...20 mA/4...20 mA
12 bits + sign
400 ms
1 ms max.

<b>1</b>
Voltage/current
- 10...+ 10 Vdc
0...20 mA
12 bits
1 ms max.

TM5 SMM6D2L	TM5 SDM12DT	TM5 SDO2T	TM5 SDO4T	TM5 SDO4TA	TM5 SDO6T	TM5 SDO8TA	TM5 SDO12T	TM5 SDO2S	TM5 SDO2R	TM5 SDO4R TM5 SDO4R4
-------------	-------------	-----------	-----------	------------	-----------	------------	------------	-----------	-----------	-------------------------

TM5 ACBM11, TM5 ACBM15	TM5 ACBM12
------------------------	------------

TM5 ACTB12	TM5 ACTB06, TM5 ACTB12	TM5 ACTB12	TM5 ACTB32
------------	------------------------	------------	------------

23	25
----	----



More technical information on [www.schneider-electric.com](http://www.schneider-electric.com)

#### Presentation

The TM5 S●●●● digital module offer consists of:

- Eleven input, mixed I/O and output electronic modules (sensor and preactuator 24 V  $\overline{\text{V}}$  power supply): TM5 SD●●●
- One Digital/Analog mixed I/O electronic module: **TM5 SMM6D2L**.

They complement the embedded I/O in the various LMC058 motion controllers. They are used to adapt to the application requirements as closely as possible to reduce the installation and wiring costs.

Each digital expansion module consists of three parts to be ordered separately (1):

- An I/O electronic module
- A bus base
- A terminal block

These modules can be mechanically assembled before mounting on a symmetrical rail.

These modules offer the following advantages:

- Removable terminal
- Spring terminals which can be used for quick, tool-free connection of the sensors and preactuators in addition, the quality of the spring terminals avoids the need for periodic retightening
- Hot swapping

The digital modules offer includes:

- Four 24 V  $\overline{\text{V}}$  digital input modules with 2, 4, 6 or 12 sink inputs
- One 24 V  $\overline{\text{V}}$  digital mixed I/O electronic module, with 8 sink inputs and 4 source transistor outputs
- Six digital output electronic modules with 2, 4, 6 or 12 source transistor outputs

The digital/analog module offer includes:

- one mixed I/O electronic module with four 24 V  $\overline{\text{V}}$  digital inputs and one voltage/current analog input, two 24 V digital outputs and one voltage/current analog output.

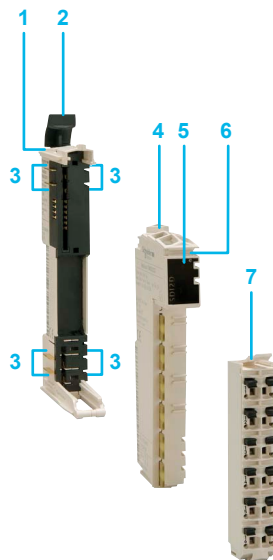

#### Description

TM5 SD●●●● digital modules and digital/analog TM5 SMM6D2L module comprise:

- 1 A bus base
- 2 A mechanical locking lever for mounting/dismounting on a symmetrical rail
- 3 On each side of the base, a bus expansion connection for the link with the previous controller or module
- 4 A digital input, I/O or output electronic module
- 5 A channel and module diagnostics LED display block
- 6 A slot for labelling (label-holder)
- 7 A removable spring terminal block with locking lever and slots for coloured identifiers

(1) Also sold in kits, see page 23

# Modicon LMC058 Motion controller

## I/O expansion modules

### Modicon TM5 Digital modules

### and Modicon TM5 Digital/Analog module

Device colour: White



TM5 SD●●●

TM5 SMM6D2L



TM5 ACBM●●

TM5 ACTB●●

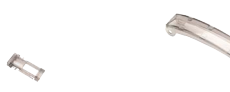

TM5 ACTLC100

TM5 ACTCH100



TM5 ACLPL10

TM5 ACLPR10



TM5 SD●12DK

## References

### Digital input electronic modules

Voltage	Number and type of channels (1)	Reference	Weight kg
24 V $\overline{\text{---}}$ inputs	2 sink inputs	TM5 SDI2D	0.025
	4 sink inputs	TM5 SDI4D	0.025
	6 sink inputs	TM5 SDI6D	0.025
	12 sink inputs	TM5 SDI12D	0.025

### Digital mixed inputs/outputs electronic modules

24 V $\overline{\text{---}}$ inputs/outputs	8 sink inputs, 4 source transistor outputs	TM5 SDM12DT	0.025
--	--	-------------	-------

### Digital output electronic modules

24 V $\overline{\text{---}}$ outputs	2 source transistor outputs	0.5 A per channel	TM5 SDO2T	0.025
	4 source transistor outputs	0.5 A per channel	TM5 SDO4T	0.025
	4 source transistor outputs	2 A per channel, 4 A per module	TM5 SDO4TA	0.025
	6 source transistor outputs	0.5 A per channel	TM5 SDO6T	0.025
	8 source transistor outputs	2 A per channel	TM5 SDO8TA	0.025
	12 source transistor outputs	0.5 A per channel	TM5 SDO12T	0.025

### Digital/Analog mixed inputs/outputs electronic module

24 V $\overline{\text{---}}$ inputs/outputs	4 sink digital inputs	–	TM5 SMM6D2L	0,025
	1 analog input	- 10...+ 10Vdc, 0...20 mA/4...20 mA		
	2 source transistor outputs	0.5 A per channel		
	1 analog output	0...20 mA		

### Bus bases

Power supply	Characteristics	Sold in lots of	Unit reference	Weight kg
24 V $\overline{\text{---}}$	–	1	TM5 ACBM11	0.020
		10	TM5 ACBM1110	0.020
	Address setting	1	TM5 ACBM15	0.020
		10	TM5 ACBM1510	0.020

### Terminal blocks

Use	Description	Sold in lots of	Unit reference	Weight kg
For electronic modules, 24 V $\overline{\text{---}}$ power supply	6 contacts	1	TM5 ACTB06	0.016
		10	TM5 ACTB0610	0.016
	12 contacts	1	TM5 ACTB12	0.020
		10	TM5 ACTB1210	0.020

### Accessories

Description	Used for	Colour	Sold in lots of	Unit reference	Weight kg
Plain text cover holder (label-holder)	Marking the terminal blocks on the I/O channels	Transparent	100	TM5 ACTCH100	0.002
Plain text cover holder locking clip (Order with plain text cover holder TM5 ACTCH100)	Locking plain text cover holder TM5 ACTCH100	Transparent	100	TM5 ACTLC100	0.001
Precut legend strips of paper	Plain text cover holder TM5 ACTCH100	White	100	TM5 ACTLS100	0.001
Coloured plastic identifiers	Labelling 16 connection channel terminals	White	1	TM5 ACLITW1	0.015
		Red	1	TM5 ACLITR1	0.015
		Blue	1	TM5 ACLITB1	0.015
Metal tool	Inserting/removing TM5 ACLIT●1 identifiers	Black	1	TM5 ACLT1	0.030
Retaining plates for bus bases	Held on the left side	White	10	TM5 ACLPL10	0.004
	Held on the right side	White	10	TM5 ACLPR10	0.004
Locking clips	For modules	Black	100	TM5 ACADL100	0.001

### Digital I/O expansion module kits

Description	Composition	Reference	Weight kg
Kit including a digital input or output electronic module, a bus base and a terminal block	TM5 SDI12D + TM5 ACBM11 + TM5 ACTB12	TM5 SDI12DK	0.065
	TM5 SDO12T + TM5 ACBM11 + TM5 ACTB12	TM5 SDO12TK	0.065

(1) Source output: PNP output, sink output: NPN output.

#### Presentation

The **TM5 SD●●●** digital module offer consists of six input and output electronic modules (sensor and preactuator 100/240 V ~ power supply). They complement the embedded I/O in the various LMC058 motion controllers. They are used to adapt to the application requirements as closely as possible to reduce the installation and wiring costs.

Each digital module consists of three parts to be ordered separately (1):

- An I/O electronic module
- A bus base
- A terminal block

These modules can be mechanically assembled before mounting on a symmetrical rail.

These modules offer the following advantages:

- Removable terminal
- Spring terminals which can be used for quick, tool-free connection of the sensors and preactuators in addition, the quality of the spring terminals avoids the need for periodic retightening
- Hot swapping

The digital modules offer includes:

- Two 100/240 V ~ digital input electronic modules, with 2 or 4 inputs
- A 100/120 V ~ digital input electronic module, with 6 inputs
- A 100/240 V ~ digital output electronic modules, with 2 outputs
- Two 30 V ~/230 V ~ digital output electronic modules, with 2 or 4 relay outputs

#### Description

**TM5 SD●●●** digital modules comprise:

- 1 A bus base
- 2 A mechanical locking lever for mounting/dismounting on a symmetrical rail
- 3 On each side of the base, a bus expansion connection for the link with the previous controller or module
- 4 A digital input or output electronic module
- 5 A channel and module diagnostics LED display block
- 6 A slot for labelling (label-holder)
- 7 A removable spring terminal block with locking lever and slots for coloured identifiers

(1) Also sold in kit, see page 23

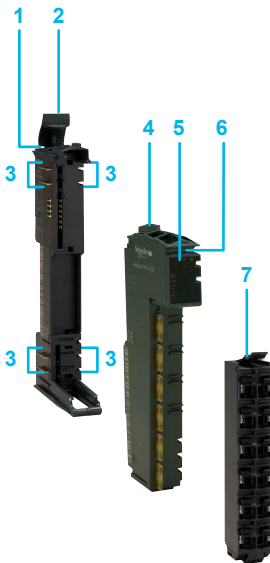

Device colour: black



TM5 SDI●●



TM5 SDO●●



TM5 ACBM●●



TM5 ACTB●●



TM5 ACTLC100



TM5 ACTCH100



TM5 ACLPL10



TM5 ACLPR10



TM5 SDO4RK

## References

### Multivoltage digital input electronic modules

Voltage	Number and type of channels (1)	Sold in lots of	Unit reference	Weight kg
100/240 V ~ inputs	2 inputs	1	TM5 SDI2A	0.025
	4 inputs	1	TM5 SDI4A	0.025

100/120 V ~ inputs	6 inputs	1	TM5 SDI6U	0.025
-----------------------	----------	---	-----------	-------

### Digital output electronic modules

100/240 V ~ outputs	2 x 1 A transistor outputs	1	TM5 SDO2S	0.025
30 V ---/230 V ~ outputs	2 x 5 A relay outputs, NO/NC contact	1	TM5 SDO2R	0.025
	4 x 5 A relay outputs, NO/NC contact	1	TM5 SDO4R	0.025
		4	TM5 SDO4R4	0.100

### Bus bases

Power supply	Characteristics	Sold in lots of	Unit reference	Weight kg
~ 240 V	-	1	TM5 ACBM12	0.020
		10	TM5 ACBM1210	0.020

### Terminal blocks

Use	Description	Sold in lots of	Unit reference	Weight kg
For digital I/O electronic module, 240 V ~ power supply	12 contacts	1	TM5 ACTB32	0.025
		10	TM5 ACTB3210	0.025

### Accessories

Description	Used for	Colour	Sold in lots of	Unit reference	Weight kg
Plain text cover holder (label-holder)	Marking the terminal blocks on the I/O channels	Transparent	100	TM5 ACTCH100	0.002
Plain text cover holder locking clip (Order with plain text cover holder TM5 ACTCH100)	Locking plain text cover holder TM5 ACTCH100	Transparent	100	TM5 ACTLC100	0.001
Precut legend strips of paper	Plain text cover holder TM5 ACTCH100	White	100	TM5 ACTLS100	0.001
Coloured plastic identifiers	Labelling 16 connection channel terminals	White	1	TM5 ACLITW1	0.015
		Red	1	TM5 ACLITR1	0.015
		Blue	1	TM5 ACLITB1	0.015
Metal tool	Inserting/removing TM5 ACLIT●1 identifiers	Black	1	TM5 ACLT1	0.030
Retaining plates for bus bases	Held on the left side	White	10	TM5 ACLPL10	0.004
	Held on the right side	White	10	TM5 ACLPR10	0.004
Locking clips	For modules	Black	100	TM5 ACADL100	0.001

### Digital I/O expansion module kit

Description	Composition	Reference	Weight kg
Kit including a digital output electronic module, a bus base and a terminal block	TM5 SDO4R + TM5 ACBM12 + TM5 ACTB32	TM5 SDO4RK	0.070

(1) Source output: PNP output, sink output: NPN output.



#### Presentation

TM5 SP●●● common distribution modules make cabling more flexible by “branching” the various voltages needed to power the I/O expansion modules used.

Each common distribution module consists of three parts to be ordered separately:

- A common distribution electronic module
- A bus base
- A terminal block to be chosen according to the number of terminals

These modules can be mechanically assembled before mounting on a symmetrical rail.

These modules offer the following advantages:

- Removable terminal
- Spring terminals which can be used for quick, tool-free connection of the sensors and preactuators in addition, the quality of the spring terminals avoids the need for periodic retightening
- Hot swapping

The power supply common modules offer includes four common distribution electronic modules which have a removable fuse.

This offer is completed by a non-functioning dummy module TM5 SD000 which can be used to:

- Increase the flexibility in managing the various options for an installation: machine with or without temperature sensors for example.
- Reserve a physical slot and a logical address on the backplane bus, for adding a functioning module at a later date: application-specific I/O expansion for example.

#### Description

Common distribution modules comprise:

- 1 A bus base
- 2 A mechanical locking lever for mounting/dismounting on a symmetrical rail
- 3 On each side of the base, a bus expansion connection for the link with the previous controller or module
- 4 A common distribution electronic module
- 5 A channel and module diagnostics LED display block
- 6 A slot for labelling (label-holder)
- 7 A removable spring terminal block with locking lever and slots for coloured identifiers

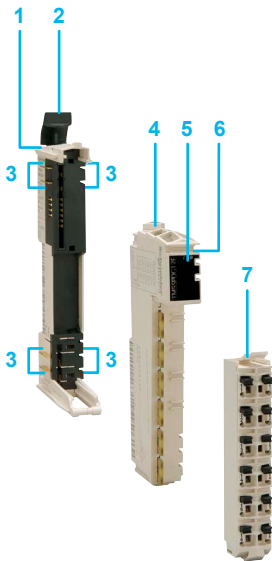



Device colour: white



TM5 SPDG●●●



TM5 ACBM●●



TM5 ACTB●●



TM5 ACTLC100



TM5 ACTCH100

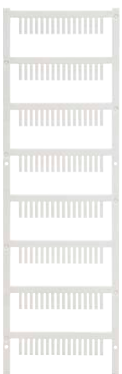

TM5 ACLITW1



TM5 ACLT1



TM5 ACLPL10



TM5 ACLPR10

## References

### Common distribution electronic modules (1)

Power supply type	Characteristics	Reference	Weight kg
24 V $\overline{\text{---}}$	12 common x 0 Vdc with 1 fuse	TM5 SPDG12F	0.025
	12 common x 24 Vdc with 1 fuse	TM5 SPDD12F	0.025
	5 common x 0 Vdc 5 common x 24 Vdc with 1 fuse	TM5 SPDG5D4F	0.025
	6 common x 0 Vdc 6 common x 24 Vdc with 1 fuse	TM5 SPDG6D6F	0.025

### Dummy electronic module

Characteristics	Used for	Reference	Weight kg
Non-functioning	Reservation of slots and logical address	TM5 SD000	0.015

### Bus bases

Power supply	Characteristics	Sold in lots of	Unit reference	Weight kg
24 V $\overline{\text{---}}$	–	1	TM5 ACBM11	0.020
		10	TM5 ACBM1110	0.020
	Address setting	1	TM5 ACBM15	0.020
		10	TM5 ACBM1510	0.020

### Terminal blocks

Use	Description	Sold in lots of	Unit reference	Weight kg
For common distribution electronic module, 24 V $\overline{\text{---}}$ power supply	6 contacts	1	TM5 ACTB06	0.016
		10	TM5 ACTB0610	0.016
	12 contacts	1	TM5 ACTB12	0.020
		10	TM5 ACTB1210	0.020

### Accessories

Description	Used for	Colour	Sold in lots of	Unit reference	Weight kg
Plain text cover holder (label-holder)	Marking the terminal blocks on the I/O channels	Transparent	100	TM5 ACTCH100	0.002
Plain text cover holder locking clip (Order with plain text cover holder TM5 ACTCH100)	Locking plain text cover holder	Transparent	100	TM5 ACTLC100	0.001
Precut legend strips of paper	Plain text cover holder TM5 ACTCH100	White	100	TM5 ACTLS100	0.001
Coloured plastic identifiers	Labelling 16 connection channel terminals	White	1	TM5 ACLITW1	0.015
		Red	1	TM5 ACLITR1	0.015
		Blue	1	TM5 ACLITB1	0.015
Metal tool	Inserting/removing TM5 ACLIT●1 identifiers	Black	1	TM5 ACLT1	0.030
Retaining plates for bus bases	Held on the left side	White	10	TM5 ACLPL10	0.004
	Held on the right side	White	10	TM5 ACLPR10	0.004
Locking clips	For modules	Black	100	TM5 ACADL100	0.001

(1) Equipped with 5 x 20 internal fuse, slow-blow 6.3 A

<b>Applications</b>	Type of expansion module
	Compatibility

<b>1 to 6 analog input channels</b>
<b>Modicon M258 logic controller, Modicon LMC058 motion controller</b>



<b>Channel connection</b>	
<b>Analog inputs</b>	Number
	Type
	Range
	Resolution
	Sampling period

With removable spring terminal blocks (to be ordered separately)					
<b>2</b>	<b>2</b>	<b>4</b>	<b>4</b>	<b>2</b>	<b>4</b>
Voltage/current				Pt100/Pt1000 temperature probe	
- 10...+ 10 Vdc 0...20 mA/ 4...20 mA	- 10...+ 10 Vdc 0...20 mA	- 10...+ 10 Vdc 0...20 mA/ 4...20 mA	- 10...+ 10 Vdc 0...20 mA	- 200...+ 850°C	
12 bits + sign	15 bits + sign	12 bits + sign	15 bits + sign	16 bits	
300 µs	–	400 µs	–	–	
1 ms	50 µs	1 ms	50 µs	–	

<b>Analog outputs</b>	Number
	Type
	Range
	Resolution
	Response time

<b>Digital inputs</b>	Number
	Nominal input voltage
	IEC/EN 61131-2 conformity
	Type of signal (1)
	Type of wiring
	Limit values
	Nominal input current
	Input impedance
	State 0
	State 1

<b>Digital outputs</b>	Number
	Nominal output voltage
	Output current per channel
	Output current per group of channels
	Type of signal (1)
	Type of wiring
	Limit values
	Short-circuit and overload protection

<b>Power supply</b>	
<b>Isolation</b>	Channel-to-channel
	Between channel groups
	Channel-to-bus

<b>Type of electronic module</b>
----------------------------------

<b>Associated bus base (2)</b>
--------------------------------

<b>Associated terminal block (2)</b>
--------------------------------------

<b>Page</b>
-------------

Internal
Non-isolated
–
~ 500 V RMS

<b>TM5 SAI2L</b>	<b>TM5 SAI2H</b>	<b>TM5 SAI4L</b>	<b>TM5 SAI4H</b>	<b>TM5 SAI2PH</b>	<b>TM5 SAI4PH</b>
<b>TM5 ACBM11, TM5 ACBM15</b>					
<b>TM5 ACTB06, TM5 ACTB12</b>		<b>TM5 ACTB12</b>		<b>TM5 ACTB06, TM5 ACTB12</b>	

31
----

(1) Source output: PNP output, sink output: NPN output.  
(2) to be ordered separately.



1 analog input channel  
and 4 digital input  
channels  
1 analog input channel  
and 2 digital output  
channels

2 to 4 analog output channels



With removable spring terminal blocks (to be ordered separately)

2	6	1	1
J, K, S, N thermocouple	Full bridge Strain Gauge	Voltage/current	
Type J: - 210...+ 1200°C Type K: - 270...+ 1372°C Type S: - 50...+ 1768°C Type N: - 270...+ 1300°C	Differential: 85...5000 Ω	- 10...+ 10 Vdc 0...20 mA/4...20 mA	
16 bits	24 bits	12 bits + sign	
-	-	400 ms	
-	-	1 ms max.	

1	2	2	4	4
Voltage/current	Voltage/current			
- 10...+ 10 Vdc 0...20 mA	- 10...+ 10 Vdc 0...20 mA			
12 bits	12 bits + sign			
1 ms maxi	1 ms max.			

4
24 V $\bar{\bar{}}$
Type 1
Sink
1-wire
$\bar{\bar{}}$ 20.4...28.8 V
3.3 mA
7.2 kΩ
$\bar{\bar{}}$ 5 V max.
$\bar{\bar{}}$ 15 V min.

2
24 V $\bar{\bar{}}$
0.5 A
1 A max.
Source
1-wire
$\bar{\bar{}}$ 20.4...28.8 V
Yes

Internal	Internal	Internal	Internal
Non-isolated	Non-isolated	Non-isolated	Non-isolated
-	-	-	-
~ 500 V RMS	~ 500 V RMS	~ 500 V RMS	~ 500 V RMS

TM5 SAI2TH	TM5 SAI6TH	TM5 SEAISG	TM5 SMM6D2L	TM5 SAO2L	TM5 SAO2H	TM5 SAO4L	TM5 SAO4H
------------	------------	------------	-------------	-----------	-----------	-----------	-----------

TM5 ACBM11, TM5 ACBM15
------------------------

TM5 ACTB06, TM5 ACTB12	TM5 ACTB12	TM5 ACTB06, TM5 ACTB12	TM5 ACTB12
------------------------	------------	------------------------	------------

31	23	31
----	----	----

#### Presentation

TM5 SAI●● and TM5 SEIAISG analog modules are used to acquire various analog values encountered in industrial applications.

TM5 SAO●●● Analog output modules are used to control preactuators in physical units, such as variable speed drives or valves and applications where process control is required. The output current or voltage is proportional to the numerical value defined by the user program.

On a controller "stop", the outputs can be configured with fallback (set to the bottom scale value or held at their value). This function, with holding the value, is used when debugging the application or on a fault so as not to disturb the controlled process.

Each analog module consists of three parts to be ordered separately (1):

- An I/O electronic module
- A bus base
- A terminal block

These modules can be mechanically assembled before mounting on a symmetrical rail.

These modules offer the following advantages:

- Removable terminal
- Spring terminals which can be used for quick, tool-free connection of the sensors and preactuators in addition, the quality of the spring terminals avoids the need for periodic retightening
- Hot swapping

The offer of 13 analog modules:

- Four electronic modules with 2 or 4 voltage/current inputs
- Two electronic modules with 2 or 4 Pt100/Pt1000 temperature probes
- Two electronic modules with 2 or 6 J, K, S and N thermocouple inputs
- One electronic module with 1 Full-bridge strain gauge input
- Four electronic modules with 2 or 4 voltage/current outputs

Depending on the application requirements, these electronic modules are available in 12, 16 or 24 bit-resolution.

It is advisable to use the TM2XMTGB earthing plate which simplifies connection of the analog sensor and actuator cable shielding. This shielding must be connected to the device's functional earth.

#### Description

Analog modules comprise:

- 1 A bus base
- 2 A mechanical locking lever for mounting/dismounting on a symmetrical rail
- 3 On each side of the base, a bus expansion connection for the link with the previous controller or module
- 4 An analog input or output electronic module
- 5 A channel and module diagnostics LED display block
- 6 A slot for labelling (label-holder)
- 7 A removable spring terminal block with locking lever and slots for coloured identifiers

(1) Also sold in kits, see page 31

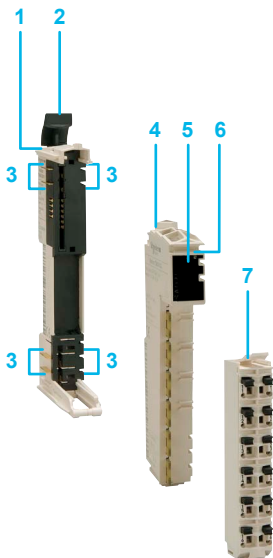

Device colour: white



TM5 SAI●● TM5 SAO●● TM5 SAO●●



TM5 ACBM●● TM5 ACTB●●



TM5 ACTLC100 TM5 ACTCH100



TM5 ACLPL10 TM5 ACLPR10



TM2 XMTGB TM200 RSRCEMC

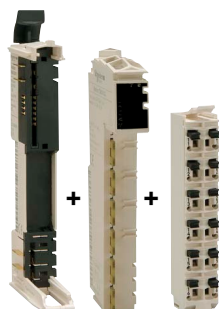

TM5 SA●4●K

### References

#### Analog input electronic modules

Number and type of inputs	Input range	Resolution	Reference	Weight kg
2 voltage/current inputs	- 10...+ 10 V DC, 0...20 mA/4...20 mA	12 bits + sign	TM5 SAI2L	0.025
	- 10...+ 10 V DC, 0...20 mA	15 bits + sign	TM5 SAI2H	0.025
4 voltage/current inputs	- 10...+ 10 Vdc, 0...20 mA/ 4...20 mA	12 bits + sign	TM5 SAI4L	0.025
	- 10...+ 10 V DC, 0...20 mA	15 bits + sign	TM5 SAI4H	0.025
2 Pt100/Pt1000 temperature probe inputs	- 200...+ 850°C	16 bits	TM5 SAI2PH	0.025
4 Pt100/Pt1000 temperature probe inputs		16 bits	TM5 SAI4PH	0.025
2 J, K, S, N thermocouple inputs	Type J: - 210...+ 1200°C	16 bits	TM5 SAI2TH	0.025
6 J, K, S, N thermocouple inputs	Type K: - 270...+ 1372°C	16 bits	TM5 SAI6TH	0.025
	Type S: - 50...+ 1768°C			
	Type N: - 270...+ 1300°C			

#### 1 Full bridge strain gauge input

Differential: 85...5000 Ω 24 bits TM5 SEAISG 0.025

#### Analog output electronic modules

Nber and type of O	Output range	Resolution	Reference	Weight kg
2 voltage/current outputs	- 10...+ 10 V DC, 0...20 mA	12 bits + sign	TM5 SAO2L	0.025
		15 bits + sign	TM5 SAO2H	0.025
4 voltage/current outputs	- 10...+ 10 V DC, 0...20 mA	12 bits + sign	TM5 SAO4L	0.025
		15 bits + sign	TM5 SAO4H	0.025

#### Bus bases

Power supply	Characteristics	Sold in lots of	Unit reference	Weight kg
24 V $\overline{\text{---}}$	-	1	TM5 ACBM11	0.020
		10	TM5 ACBM1110	0.020
	Address setting	1	TM5 ACBM15	0.020
		10	TM5 ACBM1510	0.020

#### Terminal blocks

Use	Type	Sold in lots of	Unit reference	Weight kg
For analog I/O electronic module, 24 V $\overline{\text{---}}$ power supply	6 contacts	1	TM5 ACTB06	0.016
		10	TM5 ACTB0610	0.016
	12 contacts	1	TM5 ACTB12	0.020
		10	TM5 ACTB1210	0.020

#### Accessories

Designation	Used for	Colour	Sold in lots of	Unit reference	Weight kg
Plain text cover holder (label-holder)	Marking the terminal blocks on the I/O channels	Transparent	100	TM5 ACTCH100	0.002
Plain text cover holder locking clip <i>(Order with plain text cover holder TM5 ACTCH100)</i>	Locking plain text cover holder TM5 ACTCH100	Transparent	100	TM5 ACTLC100	0.001
Precut legend strips of paper	Plain text cover holder TM5 ACTCH100	White	100	TM5 ACTLS100	0.001
Coloured plastic identifiers	Labelling 16 connection channel terminals	White	1	TM5 ACLITW1	0.015
		Red	1	TM5 ACLITR1	0.015
		Blue	1	TM5 ACLITB1	0.015
Metal tool	Inserting/removing TM5 ACLIT●1 identifiers	Black	1	TM5 ACLT1	0.030
Retaining plates for bus bases	Held on the left side	White	10	TM5 ACLPL10	0.004
	Held on the right side	White	10	TM5 ACLPR10	0.004
Locking clips	For modules	Black	100	TM5 ACADL100	0.001

#### Separate parts

Designation	Description	Unit reference	Weight kg
Earthing plate	Support equipped with 10 male Faston connectors for connecting the cable shielding (via 6.35 mm connectors, not supplied) and the functional earths (FE)	TM2 XMTGB	0.045
Shielding connection clamps <i>Sold in lots of 25</i>	Attachment and earthing of the cable shielding. Pack of 25 clamps including 20 for Ø 4.8 mm cable and 5 for Ø 7.9 mm cable	TM200 RSRCEMC	-
Mounting kit <i>(Sold in lots of 5)</i>	For mounting the analog modules on a plate or panel	TWD XMT 5	0.065

#### Analog I/O expansion module kits

Designation	Description	Reference	Weight kg
Kits including an analog input or output electronic module, a bus base and a terminal block	TM5 SAI4L + TM5 ACBM11 + TM5 ACTB12	TM5 SAI4LK	0.075
	TM5 SAI4H + TM5 ACBM11 + TM5 ACTB12	TM5 SAI4PHK	0.075
	TM5 SAO4L + TM5 ACBM11 + TM5 ACTB12	TM5 SAO4LK	0.075

<b>Applications</b>	Upcounting, downcounting, period measurement, frequency meter, frequency generator, axis following with encoder
<b>Compatibility</b>	Modicon M258 logic controller, Modicon LMC058 motion controller



<b>Channel connection</b>	With removable spring terminal blocks (to be ordered separately)	
<b>Number of counter channels</b>	2	1
<b>IEC/EN 61131-2 conformity</b>	Type 1	Incremental
<b>Type of signal (1)</b>	Sink	Sink
<b>Type of input</b>	1-, 2- or 3-wire	–
<b>Nominal input voltage</b>	24 V $\overline{\text{DC}}$	24 V $\overline{\text{DC}}$ asymmetrical
<b>Voltage limit values</b>	20.4... 28.8 V $\overline{\text{DC}}$	–
<b>Frequency per channel</b>	50 kHz	100 kHz
<b>Resolution</b>	–	16/32 bits
<b>Functions</b>	Event counting Interval measurement	2 x 24 V $\overline{\text{DC}}$ auxiliary inputs 24 V $\overline{\text{DC}}$ encoder power supply
<b>Types of counter module</b>	<b>TM5 SDI2DF</b>	<b>TM5 SE1IC01024</b>
<b>Compatible bus base (2)</b>	<b>TM5 ACBM11, TM5 ACBM15</b>	
<b>Compatible terminal block (2)</b>	<b>TM5 ACTB12</b>	
<b>Page</b>	35	

(1) Source output: PNP output, sink output: NPN output.  
 (2) To be ordered separately.



Upcounting, downcounting, period measurement, frequency meter, frequency generator, axis following with encoder

Modicon M258 logic controller, Modicon LMC058 motion controller



With removable spring terminal blocks (to be ordered separately)

2	1	1
Incremental	Incremental	SSI absolute
Sink	RS422, Sink	Sink
–	–	–
24 V $\overline{\text{---}}$ asymmetrical	5 V $\overline{\text{---}}$ symmetrical	5 V $\overline{\text{---}}$ symmetrical
–	20.4... 28.8 V $\overline{\text{---}}$	20.4... 28.8 V $\overline{\text{---}}$
100 kHz	250 kHz	1 MHz
16/32 bits	16/32 bits	32 bits
2 x 24 V $\overline{\text{---}}$ auxiliary inputs 24 V $\overline{\text{---}}$ encoder power supply	2 x 24 V $\overline{\text{---}}$ auxiliary inputs	2 x 24 V $\overline{\text{---}}$ auxiliary inputs
<b>TM5 SE2IC01024</b>	<b>TM5 SE1IC02505</b>	<b>TM5SE1SC10005</b>

**TM5 ACBM11, TM5 ACBM15**

**TM5 ACTB12**

35

#### Presentation

**TM5 SDI12DF** and **TM5 SE●●●●●●●●** Expert modules for Modicon LMC058 motion controllers are used to count the pulses generated by a sensor or to process the signals from an incremental encoder, depending on the reference chosen. The extent of the high-speed counter module offer makes it possible to adapt the configuration to the machine's precise requirements: the five counter modules differ in their frequency and their functions.

Expert electronic modules	No. of channels	Max. frequency	Integrated functions	Signal
<b>TM5 SDI12DF</b>	2	50 kHz	Event counting, interval measurement	Sink
<b>TM5 SE1IC01024</b>	1	100 kHz	2 x 24 V $\overline{\text{---}}$ auxiliary inputs 24 V $\overline{\text{---}}$ encoder power supply	Sink
<b>TM5 SE2IC01024</b>	2	100 kHz	2 x 24 V $\overline{\text{---}}$ auxiliary inputs 24 V $\overline{\text{---}}$ encoder power supply	Sink
<b>TM5 SE1IC02505</b>	1	250 kHz	2 x 24 V $\overline{\text{---}}$ auxiliary inputs $\overline{\text{---}}$ 5 V encoder power supply	Sink
<b>TM5 SE1SC10005</b>	1	1 MHz	2 x 24 V $\overline{\text{---}}$ auxiliary inputs $\overline{\text{---}}$ 5 V SSI encoder power supply	Sink

The function parameters are set by configuration using SoMachine software.

Each Expert module consists of three parts to be ordered separately:

- An electronic counter module
- A bus base
- A terminal block

These modules can be mechanically assembled before mounting on a symmetrical rail.

These modules offer the following advantages:

- Removable terminal
- Spring terminals which can be used for quick, tool-free connection of the sensors and preactuators in addition, the quality of the spring terminals avoids the need for periodic retightening
- Hot swapping

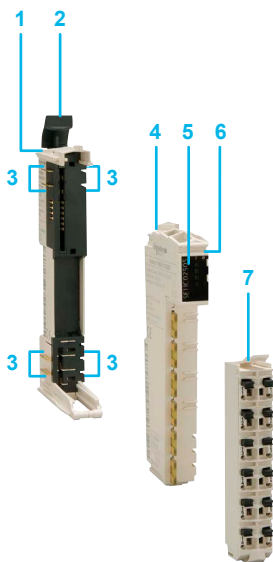

#### Description

TM5 Expert modules comprise:

- 1 A bus base
- 2 A mechanical locking lever for mounting/dismounting on a symmetrical rail
- 3 On each side of the base, a bus expansion connection for the link with the previous controller or module
- 4 An electronic counter module
- 5 A channel and module diagnostics LED display block
- 6 A slot for labelling (label-holder)
- 7 A removable spring terminal block with locking lever and slots for coloured identifiers



Device colour: white



TM5 SDI2DF



TM5 SE●●●●●●●●



TM5 ACBM●●



TM5 ACTB●●



TM5 ACTLC100



TM5 ACTCH100

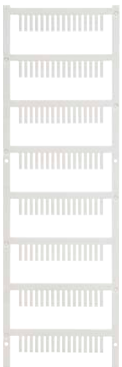

TM5 ACLITW1



TM5 ACLT1



TM5 ACLPL10



TM5 ACLPR10



TM5 ACADL100

### References

#### Expert electronic modules

Counting frequency	Number of channels	Function	Reference	Weight kg
50 kHz	2	Event counting, interval measurement	TM5 SDI2DF	0.025
100 kHz	1	2 x 24 V $\overline{\text{---}}$ auxiliary inputs 24 V $\overline{\text{---}}$ encoder power supply	TM5 SE1IC01024	0.025
	2	2 x 24 V $\overline{\text{---}}$ auxiliary inputs 24 V $\overline{\text{---}}$ encoder power supply	TM5 SE2IC01024	0.025
250 kHz	1	2 x 24 V $\overline{\text{---}}$ auxiliary inputs	TM5 SE1IC02505	0,025
1 MHz	1	2 x 24 V $\overline{\text{---}}$ auxiliary inputs	TM5SE1SC10005	0,025

#### Bus bases

Power supply	Characteristics	Sold in lots of	Unit reference	Weight kg
24 V $\overline{\text{---}}$	–	1	TM5 ACBM11	0.020
		10	TM5 ACBM1110	0.020
	Address setting	1	TM5 ACBM15	0.020
		10	TM5 ACBM1510	0.020

#### Terminal blocks

Use	Description	Sold in lots of	Unit reference	Weight kg
For electronic counter module powered with 24 V $\overline{\text{---}}$	12 contacts	1	TM5 ACTB12	0.020
		10	TM5 ACTB1210	0.020

#### Accessories

Designation	Used for	Colour	Sold in lots of	Unit reference	Weight kg
Plain text cover holder (label-holder)	Marking the terminal blocks on the I/O channels	Transparent	100	TM5 ACTCH100	0.002
Plain text cover holder locking clip <i>(Order with plain text cover holder TM5 ACTCH100)</i>	Locking plain text cover holder TM5 ACTCH100	Transparent	100	TM5 ACTLC100	0.001
Precut legend strips of paper	Plain text cover holder TM5 ACTCH100	White	100	TM5 ACTLS100	0.001
Coloured plastic identifiers	Labelling 16 connection channel terminals	White	1	TM5 ACLITW1	0.015
		Red	1	TM5 ACLITR1	0.015
		Blue	1	TM5 ACLITB1	0.015
Metal tool	Inserting/removing TM5 ACLIT●1 identifiers	Black	1	TM5 ACLT1	0.030
Retaining plates for bus bases	Held on the left side	White	10	TM5 ACLPL10	0.004
	Held on the right side	White	10	TM5 ACLPR10	0.004
Locking clips	For modules	Black	100	TM5 ACADL100	0.001

#### Presentation

TM5 SP●● power distribution modules are intended to supply power to the I/O modules and/or the TM5 bus.

Each power distribution module consists of three parts to be ordered separately:

- A power distribution electronic module
- A bus base
- A terminal block

These modules can be mechanically assembled before mounting on a symmetrical rail.

These modules offer the following advantages:

- Removable terminal
- Spring terminals which can be used for quick, tool-free connection of the sensors and preactuators in addition, the quality of the spring terminals avoids the need for periodic retightening

Four power distribution modules are available

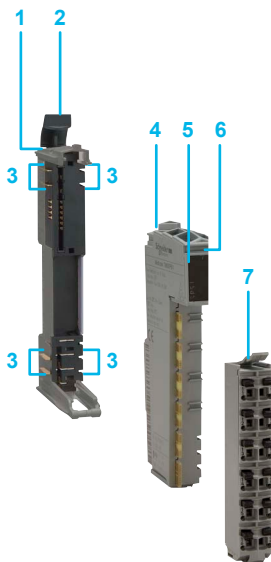

#### Description

Power distribution modules comprise:

- 1 A bus base
- 2 A mechanical locking lever for mounting/dismounting on a symmetrical rail
- 3 On each side of the base, a bus expansion connection for the link with the previous controller or module
- 4 A power distribution electronic module
- 5 A channel and module diagnostics LED display block
- 6 A slot for labelling (label-holder)
- 7 A removable spring terminal block with locking lever and slots for coloured identifiers

Device colour: grey



TM5 SP●●



TM5 ACBM●●



TM5 ACTB●●



TM5 ACTLC100



TM5 ACTCH100

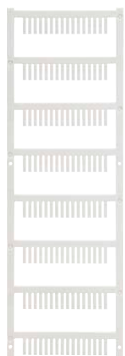

TM5 ACLITW1



TM5 ACLT1



TM5 ACLPL10



TM5 ACLPR10



TM5 ACADL100

## References

### Power distribution electronic modules

Input power supply	Used for	Fuse	Reference	Weight kg
24 V ~	Supplying power to the I/O modules in 24 V ~ Total I max: 10 A	–	<b>TM5 SPS1</b>	0.030
		6.3 A internal fuse	<b>TM5 SPS1F</b>	0.030
24 V ~	Supplying power to the I/O modules in 24 V ~ and the TM5 bus (Bus power supply: 7 W)	–	<b>TM5 SPS2</b>	0.030
		6.3 A internal fuse	<b>TM5 SPS2F</b>	0.030

### Bus bases

Power supply	Characteristics	Sold in lots of	Unit reference	Weight kg
24 V ~	Isolated on the left on the power supply to the I/O modules in 24 V ~	1	<b>TM5 ACBM01R</b>	0.020
		10	<b>TM5 ACBM01R10</b>	0.020
24 V ~	Isolated on the left on the power supply to the I/O modules in 24 V ~ Address setting	1	<b>TM5 ACBM05R</b>	0.020
		10	<b>TM5 ACBM05R10</b>	0.020

### Terminal block

Use	Characteristics	Reference	Weight kg
For power distribution electronic module 24 V ~	12 contacts	<b>TM5 ACTB12PS</b>	0.020

### Accessories

Description	Used for	Colour	Sold in lots of	Unit reference	Weight kg
Plain text cover holder (label-holder)	Marking the terminal blocks on the I/O channels	Transparent	100	<b>TM5 ACTCH100</b>	0.002
Plain text cover holder locking clip (Order with plain text cover holder TM5 ACTCH100)	Locking plain text cover holder TM5 ACTCH100	Transparent	100	<b>TM5 ACTLC100</b>	0.001
Precut legend strips of paper	Plain text cover holder TM5 ACTCH100	White	100	<b>TM5 ACTLS100</b>	0.001
Coloured plastic identifiers	Labelling 16 connection channel terminals	White	1	<b>TM5 ACLITW1</b>	0.015
		Red	1	<b>TM5 ACLITR1</b>	0.015
		Blue	1	<b>TM5 ACLITB1</b>	0.015
Metal tool	Inserting/removing TM5 ACLIT●1 identifiers	Black	1	<b>TM5 ACLT1</b>	0.030
Retaining plates for bus bases	Held on the left side	White	10	<b>TM5 ACLPL10</b>	0.004
	Held on the right side	White	10	<b>TM5 ACLPR10</b>	0.004
Locking clips	For modules	Black	100	<b>TM5 ACADL100</b>	0.001

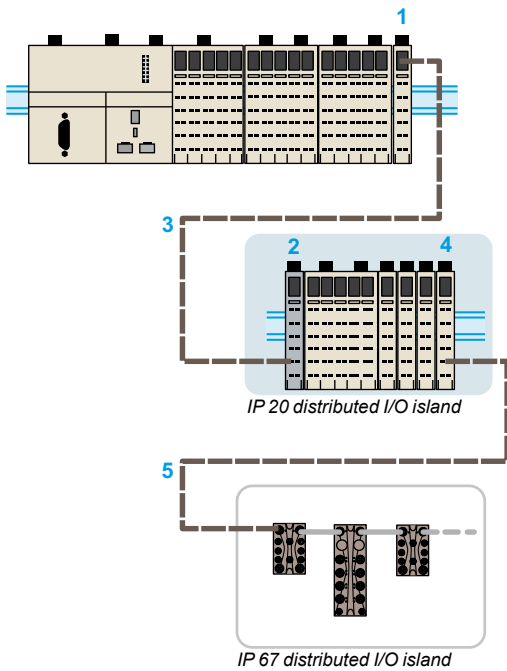

### Presentation

LMC058 motion controllers offer the possibility of creating IP 20 islands of distributed I/O via the TM5 expansion bus.

This makes it possible to:

- Adapt the architecture as closely as possible to the machine topology
- Reduce the wiring costs by minimizing the distance between the modules and the sensors/preactuators
- Take full advantage of the TM5 expansion bus exchange performance
- Save the cost of a fieldbus connection

In addition, irrespective of the expansion module local or remote slot, the modules remain synchronized due to use of the same expansion bus. Modicon TM5 Remote modules are needed to:

- Increase the number of remote I/O on LMC058 motion controller beyond 100 m
- Exchange incoming and outgoing data produced by the I/O expansion modules
- Guarantee the performance of data exchanges

Three remote modules are available:

- The **TM5 SBET1** electronic module: transmitter (1), white, for data transmission between IP 20 islands
- The **TM5 SBET7** electronic module: transmitter (4), white, for data transmission from an IP 20 island to an IP 67 island (1) via a TM7 expansion bus (5)
- TM5 SBER2** electronic modules: receiver (2), grey like all the power distribution modules

The transmitter (1) and receiver (2) modules are physically linked by the remote connection cable (3) **TCS XCNNXN100**.

The maximum distance between islands is 100 m and it is possible to connect up to 25 remote islands.

Each remote module consists of three parts to be ordered separately:

- An electronic module, either transmitter or receiver
- A bus base
- A connection block

These modules can be mechanically assembled before mounting on a symmetrical rail.

These modules offer the following advantages:

- Removable connector
- Spring terminals which can be used for quick, tool-free connection of the sensors and preactuators. In addition, the quality of the spring terminals avoids the need for periodic retightening

### Description

Transmitter and receiver modules comprise:

- 1 A bus base
- 2 A mechanical locking lever for mounting/dismounting on a symmetrical rail
- 3 On each side of the base, a bus expansion connection for the link with the previous controller or module
- 4 A remote I/O electronic module, either transmitter or receiver
- 5 A channel and module diagnostics LED display block
- 6 A slot for labelling (label-holder)
- 7 A removable spring terminal block with locking lever and slots for coloured identifiers

(1) IP 67 islands. Composition: TM7 blocks and TM7 expansion bus. See page 40.

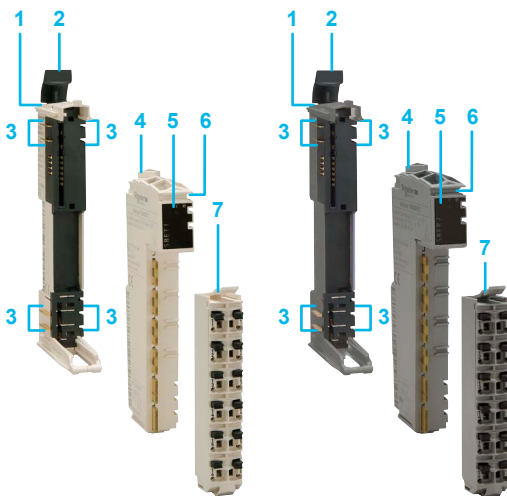

Transmitter module

Receiver module



TM5 SBET1



TM5 SBET7



TM5 SBER2



TM5 ACBM1●



TM5 ACBM0●R



TM5 ACTB●●



TM5 ACTB12PS



TM5 ACTLC100



TM5 ACTCH100

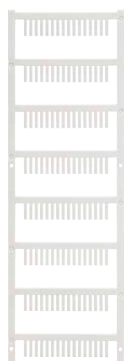

TM5 ACLITW1



TM5 ACLT1



TM5 ACLPL10



TM5 ACLPR10



TM5 ACADL100

### References

#### Remote I/O electronic modules

Description	Characteristics	Reference	Weight kg
<b>Transmitter module</b>	Electronic module for data transmission between IP 20 I/O islands (1) Module colour: white	<b>TM5 SBET1</b>	0.025
	Electronic module for data transmission between IP 20 I/O island and IP 67 I/O island (2) Module colour: white Includes the power supply for the TM7 expansion modules (2)	<b>TM5 SBET7</b>	0.025
<b>Receiver module</b>	Data reception electronic module Power distribution module for electronic modules and the TM5 bus, 24 V $\overline{\text{DC}}$ power supply Module colour: grey	<b>TM5 SBER2</b>	0.025

#### Expansion bus

Description	Usage	Length	Reference	Weight kg
<b>Remote connection cable</b>	Bus extension by linking transmitter and receiver modules	100 m	<b>TCS XCNNXN100</b>	8.800

#### Bus bases

Power supply	For use with	Sold in lots of	Unit reference	Weight kg
-	TM5 SBET1 and TM5 SBET7 transmitter modules	1	<b>TM5 ACBM11</b>	0.020
		10	<b>TM5 ACBM1110</b>	0.020
	TM5 SBET1 and TM5 SBET7 transmitter modules with address setting	1	<b>TM5 ACBM15</b>	0.020
		10	<b>TM5 ACBM1510</b>	0.020
24 V $\overline{\text{DC}}$	TM5 SBER2 receiver module	1	<b>TM5 ACBM01R</b>	0.020
		10	<b>TM5 ACBM01R10</b>	0.020
	TM5 SBER2 receiver module, with address setting	1	<b>TM5 ACBM05R</b>	0.020
		10	<b>TM5 ACBM05R10</b>	0.020

#### Terminal blocks

For use with	Characteristics	Sold in lots of	Unit reference	Weight kg
<b>Transmitter module TM5 SBET1</b>	6 contacts	1	<b>TM5 ACTB06</b>	0.016
		10	<b>TM5 ACTB0610</b>	0.016
<b>Transmitter modules TM5 SBET1 and TM5 SBET7</b>	12 contacts	1	<b>TM5 ACTB12</b>	0.020
		10	<b>TM5 ACTB1210</b>	0.020
<b>Receiver module TM5 SBER2</b>	12 contacts	1	<b>TM5 ACTB12PS</b>	0.020

#### Accessories

Description	Used for	Colour	Sold in lots of	Unit reference	Weight kg
<b>Plain text cover holder (label-holder)</b>	Marking the connection blocks on the I/O channels	Transparent	100	<b>TM5 ACTCH100</b>	0.002
<b>Plain text cover holder locking clip</b> (Order with plain text cover holder TM5 ACTCH100)	Locking plain text cover holder	Transparent	100	<b>TM5 ACTLC100</b>	0.001
<b>Precut legend strips of paper</b>	Plain text cover holder TM5 ACTCH100	White	100	<b>TM5 ACTLS100</b>	0.001
<b>Coloured plastic identifiers</b>	Marking the 16 connection channel terminals	White	1	<b>TM5 ACLITW1</b>	0.015
		Red	1	<b>TM5 ACLITR1</b>	0.015
		Blue	1	<b>TM5 ACLITB1</b>	0.015
<b>Metal tool</b>	Inserting/removing TM5 ACLIT●1 identifiers	Black	1	<b>TM5 ACLT1</b>	0.030
<b>Retaining plates for bus bases</b>	Held on the left side	White	10	<b>TM5 ACLPL10</b>	0.004
	Held on the right side	White	10	<b>TM5 ACLPR10</b>	0.004
<b>Locking clips</b>	For modules	Black	100	<b>TM5 ACADL100</b>	0.001

(1) IP 20 I/O islands, see page 58.  
(2) IP 67 I/O islands, see page 40.

#### Presentation

To enhance its “Flexible machine Control” concept, Schneider Electric offers Modicon TM7 IP 67 blocks for mounting outside electrical cabinets, directly on the installation.

The IP 67 protection of these blocks enables them to be used within processes or machines in harsh environments (splashing water, oil, dust, etc.).

They have the following characteristics:

- Dust and damp proof
- Robust and compact
- Rapid wiring, economical to use

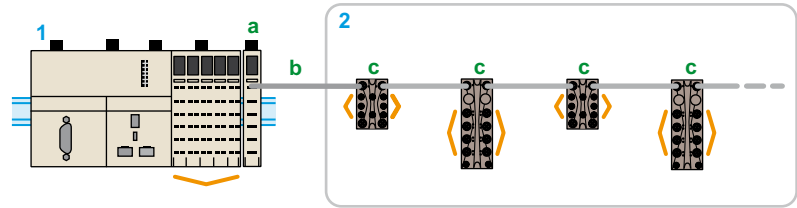

IP 67 distributed I/O island

Inputs/outputs

- 1 Modicon LMC058 motion controller: CANOpen bus masters + transmitter module TM5SBET7 (a) (1).
- 2 IP 67 distributed I/O islands. Composition: TM7 expansion bus cable (b) + TM7 digital/analog I/O expansion blocks (c).

#### Modicon TM7 block offer

Modicon TM7 IP 67 blocks are available in various compositions and for different functions.

##### Digital blocks

The offer comprises:

- Three input blocks
- Three configurable I/O blocks
- One output block

##### Analog blocks

The offer comprises:

- Two expansion blocks with 4 inputs for connecting 4 sensors
- Two expansion blocks with 4 outputs for connecting 4 actuators
- Two mixed expansion blocks with 2 inputs and 2 outputs
- Two expansion blocks with 4 resistive temperature probe or thermocouple temperature measurement channels

##### Power distribution block

A power distribution block is available as an option to supply I/O expansion blocks on the TM7 expansion bus.

This power distribution block is necessary to avoid voltage drops in the following situations:

- With a TM7 NCOM08B CANOpen interface block followed by 4 (2) TM7 I/O expansion blocks
- With a TM5SBET7 transmitter module (1) followed by 6 (2) TM7 I/O expansion blocks (mounted vertically)
- With a TM7 NCOM16A/16B CANOpen interface block followed by 18 (2) TM7 I/O expansion blocks

Note: These limits must be weighted according to the cable lengths.

Consult the SPIG (System Planning and Installation Guide) for the Modicon TM7 IP 67 block offer on [www.schneider-electric.com](http://www.schneider-electric.com)

##### Connection accessories

A range of cables and connectors is available for connecting the:

- CAN bus
- TM7 expansion bus
- I/O
- 24 V  $\bar{\bar{}}$  power supplies on TM7 expansion blocks

##### CANopen interface blocks with digital I/O (see page 62)

The interface I/O block offer comprises IP 67 blocks that connect to a CANOpen bus and have digital channels that can be configured as inputs or outputs, including:

- A CANOpen interface block with 8 configurable I/O for connection via M8 connector
- Two CANOpen interface blocks with 16 configurable I/O



Digital I/O expansion block



Analog I/O expansion block



Power distribution block

(1) TM5 transmitter (see page 38).

(2) Minimum number.



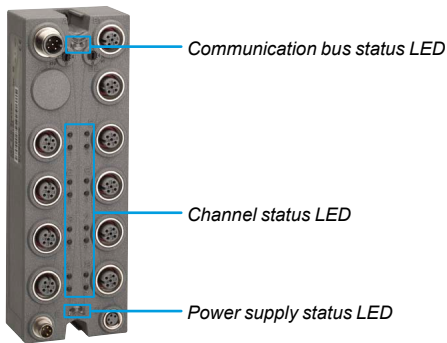

### Diagnostics functions

The diagnostic monitoring of faults is indicated by LEDs on CANopen interface I/O blocks, expansion blocks and power distribution blocks and informs the control system (LMC058 Motion controller, or M340 or Premium automation platforms) via the TM7 bus.

Each Modicon TM7 block has LEDs

- To display the status of the TM7 bus, the channel and the power supply
- For quick, precise location of a fault

There are several levels of diagnostics:

- Diagnostics per channel:
  - State of inputs
  - State of outputs
- Diagnostics per expansion block:
  - Sensor/actuator power supply present
  - Undervoltage fault on the I/O power supply
  - Analog input diagnostics
  - Short-circuit or overload on one or more digital outputs
- Communication bus diagnostics:
  - On CAN bus (CANopen interface I/O block)
  - On TM7 expansion bus (CANopen interface I/O block and I/O expansion blocks)
- Diagnostics of the power supply via the TM7 bus (expansion block only)

### Specifications

<b>Conformity with standards</b>	IEC 61131-2
<b>Product certifications</b>	CE, cURus, GOST-R and c-Tick, ATEX (II 3g EEx nA II T5, IP 67, Ta = 0...60°C)
<b>Temperature</b>	Operation: -10...+60°C (14...140°F) Storage: -25...+85°C (-13...185°F)
<b>Relative humidity</b>	5...95% (without condensation)
<b>Degree of pollution</b> conforming to IEC 60664	2
<b>Degree of protection</b> conforming to IEC 61131-2	IP 67
<b>Altitude</b>	Operation: 0...2000 m (0...6560 ft.) (1) Storage: 0...3000 m (0...9842 ft.)
<b>Vibration resistance</b> DIN rail mounted conforming to IEC 60721-3-5 Class 5M3	7.5 mm (0.295 in.) 2...8 Hz fixed amplitude 20 m/s <sup>2</sup> (2 gn) 8...200 Hz fixed acceleration 40 m/s <sup>2</sup> (4 gn) 200...500 Hz fixed acceleration
<b>Shock resistance</b> conforming to IEC 60721-3-5 Class 5M3	300 m/s <sup>2</sup> (30 gn) for 11 ms, 1/2 sine wave, type 1 shock
<b>Connectors</b>	Type: M8 and/or M12 Number of operations: 50 min.

### Electromagnetic compatibility

<b>Electrostatic discharges</b> conforming to IEC/EN 61000-4-2	± 8 kV, criterion B (air discharge) ± 4 kV, criterion B (direct discharge)
<b>Electromagnetic fields</b> conforming to IEC/EN 61000-4-3	10 V/m, amplitude modulation 80% at 1 kHz (80 MHz...2 GHz) 1 V/m (2...2.7 GHz)
<b>Fast transients</b> conforming to IEC/EN 61000-4-4	Supply: 2 kV, criterion B I/O: 1 kV, criterion B Shielded cable: 1 kV, criterion B Repetition frequency: 5 and 100 kHz
<b>Immunity to overvoltages, 24 V <math>\overline{\text{---}}</math> circuit</b> conforming to IEC/EN 61000-4-5	Supply: □ 1 kV (12 Ω), criterion B in common mode □ 0.5 kV (2 Ω), criterion B in differential mode Unshielded links: □ 1 kV (42 Ω), criterion B in common mode □ 0.5 kV (42 Ω), criterion B in differential mode Shielded links: □ 1 kV (12 Ω), criterion B in common mode □ 0.5 kV (2 Ω), criterion B in differential mode
<b>Induced magnetic fields</b> conforming to IEC/EN 61000-4-6	Line supply, I/O signal connections > 10 m (32.8 ft.) Functional earth connection: 10 Vrms, criterion A, amplitude modulation 80% at 1 kHz (150...80 MHz)
<b>Conducted emissions</b> conforming to EN 55011 (IEC/CISPR11)	150...500 kHz, peak 79 dB μV 500 kHz...30 MHz, peak 73 dB μV
<b>Radiated emissions</b> conforming to EN 55011 (IEC/CISPR11)	30...230 MHz, 10 m (32.8 ft) at 40 dB (μV/m) 230 MHz...1 GHz, 10 m (32.8 ft) at 47 dB (μV/m)

(1) Temperature reduction of 0.5°C (32.9°F) for every additional 100 m (328 ft.) altitude above 2000 m (6560 ft.). Refer to the instruction sheet for each product, downloadable from [www.schneider-electric.com](http://www.schneider-electric.com)

**Applications**

**Digital I/O expansion blocks**



**Degree of protection**

IP 67	IP 67	IP 67
-------	-------	-------

**Type of housing**

Plastic	Plastic	Plastic
---------	---------	---------

<b>Modularity (number of channels)</b>	Max. number of digital channels
	Digital inputs
	Digital outputs

8	16	16
8	16	16
–	–	–

<b>Digital inputs</b>	Voltage/current
	Type
	IEC 61131-2 conformity

24 V $\overline{\text{---}}$ /7 mA	24 V $\overline{\text{---}}$ /7 mA	24 V $\overline{\text{---}}$ /7 mA
Sink (1)	Sink (1)	Sink (1)
Type 1	Type 1	Type 1

<b>Digital outputs</b>	Voltage
	Type
	Current per output
	Current per expansion block

–	–	–
–	–	–
–	–	–
–	–	–

<b>Sensor/actuator power supply</b>	Voltage
	Max. current
	Protection against

24 $\rightarrow$ $\overline{\text{---}}$	24 V $\overline{\text{---}}$	24 V $\overline{\text{---}}$
500 mA for all channels	500 mA for all channels	500 mA for all channels
Overloads, short-circuits and reverse polarity	Overloads, short-circuits and reverse polarity	Overloads, short-circuits and reverse polarity

<b>Connection</b>	TM7 expansion bus	Bus input connector
		Bus output connector
	Digital I/O channels	Sensor connector
		Actuator connector
	Expansion block power supply	Input connector
		Output connector

B-coded 4-way male M12	B-coded 4-way male M12	B-coded 4-way male M12
B-coded 4-way female M12	B-coded 4-way female M12	B-coded 4-way female M12
3-way female M8, 1 channel per connector	3-way female M8, 1 channel per connector	A-coded 5-way female M12, 2 channels per connector
–	–	–
4-way male M8	4-way male M8	4-way male M8
4-way female M8	4-way female M8	4-way female M8

<b>Diagnostics</b>	By expansion block
	By channel
	By communication on TM7 bus

Yes	Yes	Yes
Yes	Yes	Yes
Yes	Yes	Yes

**Type of expansion block**

<b>TM7 BDI8B</b>	<b>TM7 BDI16B</b>	<b>TM7 BDI16A</b>
------------------	-------------------	-------------------

**Pages**

45	45	45
----	----	----

(1) Sink inputs: positive logic  
 (2) Source outputs: positive logic







IP 67	IP 67	IP 67	IP 67
Plastic	Plastic	Plastic	Plastic
8	8	16	16
–	0...8 software-configurable	0...16 software-configurable	0...16 software-configurable
8	0...8 software-configurable	0...16 software-configurable	0...16 software-configurable
–	24 V $\overline{\text{---}}$ /4.4 mA	24 V $\overline{\text{---}}$ /4.4 mA	24 V $\overline{\text{---}}$ /4.4 A max.
–	Sink (1)	Sink (1)	Sink (1)
–	Type 1	Type 1	Type 1
24 V $\overline{\text{---}}$	24 V $\overline{\text{---}}$	24 V $\overline{\text{---}}$	24 V $\overline{\text{---}}$
Transistor/Source (2)	Transistor/Source (2)	Transistor/Source (2)	Transistor/Source (2)
2 A max.	0.5 A max.	0.5 A max.	0.5 A max.
8 A max.	4 A max.	8 A max.	8 A max.
24 V $\overline{\text{---}}$	24 V $\overline{\text{---}}$	24 V $\overline{\text{---}}$	24 V $\overline{\text{---}}$
500 mA for all channels	500 mA for all channels	500 mA for all channels	500 mA for all channels
Overloads, short-circuits and reverse polarity	Overloads, short-circuits and reverse polarity	Overloads, short-circuits and reverse polarity	Overloads, short-circuits and reverse polarity
B-coded 4-way male M12	B-coded 4-way male M12	B-coded 4-way male M12	B-coded 4-way male M12
B-coded 4-way female M12	B-coded 4-way female M12	B-coded 4-way female M12	B-coded 4-way female M12
–	3-way female M8, 1 channel per connector	A-coded 5-way female M12, 2 channels per connector	3-way female M8, 1 channel per connector
3-way female M8, 1 channel per connector	3-way female M8, 1 channel per connector	5-way female M12, 2 channels per connector	3-way female M8, 1 channel per connector
4-way male M8	4-way male M8	4-way male M8	4-way male M8
4-way female M8	4-way female M8	4-way female M8	4-way female M8
Yes	Yes	Yes	Yes
Yes	Yes	Yes	Yes
Yes	Yes	Yes	Yes
<b>TM7 BDO8TAB</b>	<b>TM7 BDM8B</b>	<b>TM7 BDM16A</b>	<b>TM7 BDM16B</b>
45	45	45	45

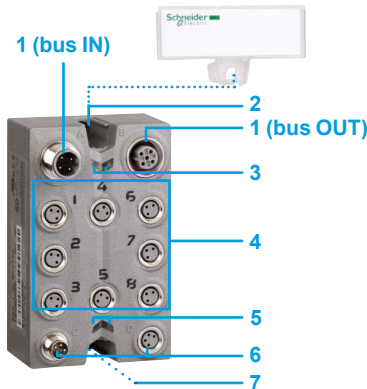

### Description

#### Digital I/O expansion blocks

**8-channel** digital I/O expansion blocks have the following on the front panel:

- 1 A male M12 connector (bus IN) and a female M12 connector (bus OUT) for connecting the TM7 expansion bus
- 2 A slot for the expansion block label (1)
- 3 Two bus diagnostic LEDs
- 4 Eight female M8 connectors for connecting sensors and actuators with LEDs for indicating channel status
- 5 Two LEDs indicating the status of the sensor and actuator 24 V  $\overline{\text{---}}$  power supplies
- 6 Two M8 connectors for connecting the 24 V  $\overline{\text{---}}$  sensor and actuator power supplies: male for PWR IN, female for PWR OUT
- 7 Fixing using two  $\varnothing 4$  screws (not supplied) and connection of the functional earth when fixing the block on a metal support

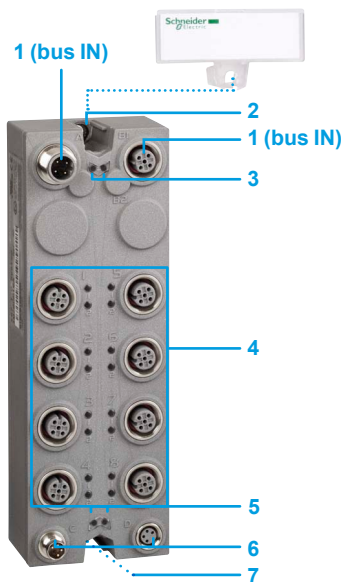

**16-channel** digital I/O expansion blocks have the following on the front panel:

- 1 A male M12 connector (bus IN) and a female M12 connector (bus OUT) for connecting the TM7 expansion bus
- 2 A slot for the expansion block label (1)
- 3 Two bus diagnostic LEDs
- 4 Eight M12 connectors (2 channels per connector) or sixteen M8 connectors for connecting sensors and actuators with LEDs for indicating channel status
- 5 Two LEDs indicating the status of the sensor and actuator 24 V  $\overline{\text{---}}$  power supplies
- 6 Two M8 connectors for connecting the 24 V  $\overline{\text{---}}$  sensor and actuator power supplies: male for PWR IN, female for PWR OUT
- 7 Fixing using two  $\varnothing 4$  screws (not supplied) and connection of the functional earth when fixing the block on a metal support

(1) Label-holder supplied with IP 67 block.

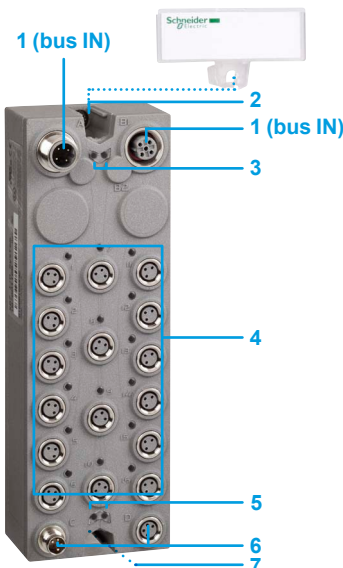



TM7 BDI8B,  
TM7 BDO8TAB,  
TM7 BDM8B



TM7 BDM16B,  
TM7 BDI16B

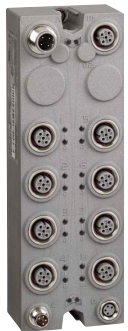

TM7 BDI16A,  
TM7 BDM16A

Digital I/O expansion blocks						
Max. no. of channels	Number, type of inputs (1)	Number, type of outputs (2)	Sensor and actuator connection	Communication bus	Reference	Weight kg
8 input	8, sink (3)	–	8 x female M8 connectors	TM7 bus	<b>TM7 BDI8B</b>	0.180
16 input	16, sink (3)	–	16 x female M8 connectors	TM7 bus	<b>TM7 BDI16B</b>	0.320
	16, sink (3)	–	8 x female M12 connectors	TM7 bus	<b>TM7 BDI16A</b>	0.320
8 output	–	8, transistor/ source (4), 2 A max.	8 x female M8 connectors	TM7 bus	<b>TM7 BDO8TAB</b>	0.185
8 configurable I/O	0...8, sink (3)	0...8, transistor/ source (4), 0.5 A max.	8 x female M8 connectors	TM7 bus	<b>TM7 BDM8B</b>	0.190
16 configurable I/O	0...16, sink (3)	0...16, transistor/ source (4), 0.5 A max.	8 x female M12 connectors	TM7 bus	<b>TM7 BDM16A</b>	0.320
			16 x female M8 connectors	TM7 bus	<b>TM7 BDM16B</b>	0.320

(1) 24 V  $\overline{\text{---}}$  IEC type 1

(2) 24 V  $\overline{\text{---}}$

(3) Sink inputs: positive logic

(4) Source outputs: positive logic

### Architecture, Connecting cables

See page 68

### Connection accessories

See page 70

### Separate parts

See page 71

### Configuration software

- SoMachine software, see page 76
- Performance distributed I/O configuration software, please consult our site [www.schneider-electric.com](http://www.schneider-electric.com)

**Applications**

**Analog I/O expansion blocks**



<b>Degree of protection</b>		IP 67	IP 67	IP 67	
<b>Type of housing</b>		Plastic	Plastic	Plastic	
<b>Modularity (number of channels)</b>	Max. number of analog channels	4	4	4	
	Analog inputs	4	4	–	
	Temperature inputs	–	–	4	
	Analog outputs	–	–	–	
<b>Inputs</b>	Type	Voltage - 10...+ 10 V $\ddot{=}$	Current 0...20 mA	Pt 100 temperature probe, Pt 1000 temperature probe, KTY 10 silicon temperature probe, KTY 84 silicon temperature probe, Resistance 0...3276 Ohm	
	Resolution	11 bits + sign	12 bits	16 bits	
<b>Analog outputs</b>	Type	–	–	–	
	Resolution	–	–	–	
	Current per expansion block	–	–	–	
<b>Sensor/actuator power supply</b>	Voltage	24 V $\ddot{=}$	24 V $\ddot{=}$	–	
	Max. current	500 mA for all channels	500 mA for all channels	–	
	Protection against	Overloads, short-circuits and reverse polarity	Overloads, short-circuits and reverse polarity	–	
<b>Connection</b>	TM7 expansion bus	Bus input connector	4-way male M12 B-coded	4-way male M12 B-coded	4-way male M12 B-coded
		Bus output connector	4-way female M12 B-coded	4-way female M12 B-coded	4-way female M12 B-coded
	Analog I/O channels	Sensor connector	5-way female M12 A-coded	5-way female M12 A-coded	5-way female M12 A-coded
		Actuator connector	–	–	–
	Expansion block power supply	Input connector	4-way male M8	4-way male M8	4-way male M8
		Output connector	4-way female M8	4-way female M8	4-way female M8
<b>Diagnostics</b>	By expansion block	Yes	Yes	Yes	
	By channel	Yes	Yes	Yes	
	By communication on TM7 bus	Yes	Yes	Yes	
<b>Type of expansion block</b>		<b>TM7 BAI4VLA</b>	<b>TM7 BAI4CLA</b>	<b>TM7 BAI4TLA</b>	
<b>Pages</b>		48			





IP 67	IP 67	IP 67	IP 67	IP 67
Plastic	Plastic	Plastic	Plastic	Plastic
4	4	4	4	4
–	–	–	2	2
4	–	–	–	–
–	4	4	2	2
J, K, S thermocouple Voltage 0...65536 µV	–	–	Voltage - 10... + 10 V $\overline{\text{---}}$	Current 0...20 mA
16 bits	–	–	11 bits + sign	12 bits
–	Voltage - 10... + 10 V $\overline{\text{---}}$	Current 0...20 mA	Voltage - 10... + 10 V $\overline{\text{---}}$	Current 0...20 mA
–	11 bits + sign	12 bits	11 bits + sign	12 bits
–	–	–	–	–
–	24 V $\overline{\text{---}}$	24 V $\overline{\text{---}}$	24 V $\overline{\text{---}}$	24 V $\overline{\text{---}}$
–	500 mA for all channels	500 mA for all channels	500 mA for all channels	500 mA for all channels
–	Overloads, short-circuits and reverse polarity	Overloads, short-circuits and reverse polarity	Overloads, short-circuits and reverse polarity	Overloads, short-circuits and reverse polarity
4-way male M12 B-coded	4-way male M12 B-coded	4-way male M12 B-coded	4-way male M12 B-coded	4-way male M12 B-coded
4-way female M12 B-coded	4-way female M12 B-coded	4-way female M12 B-coded	4-way female M12 B-coded	4-way female M12 B-coded
A-coded 5-way female M12	–	–	A-coded 5-way female M12	A-coded 5-way female M12
–	A-coded 5-way female M12	A-coded 5-way female M12	A-coded 5-way female M12	A-coded 5-way female M12
4-way male M8	4-way male M8	4-way male M8	4-way male M8	4-way male M8
4-way female M8	4-way female M8	4-way female M8	4-way female M8	4-way female M8
Yes	Yes	Yes	Yes	Yes
Yes	Yes	Yes	Yes	Yes
Yes	Yes	Yes	Yes	Yes
<b>TM7 BAI4PLA</b>	<b>TM7 BAO4VLA</b>	<b>TM7 BAO4CLA</b>	<b>TM7 BAM4VLA</b>	<b>TM7 BAM4CLA</b>

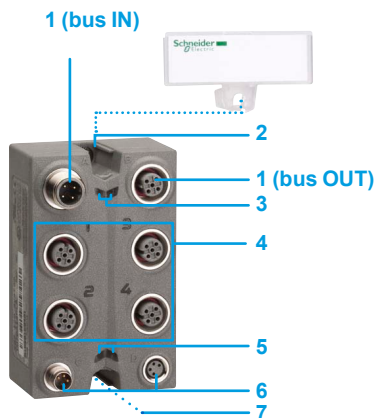

### Description

#### Analog I/O expansion blocks

Analog I/O expansion blocks have the following on the front panel:

- 1 A male M12 connector (bus IN) and a female M12 connector (bus OUT) for connecting the TM7 expansion bus
- 2 A slot for the expansion block label (1)
- 3 Two bus diagnostic LEDs
- 4 Four female M12 connectors for connecting sensors and/or actuators with LEDs for indicating channel status
- 5 Two LEDs indicating the status of the sensor and actuator 24 V  $\bar{\text{---}}$  power supplies
- 6 Two M8 connectors for connecting the 24 V  $\bar{\text{---}}$  sensor and actuator power supplies: male for PWR IN, female for PWR OUT
- 7 Fixing using two  $\varnothing 4$  screws (not supplied) and connection of the functional earth when fixing the block on a metal support

(1) Label-holder supplied with IP 67 block.

### Analog I/O expansion blocks



TM7 BAI4●LA,  
TM7 BAO4●LA,  
TM7 BAM4●LA

Max. no. of channels	Input range	Output range	Resolution	Sensor and actuator connection	Communication bus	Reference	Weight kg
4 input	Voltage	–	11 bits + sign	4 female M12 connectors	TM7 bus	TM7 BAI4VLA	0.200
	Current 0...20 mA	–	12 bits	4 female M12 connectors	TM7 bus	TM7 BAI4CLA	0.200
	Pt 100, Pt 1000 temperature probe KTY 10, KTY 84 silicon temperature probe Resistance 0...3276 $\Omega$	–	16 bits	4 female M12 connectors	TM7 bus	TM7 BAI4TLA	0.200
	J, K, S thermocouple Voltage 0...65536 $\mu\text{V}$	–	16 bits	4 female M12 connectors	TM7 bus	TM7 BAI4PLA	0.200
4 output	–	Voltage - 10...+ 10 V $\bar{\text{---}}$	11 bits + sign	4 female M12 connectors	TM7 bus	TM7 BAO4VLA	0.200
	–	Current 0...20 mA	12 bits	4 female M12 connectors	TM7 bus	TM7 BAO4CLA	0.200
2 input + 2 output	Voltage - 10...+ 10 V $\bar{\text{---}}$	Voltage - 10...+ 10 V $\bar{\text{---}}$	11 bits + sign	4 female M12 connectors	TM7 bus	TM7 BAM4VLA	0.200
	Current 0...20 mA	Current 0...20 mA	12 bits	4 female M12 connectors	TM7 bus	TM7 BAM4CLA	0.200

#### Architecture, Connecting cables

See page 68

#### Connection accessories

See page 70

#### Separate parts

See page 71

#### Configuration software

- SoMachine software, see page 76
- Performance distributed I/O configuration software, please consult our site [www.schneider-electric.com](http://www.schneider-electric.com)

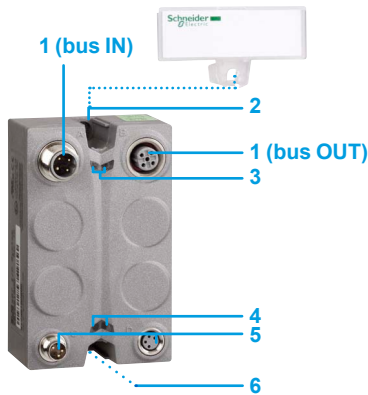

TM7 SPS1A

## Description

### Power distribution block

The power distribution block has the following on the front panel:

- 1 A male M12 connector (bus IN) and a female M12 connector (bus OUT) for connecting the TM7 expansion bus
- 2 A slot for the power distribution block label (1)
- 3 Two TM7 bus diagnostic LEDs
- 4 Two LEDs indicating the status of the sensor and actuator 24 V  $\overline{\text{---}}$  power supplies
- 5 Two M8 connectors for connecting the 24 V  $\overline{\text{---}}$  sensor and actuator power supplies: male for PWR IN, female for PWR OUT
- 6 Fixing using two  $\varnothing$  4 screws (not supplied) and connection of the functional earth when fixing the block on a metal support

(1) Label-holder supplied with IP 67 block.

### Power distribution block

Function	Connection	Communication bus	Reference	Weight kg
24 V $\overline{\text{---}}$ /15 W power supply for I/O expansion blocks on the TM7 expansion bus	Supply: 2xM8 connectors, 1 male and 1 female TM7 bus: 2xM12 connectors, 1 male and 1 female	TM7 bus	TM7 SPS1A	0.190

### Architecture, Connecting cables

See page 66

### Connection accessories

See page 70

### Separate parts

See page 71

### Configuration software

- SoMachine software, see page 76
- Performance distributed I/O configuration software, please consult our site [www.schneider-electric.com](http://www.schneider-electric.com)

# Modicon LMC058 Motion controller

## Communication

Modicon TM5 communication module  
for connection to the Profibus DP fieldbus

### Presentation

#### Profibus DP (Decentralized Peripherals)

Profibus (Process Field Bus) is a fieldbus for controlling decentralized sensors, actuators or PLCs via a central master controller.

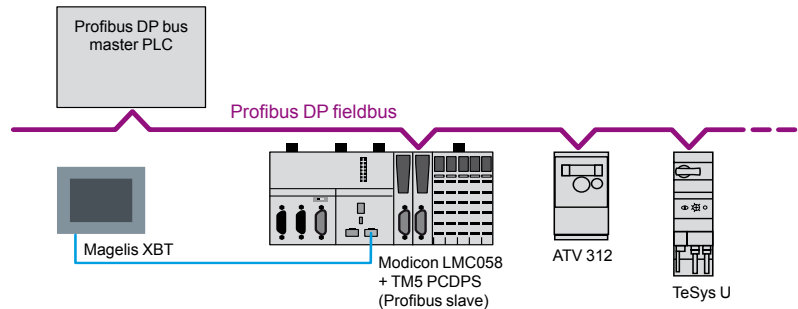

#### Connectable devices

The following Schneider Electric devices can be connected to this bus:

- Modicon LMC 058LF42 and LMC 058LF424 motion controllers equipped with the **TM5 PCDPS** communication module
- TeSys U and TeSys T starter-controllers
- Momentum and Modicon STB distributed I/O
- Altivar 312/61/71 variable speed drives for asynchronous motors
- Lexium 05 and 15 servo drives for brushless motors
- Altistart ATS 48 soft start-soft stop units

And any third-party device compatible with Profibus DP standard profiles.

#### Profibus communication module

The **TM5 PCDPS** communication module is designed for **LMC 058LF424** motion controllers and is installed in one of the two free PCI slots.

The **TM5 PCDPS** communication module is used to configure the connection as a slave on the Profibus DP fieldbus.

**Note:** The maximum number of communication modules is two (see page 54) with a single **TM5 PCDPS** Profibus DP slave communication module.

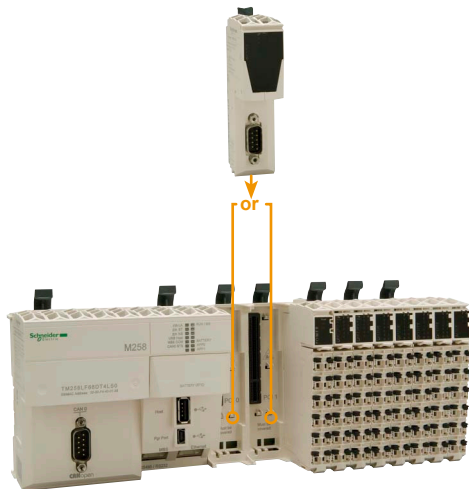

TM5 PCDPS communication module: For mounting on one of the two free PCI slots on an LMC058 Motion controller

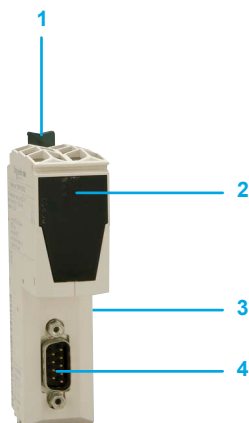

### Description

The **TM5 PCDPS** communication module features:

- 1 A locking clip for mounting/removing the module onto/from the logic controller or motion controller
- 2 A LED display block for the module channels and diagnostics
- 3 A connector for linking the logic controller or motion controller
- 4 A SUB-D connector (male 9-way) for connection to the Profibus fieldbus



# Modicon LMC058 Motion controller

## Communication

Modicon TM5 communication module  
for connection to the Profibus DP fieldbus



TM5 PCDPS



490 NAD 911 03

### References

#### Modicon TM5 communication module

Description	For use with	Profile	Built-in port	Reference	Weight kg
<b>Communication module for Profibus DP</b> (244 I/O data bits)	Motion controllers: □ LMC 058LF42 □ LMC 058LF424	V1 slave	SUB-D connector (male 9-way)	<b>TM5 PCDPS</b>	0.064

#### Profibus DP fieldbus connection components

Description	Length	Item no.	Reference	Weight kg
<b>Profibus DP connection cables</b>	100 m	1	<b>TSX PBS CA 100</b>	–
	400 m	1	<b>TSX PBS CA 400</b>	–

Description	Type	Item no.	Reference	Weight kg
<b>Remote I/O on Profibus DP fieldbus</b>	Modicon STB network interface module	–	<b>STB NDP 2112</b>	0.140
<b>Connectors for remote I/O communication module</b>	Line terminator	–	<b>490 NAD 911 03</b>	–
	In-line connector	–	<b>490 NAD 911 04</b>	–
	In-line connector and terminal port	–	<b>490 NAD 911 05</b>	–

#### Modbus cabling system

##### Non-isolated link

(Modicon M258, LMC058 master)

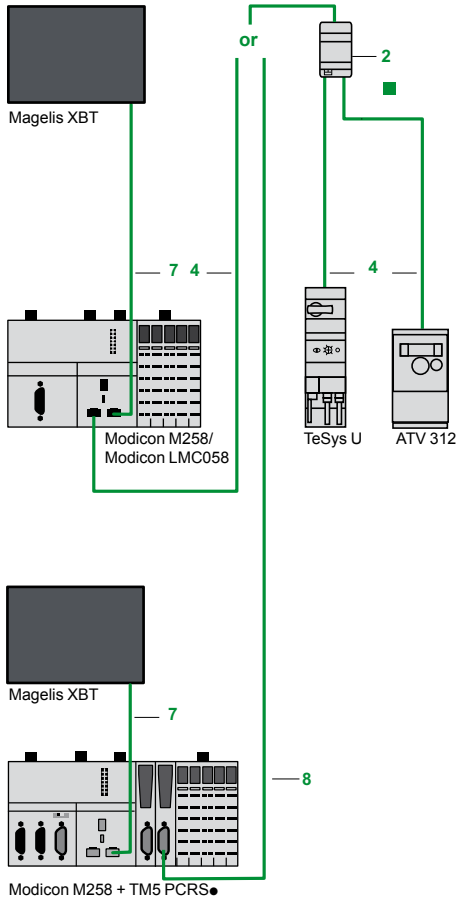

##### Isolated link

(Modicon M258, LMC058 master)

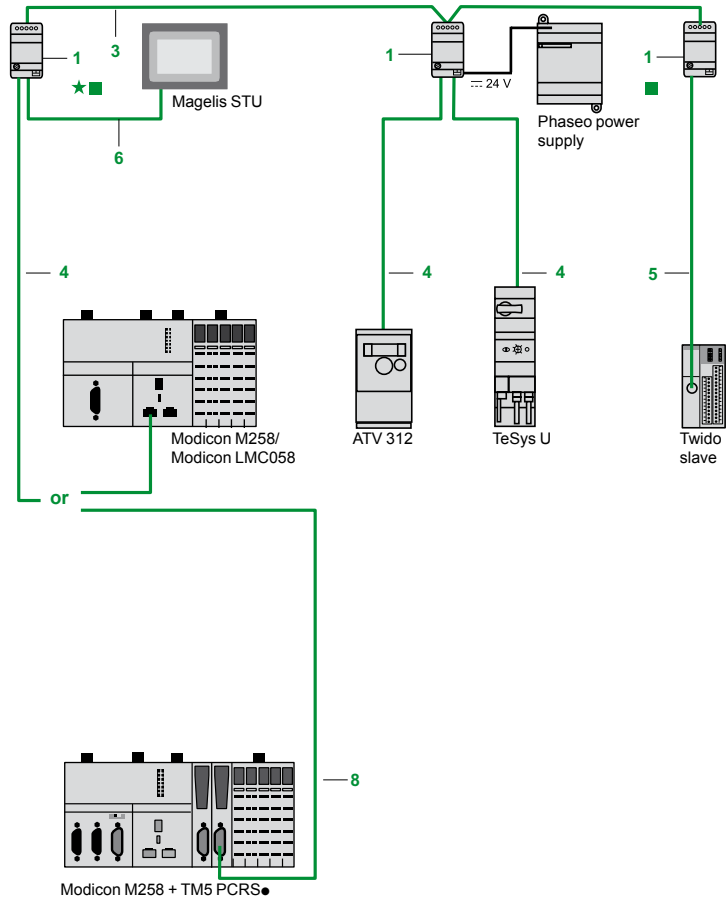

- Length of cables between Modicon M258 and Altivar:  
 $\leq 30$  m max.

- Total length of cables between isolation boxes 1:  $\leq 1000$  m  
 - Length of tap cables 4, 5 or 6:  $\leq 10$  m

- ★ Line polarization active
- Line termination



TWD XCA ISO



TWD XCA T3RJ



LU9 GC3

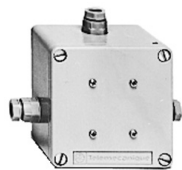

TSX SCA 50



XGS Z24

**References**

**Extension and adaptation elements, cables and cordsets for RS 485 serial link**

Designation	Description	No.	Length	Unit reference	Weight kg	
<b>Isolation box</b> Screw terminal block for trunk cable 2 x RJ45 connectors for tap-off	- Isolation of the RS485 link (1) - Line termination (RC 120 Ω, 1 nF) - Line pre-polarization (2 R 620 Ω), Power supply 24 V [DC symbol] (screw terminal block) or 5 V [DC symbol] (via RJ45), Mounting on 35 mm ⌊	1	–	TWD XCA ISO	0.100	
<b>Junction box</b> 1 RJ45 for trunk cable 2 x RJ45 for tap-off	- Line termination (RC 120 Ω, 1 nF) - Line pre-polarization (2 R 620 Ω), Mounting on 35 mm 5	2	–	TWD XCA T3RJ	0.080	
<b>Modbus splitter box</b> Screw terminal block for trunk cable 10 x RJ45 for tap-off	Mounting on 35 mm ⌊ on plate or panel (2 x Ø 4 mm screws)	–	–	LU9 GC3	0.500	
<b>T-junction boxes</b> 2 x RJ45 for trunk cable	1 integrated cable with RJ45 connector for tap-off dedicated to Altivar variable speed drive	–	0.3 m 1 m	VW3 A8 306 TF03 VW3 A8 306 TF10	– –	
<b>Passive T-junction box</b>	- 1-channel line extension and tap-off on screw terminal block - Line termination	–	–	TSX SCA 50	0.520	
<b>RS 232C/RS 485 line converter</b>	- Max. data rate 19.2 Kbps - No modem signals 24 V ⎓/20 mA power supply, Mounting on 35 mm ⌊	–	–	XGS Z24	0.100	
<b>RS 485 double shielded twisted pair trunk cables</b>	Modbus serial link, supplied without connector	3	100 m 200 m 500 m	TSX CSA 100 TSX CSA 200 TSX CSA 500	5.680 10.920 30.000	
<b>Modbus RS 485 cordsets</b>	2 x RJ45 connectors	4	0.3 m 1 m 3 m	VW3 A8 306 R03 VW3 A8 306 R10 VW3 A8 306 R30	0.030 0.050 0.150	
	1 x RJ45 connector and 1 end with flying leads	–	1 m 3 m	TWD XCA FJ010 VW3 A8 306 D30	0.060 0.150	
	1 x mini-DIN connector for Twido controller and 1 x RJ45 connector	–	0.3 m 1 m 3 m	TWD XCA RJ003 TWD XCA RJ010 TWD XCA RJ030	0.040 0.090 0.160	
	1 x mini-DIN connector for Twido controller and 1 x RJ45 connector (2) (3)	5	0.3 m	TWD XCA RJP03	0.027	
	1 x mini-DIN connector for Twido controller and 1 x RJ45 connector Dedicated to Programming protocol (3) (4)	–	0.3 m	TWD XCA RJP03P	0.027	
	1 mini-DIN connector for Twido controller and 1 end with flying leads	–	1 m 10 m	TWD XCA FD010 TSX CX 100	0.062 0.517	
<b>Cordsets</b> <b>Modicon M258 (SL1, SL2) to Magelis display unit and terminal</b>	2 x RJ45 connectors	XBT N200/R400 XBT RT500/511 XBT GT11●●/1335	7	2.5 m	XBT Z9980	0.150
	1 x RJ45 connector and 1 x 25-way SUB-D connector	Small Panel XBT N401/410 XBT R410/411	6, 7	2.5 m	XBT Z938	0.210
	1 x RJ45 connector and 1 x 9-way SUB-D connector	Advanced Panel XBT GT2●●0...7340 XBT GK●●●0	7	2.5 m	XBT Z9008	0.150
<b>Cordset for Magelis Small Panel display unit and terminal</b>	2 x RJ45 connectors	Small Panel XBT N200/R400 XBT RT500/511	6	3 m	VW3 A8 306 R30	0.150
<b>Line terminator</b>	For RJ45 connector R = 120 Ω, C = 1 nf Sold in lots of 2	–	–	VW3 A8 306 RC	0.200	

**Cordsets for RS 232 serial link**

Designation	Description	No.	Length	Reference	Weight kg
<b>Cordset for DTE terminal (printer) (5)</b>	Serial link for DTE equipment (2) 1 x RJ45 connector and 1 x 9-way female SUB-D connector	8	3 m	TCS MCN 3M4F3C2	0.150
<b>Cordset for DCE terminal (modem, converter)</b>	Serial link for DCE 1 x RJ45 connector and 1 x 9-way male SUB-D connector	8	3 m	TCS MCN 3M4M3S2	0.150

(1) Line isolation recommended for line distances > 10 m.  
 (2) Forces configuration of the Twido controller built-in RS 485 port with the TwidoSuite programming protocol parameters.  
 (3) Carries the 5 V ⎓ voltage (supplied by the Twido controller built-in RS 485 port) required by the TWD XCA ISO isolation box, thus avoiding the need for a 24 V ⎓ external power supply.  
 (4) Allows the Twido controller built-in RS 485 port to be used with the parameters described in the configuration.  
 (5) If the terminal is equipped with a 25-way SUB-D connector, you will also need to order the 25-way female/9-way male SUB-D adaptor TSX CTC 07.

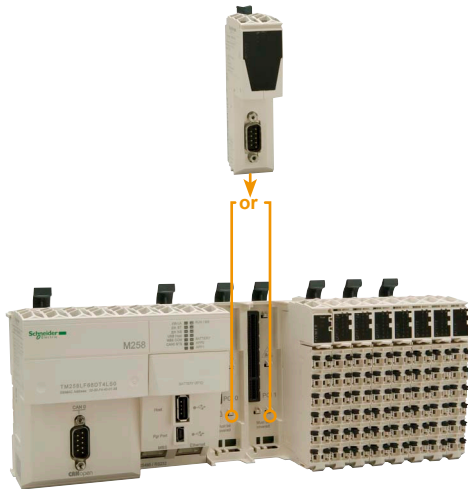

TM5 PCRS communication module: for mounting the two free PCI slots in the LMC058 Motion controller

### Presentation

**TM5 PCRS** communication modules are designed for **LMC 058LF42** and **LMC 058LF424** motion controllers, and are installed in one of the two free PCI slots in.

**TM5 PC** communication modules can be used to configure one or two additional Modbus or ASCII serial links as RS232 or RS485.

*Nota: the maximum number of communication modules is 2.*

### Modbus and Character mode serial links

Cabling system: see page 52.

### Description

**TM5 PCRS** communication modules comprise:

- 1 A locking clip for mounting/dismounting on the controller
- 2 A channel and module diagnostics LED display block
- 3 A connector for linking to the controller
- 4 A SUB-D connector (male 9-way) for connection to the serial link

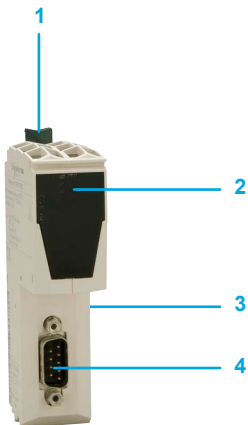

### Serial link

LED	Colour	Status: on
Status	Green	Operation in progress
	Red	Controller starting
RXD	Yellow	Reception on interface: <input type="checkbox"/> RS232 with TM258 PCRS2 <input type="checkbox"/> RS485 with TM258 PCRS4
TXD	Yellow	Transmission on interface: <input type="checkbox"/> RS232 with TM258 PCRS2 <input type="checkbox"/> RS485 with TM258 PCRS4



TM5 PCRS●

References					
Description	Used for	Physical layer/ protocols	Built-in port	Reference	Weight kg
Modbus serial link communication modules	Motion controllers: □ LMC 058LF42, □ LMC 058LF424	RS232/ Modbus/ASCII, SoMachine	SUB-D connector (male 9-way)	<b>TM5 PCRS2</b>	0.064
		RS485 / Modbus/ASCII, SoMachine	SUB-D connector (male 9-way)	<b>TM5 PCRS4</b>	0.064



#### Presentation

Schneider Electric has selected CANopen for its machines and installations because of its wealth of functions and its resulting benefits in the automation world. This decision was based on the general acceptance of CANopen, and the fact that CANopen products are increasingly used in control system architectures. CANopen is an open network supported by more than 400 companies worldwide, and promoted by CAN in Automation (CiA). CANopen conforms to standards EN 50325-4 and ISO 15745-2.

#### CANmotion and CANopen characteristics

CANmotion and CANopen buses are multi-master buses ensuring reliable, deterministic access to real-time data in control system equipment. The CSMA/CA protocol is based on broadcast exchanges, sent cyclically or on an event, to ensure optimum use of the bandwidth. A message handling channel can also be used to define slave parameters.

CANmotion and CANopen buses are a set of profiles on CAN systems with the following characteristics:

- Open bus system
- Data exchanges in real time without overloading the protocol
- Modular design allowing modification of size
- Interconnection and interchangeability of devices
- Standardized network configuration
- Access to all device parameters
- Synchronization and circulation of cyclical and/or event-controlled process data (short system response time)

#### Connectable Schneider Electric devices

The following Schneider Electric devices can be connected to the CANopen bus:

- Ø 58 mm OsiSense XCC multi-turn absolute encoders: **XCC 3510P**, **XCC 3515CS84CB**
- TeSys U starter-controllers with communication module: **LUL C08**
- TeSys T motor management system with controller: **LTM R●●C●●**
- Modicon **TM5** Transmitter/Receiver modules (IP 20)
- Modicon **TM7** I/CANopen interface blocks (IP 67)
- Preventa safety configurable controllers **XPS MC16ZC**, **XPS MC32ZC**.
- Altivar 61/71 variable speed drives for asynchronous motors (0.75...630 kW): **ATV 61H/71H ●●●●●**
- Altivar 32 variable speed drives for asynchronous motors (0,18...15Kw): **ATV 32H●●●●●**
- Lexium 32 servo drives (0.15...7 kW) for BSH/BSM servo motors: **LXM 32A●D●●●●●**
- Lexium **SD3** stepper drives
- Lexium integrated drives: **ILA1B**, **ILE1B** and **ILS1B**

#### CANopen Performance architecture

Wiring system, see page 72.



TeSys U + communication module LUL C08



Modicon TM5 Transmitter/Receiver module



Modicon TM7 CANopen interface Blocks



Preventa XPS MC



Altivar 71



Altivar 32



LEX 32A



Lexium ILA1B

# Modicon LMC058 Motion controller

## Communication Integrated CANopen bus in Modicon LMC058 Motion controller

### Tested Validated Documented Architectures

#### Modicon LMC058 motion controller

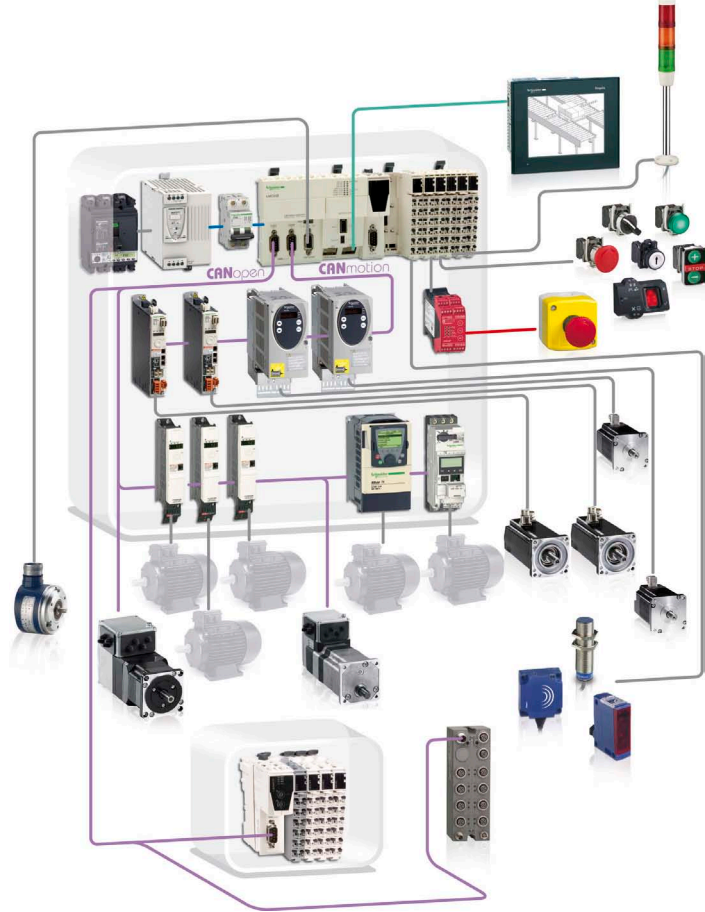

### CANopen port LMC058 motion controller

Modicon LMC058 motion controllers include a 9-way male SUB-D CANopen port and act as the CANopen master.

The bus consists of a master station, M238 logic controller or LMC058 motion controller and slave stations. The master is in charge of configuration, exchanges and diagnostics to the slaves.

The CANopen bus is a communication bus and is used to manage a variety of slaves, such as:

- Digital slaves
- Analog slaves
- Variable speed drives
- Motor starters
- Etc.

#### CANopen port

Standards	DS 301 V4.02, DR 303-1								
Class	Conformity class M10, limited to 63 slaves								
Data rate	Max. length (m)	20	40	100	250	500	1000	2500	5000
	Data rate (kbps)	1000	800	500	250	125	50	20	10
Number of slaves	63 max. with max. limit of: 64 TDPOs/64 RPDOs								
Connection	On 9-way male SUB-D port								

### CANmotion port on LMC058 motion controllers

LMC058 motion controllers include a 9-way male SUB-D CANmotion port and act as the CANmotion master.

This CANmotion connection offers the option of configuring and controlling up to 8 Lexium 32 drives and/or Lexium SD3 stepper drives.

The CANmotion bus cycle time ensures that the axis positions will be refreshed.

# Modicon LMC058 Motion controller Communication

Distributed I/O on CANopen bus  
with Modicon TM5 (IP 20) interface module

## Presentation

To enhance its “Flexible machine Control” concept, a key component of MachineStruxure™, and the Modicon LMC058 Motion controller offers, Schneider Electric offers a Modicon TM5 CANopen interface module providing CANopen access to distributed I/O.

- LMC058 Motion controllers offer the possibility of creating distributed I/O islands via the TM5 expansion bus, which enables the architecture to be adapted to match the topology of the machine as closely as possible and reduces wiring costs.
- The Modicon TM5 CANopen interface module allows the connection of distributed I/O islands (sensors and actuators) that are distributed over machines via the CANopen fieldbus. These islands communicate on the CANopen bus.

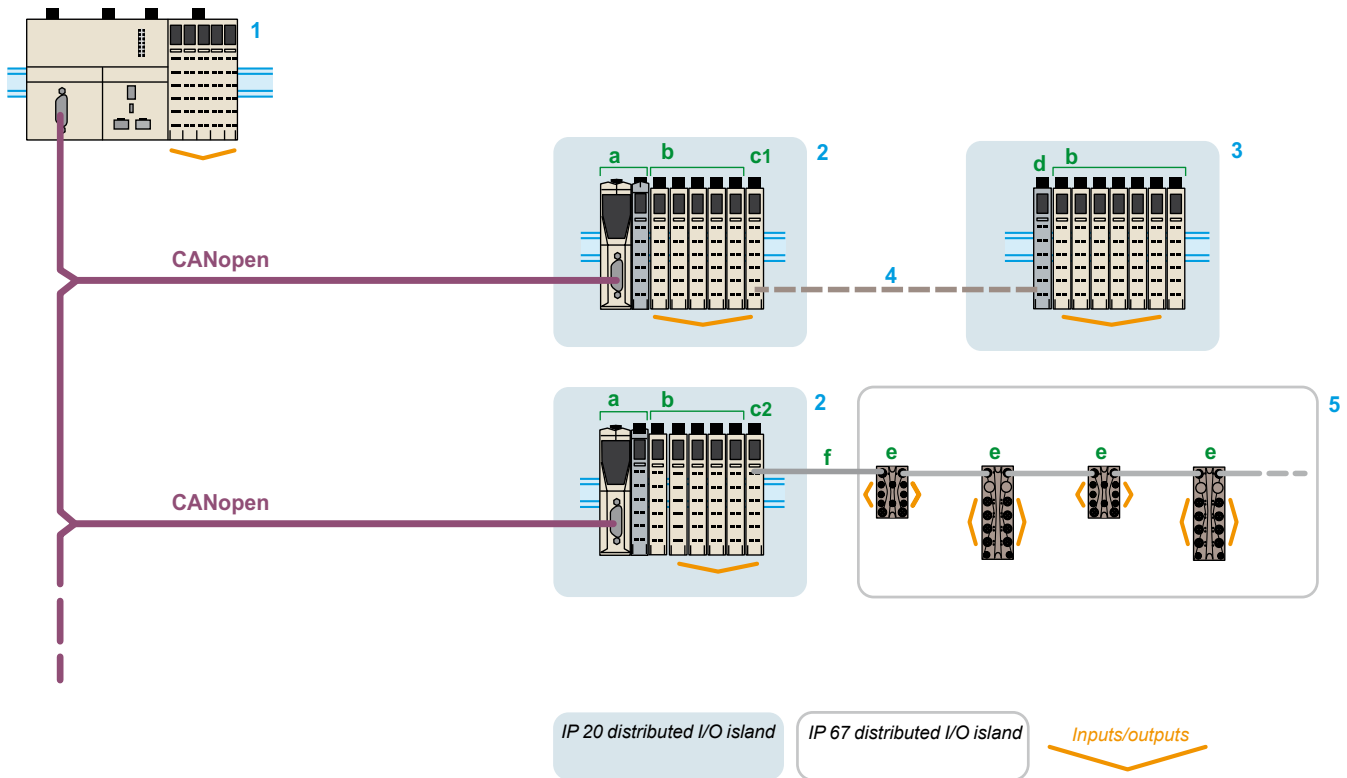

- 1 Modicon LMC058 Motion controller: CANopen bus masters.
- 2 IP 20 distributed I/O islands. Composition: TM5 CANopen interface module (slave) (a) + TM5 compact block (1) or I/O modules (b) (2) + transmitter modules TM5 SBET1 (c1)/TM5 SBET7 (c2) (3).
- 3 IP 20 distributed I/O island. Composition: receiver module TM5 SBER2 (d) + TM5 compact block (1) or TM5 I/O modules (b) (2).
- 4 TM5 expansion bus. Composition: remote I/O connection cable TCS XCNXNX100.
- 5 IP 67 distributed I/O island. Composition: TM7 IP 67 I/O blocks (digital or analog) (e) (4) + expansion bus cable TM7 TCS XCN●●●E (5) (f).

(1) Modicon TM5 Compact block: see page 18.

(2) Modicon TM5 Digital modules: see page 22 ; Modicon TM5 analog modules: see page 30.

(3) Modicon TM5 Transmitter modules and TM5 expansion bus: see page 38.

(4) Modicon TM7 I/O blocks: see page 40.

(5) TM7 expansion bus cables: see page 68.





#### Presentation

The TM5 CANopen interface module offer consists of 4 parts to be ordered separately (1):

- A bus base, TM5 ACBN1 (2)
- A CANopen electronic interface module, TM5 NCO1
- A power distribution electronic module, TM5 SPS3
- A removable terminal block, TM5 ACTB12PS

The modules can be mechanically assembled on the bus base before mounting on a symmetrical rail.

These modules offer the following advantages:

- Removable terminal block
- Spring terminals for connecting the power supply of the interface module and the I/O expansion modules quickly, with no tools required. In addition, the quality of the spring terminals avoids the need for periodic retightening

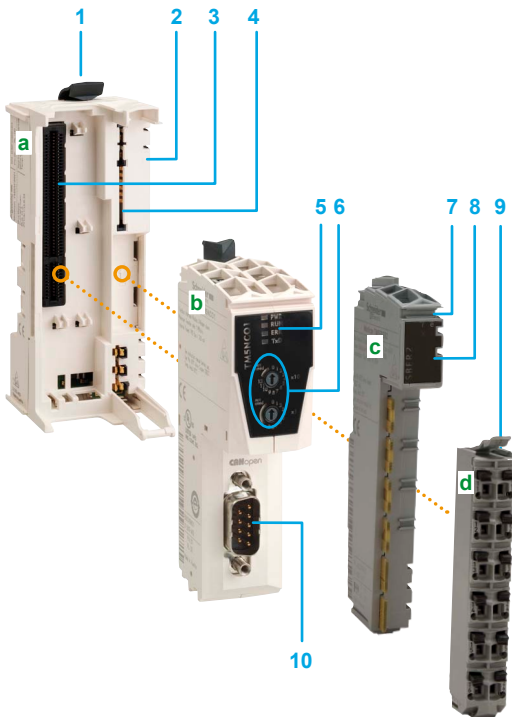

#### Description

The CANopen interface module is a combination of 4 products: A TM5 ACBN1 bus base (a) + a TM5 NCO1 CANopen electronic interface module (b) + a TM5 SPS3 power distribution electronic module (c) (1) + a TM5 ACTB12PS removable terminal block (d).

#### This assembly comprises:

- 1 A mechanical locking lever for mounting/dismounting on a symmetrical rail
- 2 On the side of the base, an expansion bus connection for the link with the next module
- 3 A slot for the CANopen interface module with connector
- 4 A slot for the power distribution module with connector
- 5 A channel and interface module diagnostics LED display block
- 6 Two rotary selector switches for addresses on the bus
- 7 A slot for labelling (label-holder)
- 8 A channel and power distribution module diagnostics LED display block
- 9 A removable spring terminal block with locking clip and slots for coloured identifiers
- 10 A 9-way male SUB-D connector for connecting to the CANopen bus

(1) Also sold in kit, see page 61.

(2) Supplied with 2 protective plates, TM5 ACPL10 and TM5 ACPR10.

### Specifications

<b>Conformity with standards</b>		IEC 61131-2
<b>Product certifications</b>		CE, UL, CSA, GOST-R and c-Tick
<b>Temperature</b>	Operation	Horizontal mounting: - 10...+ 60°C (1) Vertical mounting: - 10...+ 50°C
	Storage	- 40...+ 70°C
<b>Relative humidity</b>		95% max. without condensation
<b>Degree of protection</b>		IP 20 conforming to IEC 61131-2
<b>Degree of pollution</b>		≤ 2 conforming to IEC 60664
<b>Altitude</b>	Operation	0...2000 m
	Storage	0...3000 m
<b>Vibration resistance</b> (mounting on rail)		5...8.4 Hz (3.5 mm fixed amplitude) 8.4...150 Hz (9.8 m/s <sup>2</sup> fixed acceleration)
<b>Shock resistance</b>		147 m/s <sup>2</sup> (15 gn) for 11 ms
<b>Connector</b>	Type	Removable spring terminals
	Number of operations	50 min.

### Electromagnetic compatibility

<b>Electrostatic discharges</b> conforming to EN/IEC 61000-4-2		8 kV: air discharge 4 kV: direct contact
<b>Electromagnetic fields</b> conforming to EN/IEC 61000-4-3		10 V/m (80 MHz...2 GHz) 1 V/m (2...2.7 GHz)
<b>Fast transients</b> conforming to EN/IEC 61000-4-4		Supply: 2 kV I/O: 1 kV Shielded cable: 1 kV (repetition frequency 5 and 100 kHz)
<b>Immunity to overvoltages, 24 V<math>\overline{DC}</math> circuit</b> conforming to EN/IEC 61000-4-5		1 kV in common mode
		0.5 kV in differential mode
<b>Induced magnetic fields</b> conforming to EN/IEC 61000-4-6		10 Vrms (0.15...80 MHz)
<b>Conducted emissions</b> conforming to EN/IEC 55011/CISPR11		150...500 kHz, quasi-peak at 79 dB $\mu$ V
		500 kHz...30 MHz, quasi-peak at 73 dB $\mu$ V
<b>Radiated emissions</b> conforming to EN/IEC 55011/CISPR11		30...230 MHz, 10 m @ 40 dB $\mu$ V/m
		230 MHz...1 GHz, 10 m @ 47 dB $\mu$ V/m

(1) Some devices have an operating temperature which requires a weighting factor between 55° and 60°C and may be subject to other restrictions. Refer to the user guide, which can be downloaded from [www.schneider-electric.com](http://www.schneider-electric.com)

## Modicon LMC058 Motion controller Communication Distributed I/O on CANopen bus with Modicon TM5 (IP 20) interface module



TM5 NCO1



TM5 SPS3



TM5 ACBN1



TM5 ACTB12PS



TM5 ACTLC100



TM5 ACTCH100



TM5 ACLPL10



TM5 ACLPR10



TM5 NCO1K

### References

#### CANopen electronic interface module

Description	Characteristics	Reference	Weight kg
CANopen electronic interface module	CAN bus communication module with CANopen protocol Module colour: white	TM5 NCO1	0.025

#### Power distribution electronic module

Input power supply	Characteristics	Reference	Weight kg
24 V $\overline{\text{---}}$	Power supply for the CANopen bus interface and I/O expansion modules Module colour: grey	TM5 SPS3	0.025

#### Bus base

Power supply	Characteristics	Unit reference	Weight kg
24 V $\overline{\text{---}}$	Use for TM5 NCO1 and TM5 SPS3 electronic modules Supplied with 2 protective plates TM5 ACPL10 and TM5 ACPR10 Colour of the base: white	TM5 ACBN1	0.020

#### Terminal block

Used for	Characteristics	Unit reference	Weight kg
Power distribution electronic module TM5 SPS3	12 spring terminals Terminal block colour: grey	TM5 ACTB12PS	0.016

#### Accessories

Description	Use for	Colour	Sold in lots of	Unit reference	Weight kg
Plain text cover holder (label-holder)	Labelling the I/O channel terminal blocks	Transparent	100	TM5 ACTCH100	0.200
Terminal block shield locking clip (Order with plain text cover holder TM5 ACTCH100)	Locking plain text cover holder TM5 ACTCH100	Transparent	100	TM5 ACTLC100	0.100
Precut sheet of paper labels	Plain text cover holder TM5 ACTCH100	White	100	TM5 ACTLS100	0.100
Coloured plastic identifiers	Labelling 16 connection channel terminals	White	1	TM5 ACLITW1	0.015
		Red	1	TM5 ACLITR1	0.015
		Blue	1	TM5 ACLITB1	0.015
Metal tool	Inserting/removing TM5 ACLIT $\bullet$ 1 identifiers	Black	1	TM5 ACLT1	0.030
Retaining plates for bus bases	Held on the left side	White	10	TM5 ACLPL10	0.004
	Held on the right side	White	10	TM5 ACLPR10	0.004
Locking clips	For electronic modules	Black	100	TM5 ACADL100	0.001

#### Interface module kit

Description	Composition	Reference	Weight kg
Kit including a CANopen electronic interface module, a power distribution electronic module, a bus base and a terminal block	TM5 NCO1 + TM5 SPS3 + TM5 ACBN1 + TM5 ACTB12PS	TM5 NCO1K	0.076

#### Configuration software

- SoMachine software, see page 76.
- Performance distributed I/O configuration software, please consult our site [www.schneider-electric.com](http://www.schneider-electric.com)

(1) Modicon TM5 Transmitter/Receiver modules (see page 38).

# Modicon LMC058 Motion controller

## Communication

Distributed I/O on CANopen bus with Modicon TM7 interface blocks IP 67

**Applications**

**CANopen bus interface with digital I/O**



**Degree of protection**

IP 67	IP 67
-------	-------

**Type of housing**

Plastic	Plastic
---------	---------

**Modularity (number of channels)**

Max. number of digital channels	8 channels configurable as inputs or outputs	16 channels configurable as inputs or outputs
Digital inputs	0...8 according to software configuration	0...16 according to software configuration
Digital outputs	0...8 according to software configuration	0...16 according to software configuration

**Digital inputs**

Voltage/current	24 V $\overline{=}$ /4.4 mA	24 V $\overline{=}$ /4.4 mA
Type	Sink (1)	Sink (1)
IEC 61131-2 conformity	Type 1	Type 1

**Digital outputs**

Voltage	24 V $\overline{=}$	24 V $\overline{=}$
Type	Transistor/Source (2)	Transistor/Source (2)
Current per output	0.5 A max.	0.5 A max.
Current per interface I/O block	4 A max.	4 A max.

**Sensor/actuator power supply**

Voltage	24 V $\overline{=}$	24 V $\overline{=}$
Max. current	500 mA for all channels	500 mA for all channels
Protection against	Overloads, short-circuits and reverse polarity	Overloads, short-circuits and reverse polarity

**Connection**

CANopen bus	Bus input connector	A-coded 5-way male M12	A-coded 5-way male M12
	Bus output connector	–	A-coded 5-way female M12
TM7 expansion bus	Bus input connector	–	–
	Bus output connector	B-coded 4-way female M12	B-coded 4-way female M12
Digital I/O channels	Sensor connector	3-way female M8, 1 channel per connector	3-way female M8, 1 channel per connector
	Actuator connector	3-way female M8, 1 channel per connector	3-way female M8, 1 channel per connector
Interface I/O block power supply	Input connector	4-way male M8	4-way male M8
	Output connector	4-way female M8	4-way female M8

**Diagnostics**

By interface I/O block	Yes	Yes
By channel	Yes	Yes
By communication	On CANopen bus	Yes
	On TM7 bus	Yes

**Type of CANopen interface I/O block**

<b>TM7 NCOM08B</b>	<b>TM7 NCOM16B</b>
--------------------	--------------------

**Pages**

67	67
----	----

(1) Sink inputs: positive logic  
 (2) Source outputs: positive logic





IP 67
Plastic
16 channels configurable as inputs or outputs
0...16 according to software configuration
0...16 according to software configuration
24 V $\overline{\text{---}}$ /4.4 mA
Sink (1)
Type 1
24 V $\overline{\text{---}}$
Transistor/Source (2)
0.5 A max.
4 A max.
24 V $\overline{\text{---}}$
500 mA for all channels
Overloads, short-circuits and reverse polarity
A-coded 5-way male M12
A-coded 5-way female M12
-
B-coded 4-way female M12
A-coded 5-way female M12, 2 channels per connector
A-coded 5-way female M12, 2 channels per connector
4-way male M8
4-way female M8
Yes
Yes
Yes
Yes

**TM7 NCOM16A**

67

# Modicon LMC058 Motion controller

## Communication

Distributed I/O on CANopen bus with Modicon TM7 interface blocks IP 67

### Presentation

To enhance its "Flexible machine Control" concept, a key component of MachineStruxure™, Schneider Electric offers Modicon TM7 IP 67 blocks for mounting outside electrical cabinets, directly on the installation. The IP 67 protection of these blocks enables them to be used within processes or machines in harsh environments (splashing water, oil, dust, etc.).

They have the following characteristics:

- Dust and damp proof
- Robust and compact
- Rapid wiring, economical to use

The CANopen interface I/O blocks enable sensors and actuators distributed over machines to be connected via the CANopen fieldbus. These interface I/O blocks communicate on the bus. They have one part for connecting sensors and actuators using M8 or M12 connectors and one part for connection to the CANopen fieldbus.

The interface I/O block offer comprises IP 67 blocks that connect to a CANopen bus and have digital channels that can be configured as inputs or outputs, including:

- A CANopen interface block with 8 configurable I/O for connection via M8 connector
- Two CANopen interface blocks with 16 configurable I/O

This offer is completed with :

- Digital I/O expansion blocks, see page 40
- Analog input expansion blocks, see page 40
- Power distribution block, see page 40
- Connection accessories, see page 70

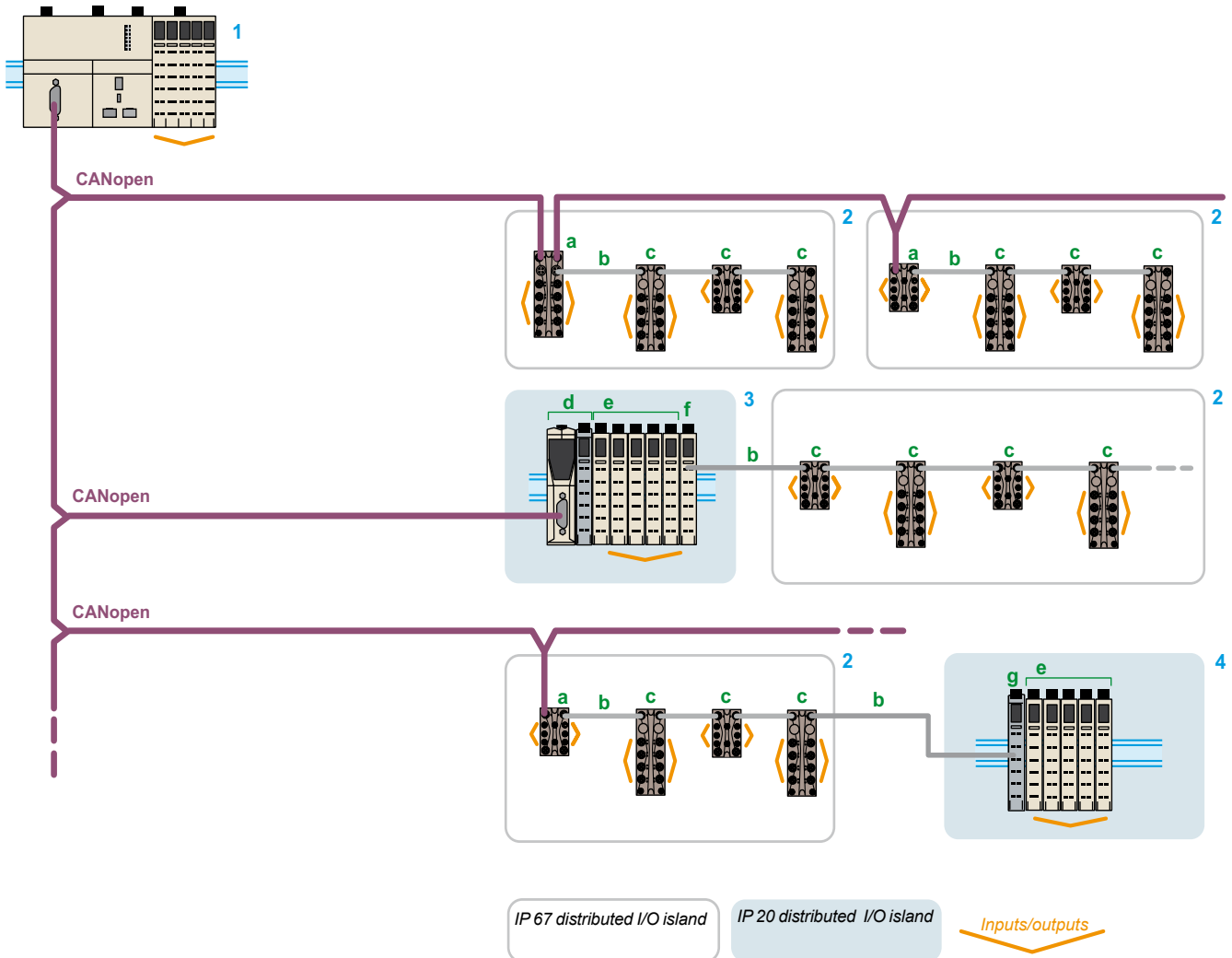

- 1 Modicon LMC058 motion controller: CANopen bus masters.
- 2 IP 67 distributed I/O islands. Composition: TM7 CANopen interface block (slave) with digital I/O (a) + TM7 expansion bus cable (b) + TM7 digital/analog blocks (c) (1).
- 3 IP 20 distributed I/O island. Composition: TM5 CANopen interface module (slave) (d) + TM5 compact (2) or TM5 modules (e) (3) + transmitter module TM5SBET7 (f) (4).
- 4 IP 20 distributed I/O island. Composition: receiver module TM5SBER2 (g) (4) + TM5 modules (e) (3).

(1) Modicon TM7 Digital or analog block, see page 40

(2) Modicon TM5 compact blocks, see page 18

(3) Modicon TM5 digital modules, see page 22. Modicon TM5 analog modules, see page 30.

(4) Modicon TM5 transmitter and receiver modules, see page 38.

# Modicon LMC058 Motion controller

## Communication

Distributed I/O on CANopen bus with Modicon TM7 interface blocks IP 67



CANopen interface block with digital I/O



Communication bus status LED  
Channel status LED  
Power supply status LED

### Diagnostics functions

The diagnostic monitoring of faults is indicated by LEDs on CANopen interface I/O blocks, expansion blocks and power distribution blocks and informs the control system (LMC058 motion controller) via the TM7 bus.

Each Modicon TM7 block has LEDs

- To display the status of the TM7 bus, the channel and the power supply
- For quick, precise location of a fault

There are several levels of diagnostics:

- Diagnostics per channel:
  - State of inputs
  - State of outputs
- Communication bus diagnostics:
  - On CAN bus (CANopen interface I/O block)
  - On TM7 expansion bus (CANopen interface I/O block and I/O expansion blocks).

### Specifications

<b>Conformity with standards</b>	IEC 61131-2
<b>Product certifications</b>	CE, cURus, GOST-R and c-Tick, ATEX (II 3g EEx nA II T5, IP 67, Ta = 0...60°C)
<b>Temperature</b>	Operation: -10...+60°C (14...140°F) Storage: -25...+85°C (-13...185°F)
<b>Relative humidity</b>	5...95% (without condensation)
<b>Degree of pollution</b> conforming to IEC 60664	2
<b>Degree of protection</b> conforming to IEC 61131-2	IP 67
<b>Altitude</b>	Operation: 0...2000 m (0...6560 ft.) (1) Storage: 0...3000 m (0...9842 ft.)
<b>Vibration resistance</b> conforming to IEC 60721-3-5 Class 5M3	DIN rail mounted 7.5 mm (0.295 in.) 2...8 Hz fixed amplitude 20 m/s <sup>2</sup> (2 gn) 8...200 Hz fixed acceleration 40 m/s <sup>2</sup> (4 gn) 200...500 Hz fixed acceleration
<b>Shock resistance</b> conforming to IEC 60721-3-5 Class 5M3	300 m/s <sup>2</sup> (30 gn) for 11 ms, 1/2 sine wave, type 1 shock
<b>Connectors</b>	Type: M8 and/or M12 Number of operations: 50 min.

### Electromagnetic compatibility

<b>Electrostatic discharges</b> conforming to IEC/EN 61000-4-2	± 8 kV, criterion B (air discharge) ± 4 kV, criterion B (direct discharge)
<b>Electromagnetic fields</b> conforming to IEC/EN 61000-4-3	10 V/m, amplitude modulation 80% at 1 kHz (80 MHz...2 GHz) 1 V/m (2...2.7 GHz)
<b>Fast transients</b> conforming to IEC/EN 61000-4-4	Supply: 2 kV, criterion B I/O: 1 kV, criterion B Shielded cable: 1 kV, criterion B Repetition frequency: 5 and 100 kHz
<b>Immunity to overvoltages, 24 V <math>\overline{\text{---}}</math> circuit</b> conforming to IEC/EN 61000-4-5	Supply: □ 1 kV (12 Ω), criterion B in common mode □ 0.5 kV (2 Ω), criterion B in differential mode Unshielded links: □ 1 kV (42 Ω), criterion B in common mode □ 0.5 kV (42 Ω), criterion B in differential mode Shielded links: □ 1 kV (12 Ω), criterion B in common mode □ 0.5 kV (2 Ω), criterion B in differential mode
<b>Induced magnetic fields</b> conforming to IEC/EN 61000-4-6	Line supply, I/O signal connections > 10 m (32.8 ft.) Functional earth connection: 10 Vrms, criterion A, amplitude modulation 80% at 1 kHz (150...80 MHz)
<b>Conducted emissions</b> conforming to EN 55011 (IEC/CISPR11)	150...500 kHz, peak 79 dB μV 500 kHz...30 MHz, peak 73 dB μV
<b>Radiated emissions</b> conforming to EN 55011 (IEC/CISPR11)	30...230 MHz, 10 m (32.8 ft) at 40 dB (μV/m) 230 MHz...1 GHz, 10 m (32.8 ft) at 47 dB (μV/m)

(1) Temperature reduction of 0.5°C (32.9°F) for every additional 100 m (328 ft.) altitude above 2000 m (6560 ft.). Refer to the instruction sheet for each product, downloadable from [www.schneider-electric.com](http://www.schneider-electric.com)



## Modicon LMC058 Motion controller Communication

Distributed I/O on CANopen bus with Modicon TM7 interface blocks IP 67

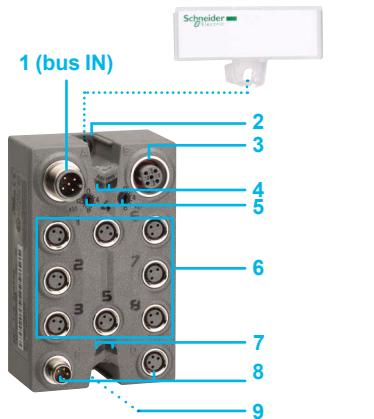

### Description

#### CANopen interface I/O blocks

CANopen **8-channel** interface I/O blocks have the following on the front panel:

- 1 A male M12 connector (bus IN) for connecting the CANopen bus
- 2 A slot for the interface I/O block label (1)
- 3 A female M12 connector for connecting the TM7 expansion bus
- 4 Two bus diagnostic LEDs
- 5 CANopen address settings rotary switches
- 6 Eight female M8 connectors for connecting sensors and actuators with eight LEDs for indicating channel status
- 7 Two LEDs indicating the status of the sensor and actuator 24 V  $\overline{\text{DC}}$  power supplies
- 8 Two M8 connectors for connecting the 24 V  $\overline{\text{DC}}$  sensor and actuator power supplies: male for PWR IN, female for PWR OUT
- 9 Fixing using two  $\varnothing$  4 screws (not supplied) and connection of the functional earth when fixing the block on a metal support

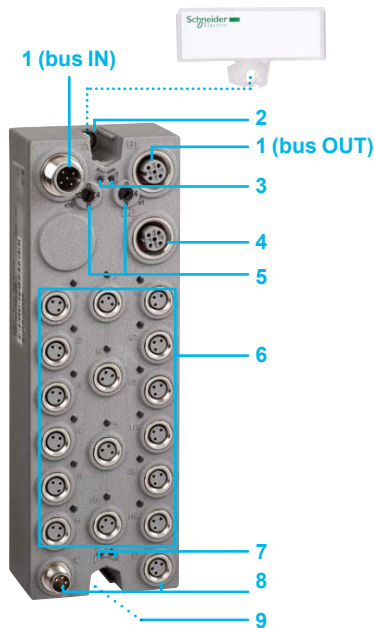

CANopen **16-channel** interface I/O blocks have the following on the front panel:

- 1 A male M12 connector (bus IN) and a female M12 connector (bus OUT) for connecting the CANopen bus
- 2 A slot for the interface I/O block label (1)
- 3 Two bus diagnostic LEDs
- 4 A female M12 connector for connecting the TM7 expansion bus
- 5 CANopen address settings rotary switches
- 6 Eight M12 connectors (2 channels per connector) or sixteen M8 connectors for connecting sensors and actuators with LEDs for indicating channel status
- 7 Two LEDs indicating the status of the sensor and actuator 24 V  $\overline{\text{DC}}$  power supplies
- 8 Two M8 connectors for connecting the 24 V  $\overline{\text{DC}}$  sensor and actuator power supplies: male for PWR IN, female for PWR OUT
- 9 Fixing using two  $\varnothing$  4 screws (not supplied) and connection of the functional earth when fixing the block on a metal support

(1) Label-holder supplied with IP 67 block

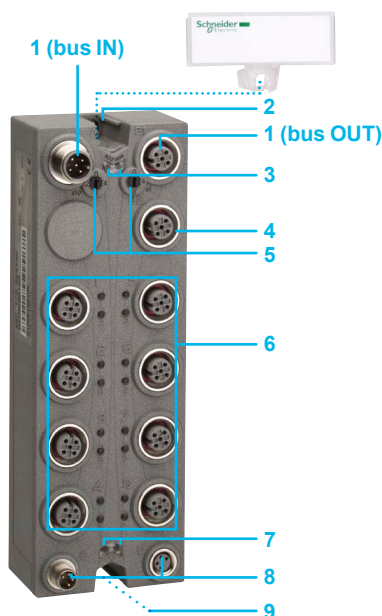



# Modicon LMC058 Motion controller

## Communication

Distributed I/O on CANopen bus with Modicon TM7 interface blocks IP 67



TM7 NCOM08B



TM7 NCOM16B



TM7 NCOM16A

### Modicon TM7 CANopen interface blocks with digital I/O

Max. no. of channels	Number, type of inputs	Number, type of outputs	Sensor/actuator connection	Communication bus	Reference	Weight kg
8 I/O	8, sink (1)	8, transistor/ source (2)	8 female M8 connectors	CANopen, TM7 bus	<b>TM7 NCOM08B</b>	0.195
16 I/O	16, sink (1)	16, transistor/ source (2)	16 female M8 connectors	CANopen, TM7 bus	<b>TM7 NCOM16B</b>	0.320
	16, sink (1)	16, transistor/ source (2)	8 female M12 connectors	CANopen, TM7 bus	<b>TM7 NCOM16A</b>	0.320

(1) Sink inputs: positive logic  
 (2) Source outputs: positive logic

#### Architecture, connecting cables

See page 68

#### Modicon TM7 I/O expansion blocks

See page 40

#### Connection accessories

See page 70

#### Separate parts

See page 71

#### Configuration software

- SoMachine software, see page 76.
- Performance distributed I/O configuration software, please consult our site [www.schneider-electric.com](http://www.schneider-electric.com)

### CANopen architecture

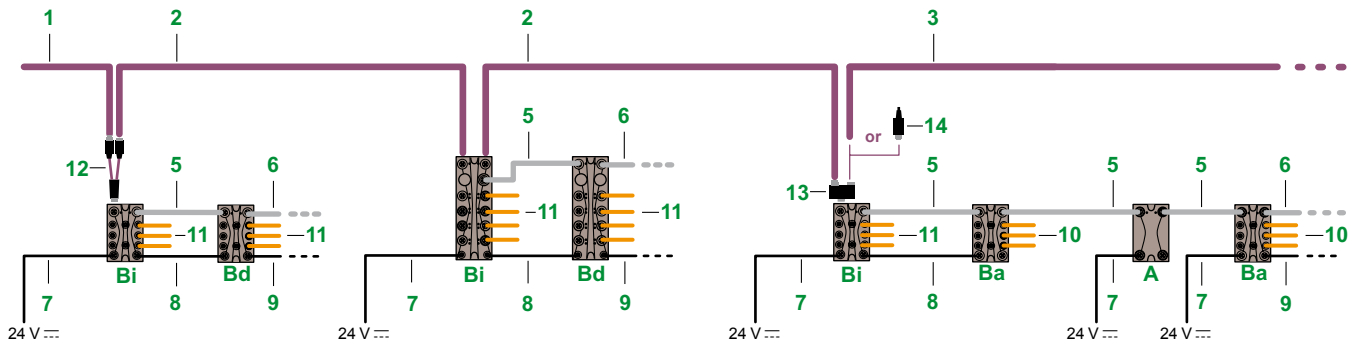

### TM7 expansion bus architecture

TM5 NCO1 + TM5 SBET7

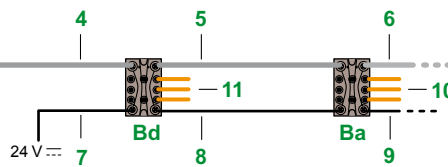
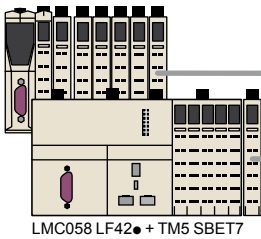

- A** Power distribution block
- Ba** Analog I/O expansion block
- Bd** Digital I/O expansion block
- Bi** CANopen interface I/O block

### References

#### Cables for connection to the CANopen bus

Designation	Description	Item no.	Length (m)	Reference	Weight kg
CANopen bus connection cables (bus IN)	Equipped with one A-coded 5-way angled female M12 connector and 1 flying lead	1	1	TCS CCN2FNX1SA	0.089
		3	TCS CCN2FNX3SA	0.195	
		10	TCS CCN2FNX10SA	0.563	
		25	TCS CCN2FNX25SA	1.352	
		1	TCS CCN1FNX1SA	0.089	
	Equipped with one A-coded 5-way straight female M12 connector and 1 flying lead	1	TCS CCN2M2F1	0.127	
		2	TCS CCN2M2F2	0.179	
		5	TCS CCN2M2F5	0.337	
		10	TCS CCN2M2F10	0.600	
		15	TCS CCN2M2F15	0.863	
CANopen bus daisy chain cables	Equipped with two A-coded 5-way angled M12 connectors, 1 male and 1 female, at each end	2	0.3	TCS CCN2M2F03	0.090
		1	TCS CCN2M2F1	0.127	
		2	TCS CCN2M2F2	0.179	
		5	TCS CCN2M2F5	0.337	
		10	TCS CCN2M2F10	0.600	
	Equipped with two A-coded 5-way straight M12 connectors, 1 male and 1 female, at each end	2	0.3	TCS CCN1M1F03	0.090
		1	TCS CCN1M1F1	0.127	
		2	TCS CCN1M1F2	0.179	
		5	TCS CCN1M1F5	0.337	
		10	TCS CCN1M1F10	0.600	
CANopen bus connection cables (bus OUT)	Equipped with one A-coded 5-way angled male M12 connector and 1 flying lead	3	1	TCS CCN2MNX1SA	0.089
		3	TCS CCN2MNX3SA	0.195	
		10	TCS CCN2MNX10SA	0.563	
		25	TCS CCN2MNX25SA	1.352	
		3	TCS CCN1MNX1SA	0.089	
	Equipped with one A-coded 5-way straight male M12 connector and 1 flying lead	3	1	TCS CCN1MNX1SA	0.089
		3	TCS CCN1MNX3SA	0.195	
		10	TCS CCN1MNX10SA	0.563	
		25	TCS CCN1MNX25SA	1.352	

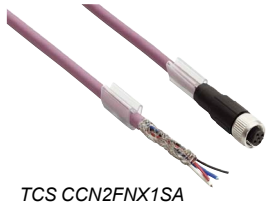

#### TM7 expansion bus cables

TM7 expansion bus cables (bus IN)	Equipped with one B-coded 4-way angled female M12 connector and 1 flying lead	4	1	TCS XCN2FNX1E	0.089
		3	TCS XCN2FNX3E	0.195	
		10	TCS XCN2FNX10E	0.563	
		25	TCS XCN2FNX25E	1.352	
		4	1	TCS XCN1FNX1E	0.089
Equipped with one B-coded 4-way straight female M12 connector and 1 flying lead	4	1	TCS XCN1FNX1E	0.089	
	3	TCS XCN1FNX3E	0.195		
	10	TCS XCN1FNX10E	0.563		
	25	TCS XCN1FNX25E	1.352		

# Modicon LMC058 Motion controller

## Communication

### Distributed I/O on CANopen bus with Modicon TM7 interface blocks IP 67

#### Connection accessories (continued)

Designation	Description	Item no.	Length (m)	Reference	Weight kg		
<b>TM7 expansion bus cables (continued)</b>							
<b>TM7 bus daisy chain cables</b>	Equipped with two B-coded 4-way angled M12 connectors, 1 male and 1 female, at each end	5	0.3	TCS XCN2M2F03E	0.090		
			1	TCS XCN2M2F1E	0.127		
			2	TCS XCN2M2F2E	0.179		
			5	TCS XCN2M2F5E	0.337		
			10	TCS XCN2M2F10E	0.600		
		15	TCS XCN2M2F15E	0.863			
	Equipped with two B-coded 4-way straight M12 connectors, 1 male and 1 female, at each end	5	0.3	TCS XCN1M1F03E	0.090		
			1	TCS XCN1M1F1E	0.127		
			2	TCS XCN1M1F2E	0.179		
			5	TCS XCN1M1F5E	0.337		
			10	TCS XCN1M1F10E	0.600		
			15	TCS XCN1M1F15E	0.863		
		<b>TM7 expansion bus cables (bus OUT)</b>	Equipped with one B-coded 4-way angled male M12 connector and 1 flying lead	6	1	TCS XCN2MNX1E	0.089
					3	TCS XCN2MNX3E	0.195
					10	TCS XCN2MNX10E	0.563
				25	TCS XCN2MNX25E	1.352	
Equipped with one B-coded 4-way straight male M12 connector and 1 flying lead	6			1	TCS XCN1MNX1E	0.089	
			3	TCS XCN1MNX3E	0.195		
			10	TCS XCN1MNX10E	0.563		
			25	TCS XCN1MNX25E	1.352		
	<b>Power distribution cables</b>						
	<b>Power IN power distribution cables</b>		Equipped with one 4-way angled female M8 connector and 1 flying lead	7	1	TCS XCNEFNX1V	0.041
					3	TCS XCNEFNX3V	0.105
					10	TCS XCNEFNX10V	0.329
					25	TCS XCNEFNX25V	0.809
				Equipped with one 4-way straight female M8 connector and 1 flying lead	7	1	TCS XCNDFNX1V
			3		TCS XCNDFNX3V	0.105	
		10	TCS XCNDFNX10V		0.329		
		25	TCS XCNDFNX25V		0.809		
<b>Power daisy chain cables</b>		Equipped with two 4-way angled M8 connectors, 1 male and 1 female, at each end	8		0.3	TCS XCNEMEF03V	0.028
				1	TCS XCNEMEF1V	0.050	
			2	TCS XCNEMEF2V	0.082		
			5	TCS XCNEMEF5V	0.178		
			10	TCS XCNEMEF10V	0.338		
			15	TCS XCNEMEF15V	0.498		
	Equipped with two 4-way straight M8 connectors, 1 male and 1 female, at each end		8	0.3	TCS XCNDMDF03V	0.105	
				1	TCS XCNDMDF1V	0.329	
				2	TCS XCNDMDF2V	0.809	
				5	TCS XCNDMDF5V	0.105	
			10	TCS XCNDMDF10V	0.329		
		15	TCS XCNDMDF15V	0.809			
	<b>Power OUT power distribution cables</b>	Equipped with one 4-way angled male M8 connector and 1 flying lead	9	1	TCS XCNEYNX1V	0.041	
				3	TCS XCNEYNX3V	0.105	
				10	TCS XCNEYNX10V	0.329	
			25	TCS XCNEYNX25V	0.809		
Equipped with one 4-way straight male M8 connector and 1 flying lead			9	1	TCS XCNDMNX1V	0.041	
			3	TCS XCNDMNX3V	0.105		
			10	TCS XCNDMNX10V	0.329		
			25	TCS XCNDMNX25V	0.809		
		<b>Cables for connecting analog sensors and actuators</b>					
<b>Cables for connecting sensors and actuators</b>		Equipped with one A-coded 5-way angled male M12 connector and 1 flying lead	10	2	TCS XCN2M2SA	0.143	
			5	TCS XCN2M5SA	0.258		
			15	TCS XCN2M15SA	0.546		
	Equipped with one A-coded 5-way straight male M12 connector and 1 flying lead	10	2	TCS XCN1M2SA	0.143		
			5	TCS XCN1M5SA	0.258		
			15	TCS XCN1M15SA	0.546		
<b>Cables for connecting digital sensors and actuators</b>							
Please consult our "Detection for OsiSense automation solutions" catalogue		11					
<b>Accessories</b>							
See next page		12					
		13					
		14					



TCS XCN1M1F●●E



TCS XCN1MNX●●E



TCS XCNEFNX●●V



TCS XCNDMDF●●V



TCS XCNEYNX●●V



TCS XCN1M●●SA

# Modicon LMC058 Motion controller

## Communication

Distributed I/O on CANopen bus with Modicon TM7 interface blocks IP 67



TM7 ACYCJ



TM7 ACYC



TM7 ACTHA

### Connection accessories

Description	Composition	Item no.	Reference	Weight kg
CAN bus Y cable	Equipped with 2x5-way M12 connectors, 1 male and 1 female, and at the other end: 1x5-way male M12 connector	12	TM7 ACYCJ	0.031
CAN Y connector	For connecting 2xM12 connectors, 1 male and 1 female, to male M12 connector on the expansion block	13	TM7 ACYC	0.100
Line terminator (for end of bus)	Equipped with 1x5-way male M12 connector	14	TM7 ACTLA	0.023
Connector with temperature probe for measurement by thermocouple (1)	Equipped with 1x5-way male M12 connector	–	TM7 ACTHA	0.100

(1) For use with the **TM7 BAI4PLA** expansion block for measurement with compensation of the temperature of the connector.

# Modicon LMC058 Motion controller

## Communication

Distributed I/O on CANopen bus with Modicon TM7 interface blocks IP 67



TM7 ACMP

### Separate parts

Description	Composition	Unit reference	Weight kg
Sealing plugs (1)	For M8 connector for Modicon TM7 IP 67 blocks <b>Lot of 50</b>	<b>TM7 ACCB</b>	0.100
	For M12 connector for Modicon TM7 IP 67 blocks <b>Lot of 50</b>	<b>TM7 ACCA</b>	0.100
Mounting plate on symmetrical DIN rail	For Modicon TM7 IP 67 blocks	<b>TM7 ACMP</b>	0.020
	For Modicon TM7 IP 67 blocks <b>Lot of 10</b>	<b>TM7 ACMP10</b>	0.200
Set of two screwdrivers	For tightening the rings on M8 and M12 connectors to the correct torque	<b>TM7 ACTW</b>	0.198

(1) The use of sealing plugs ensures that unused connectors on Modicon TM7 IP 67 blocks have IP 67 protection.

#### CANopen Performance architecture

Example of connection of a CANopen Performance architecture dedicated to machines and modular installations.

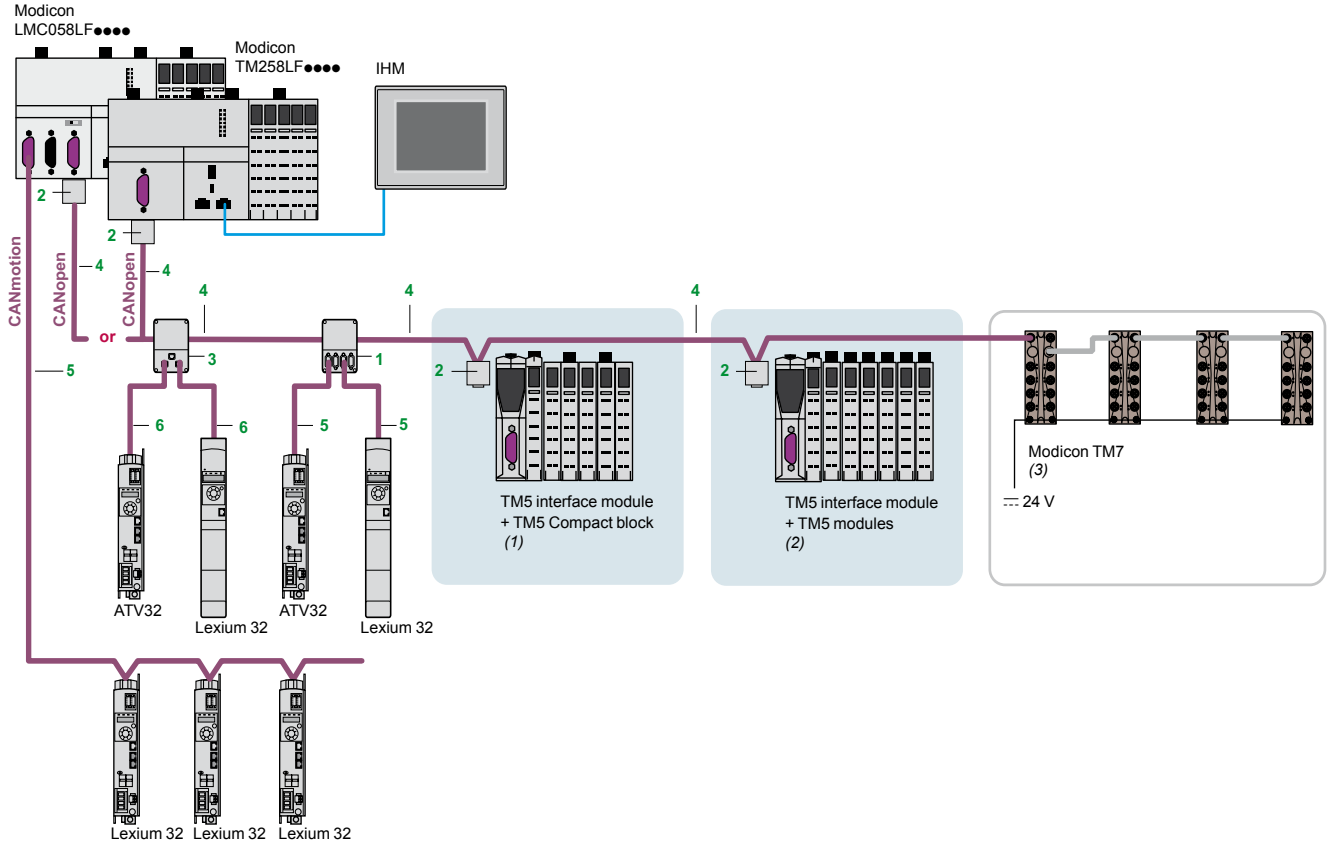

#### References

##### Standard tap junctions and connectors

Designation	Description	Item no.	Length	Reference	Weight kg
<b>IP 20 CANopen tap junction</b>	4 SUB-D ports. Screw terminal block for connecting the trunk cables Line termination	<b>1</b>	–	<b>TSX CANTDM4</b>	0.196
<b>IP 20 connectors</b> CANopen 9-way female SUB-D. Switch for line termination	90° angled	<b>2</b>	–	<b>TSX CANKCDF90T</b>	0.046
	Straight (4)	–	–	<b>TSX CANKCDF180T</b>	0.049
	90° angled with 9-way SUB-D for connecting a PC or diagnostic tool	–	–	<b>TSX CANKCDF90TP</b>	0.051
<b>IP 20 CANopen tap junction for Altivar and Lexium</b>	2 RJ45 ports	<b>3</b>	–	<b>VW3 CANTAP2</b>	0.250

- (1) Modicon TM5 interface module (see page 58) + Modicon TM5 Compacts blocks (see page 18).  
 (2) Modicon TM5 interface module (see page 58) + Modicon TM5 modules: Digital modules (see page 22) ; Analog modules (see page 30) ; Expert module (see page 34).  
 (3) Modicon TM7 offer: TM7 IP 67 I/O blocks, expansion cable, and accessories (see page 40).  
 (4) For connection to Altivar IMC integrated controller card.



TSX CAN TDM4

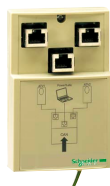

VW3 CAN TAP2



TSX CAN KCD F90T



TSX CAN KCD F180T



TSX CAN KCD F90TP

References (continued)							
IP 20 standard cables and preassembled cordsets							
Designation	Description	Item no.	Length	Reference	Weight kg		
<b>CANopen cables</b> (2 x AWG 22 2 x AWG 24)	For standard environment (1), CE marking: low smoke. Zero halogen. Flame-retardant (IEC 60332-1)	4	50 m	<b>TSX CAN CA50</b>	4.930		
			100 m	<b>TSX CAN CA100</b>	8.800		
			300 m	<b>TSX CAN CA300</b>	24.560		
	For standard environment (1), UL certification, CE marking: flame- retardant (IEC 60332-2)	4	50 m	<b>TSX CAN CB50</b>	3.580		
			100 m	<b>TSX CAN CB100</b>	7.840		
			300 m	<b>TSX CAN CB300</b>	21.870		
	For harsh environments (1) or mobile installations, CE marking: low smoke. Zero halogen. Flame-retardant (IEC 60332-1). Oil-resistant	4	50 m	<b>TSX CAN CD50</b>	3.510		
			100 m	<b>TSX CAN CD100</b>	7.770		
			300 m	<b>TSX CAN CD300</b>	21.700		
<b>CANopen preassembled cordsets</b> One 9-way female SUB-D connector at each end.	For standard environment (1), CE marking: low smoke. Zero halogen. Flame-retardant (IEC 60332-1)	-	0.3 m	<b>TSX CAN CADD03</b>	0.091		
			1 m	<b>TSX CAN CADD1</b>	0.143		
			3 m	<b>TSX CAN CADD3</b>	0.295		
			5 m	<b>TSX CAN CADD5</b>	0.440		
	For standard environment (1), UL certification, CE marking: flame- retardant (IEC 60332-2)	-	0.3 m	<b>TSX CAN CBDD03</b>	0.086		
			1 m	<b>TSX CAN CBDD1</b>	0.131		
			3 m	<b>TSX CAN CBDD3</b>	0.268		
			5 m	<b>TSX CAN CBDD5</b>	0.400		
	<b>CANopen preassembled cordsets</b>	Cordsets with one 9-way female SUB-D connector and one RJ45 connector	5	0.5 m	<b>TCS CCN 4F3M05T</b>	0.100	
				1 m	<b>TCS CCN 4F3M1T</b>	0.100	
					<b>VW3 M38 05R010 (2)</b>	0.100	
		Cordsets with two 9-way SUB-D connectors, one female and one male	-	0.5 m	<b>TLA CDCBA005</b>	0.100	
1.5 m				<b>TLA CDCBA015</b>	0.120		
3 m				<b>TLA CDCBA030</b>	0.190		
			5 m	<b>TLA CDCBA050</b>	0.350		
<b>IP 20 connection accessories</b>							
<b>CANopen connector for Altivar 71 (3)</b>	9-way female SUB-D Switch for line termination. Cables exit at 180°	-	-	<b>VW3 CAN KCDF180T</b>	0.100		
<b>Adaptor for Altivar 71 drive</b>	SUB-D to RJ45 CANopen adaptor	-	-	<b>VW3 CANA71</b>	0.100		
<b>CANopen preassembled cordsets</b>	1 RJ45 connector at each end	6	0.3 m	<b>VW3 CANCERR03</b>	0.100		
			1 m	<b>VW3 CANCERR1</b>	0.100		
<b>CANopen bus adaptor for Lexium 17D</b>	Hardware interface for CANopen- compliant link + 1 connector for a PC terminal	-	-	<b>AM0 2CA001V000</b>	0.110		
<b>Y-connector</b>	CANopen/Modbus	-	-	<b>TCS CTN011M11F</b>	0.100		
<b>IP 67 cables and preassembled cordsets, IP 67 connection accessories for Modicon TM7 blocks</b> (see page 68)							



VW3 CAN A71



AM0 2CA 001V000

(1) Standard environment: no particular environmental constraints, operating temperature between +5°C and +60°C, and in fixed installations

Harsh environment: resistance to hydrocarbons, industrial oils, detergents, solder splashes, relative humidity up to 100%, saline atmosphere, significant temperature variations, operating temperature between -10°C and +70°C, or in mobile installations.

(2) Cordset equipped with a line terminator.

(3) For ATV 71H●●M3, ATV 71HD11M3X, HD15M3X, ATV 71H075N4... HD18N4 drives, this connector can be replaced by the TSX CAN KCDF 180T connector.

Ethernet

Ethernet Modbus/TCP or Ethernet IP network architecture

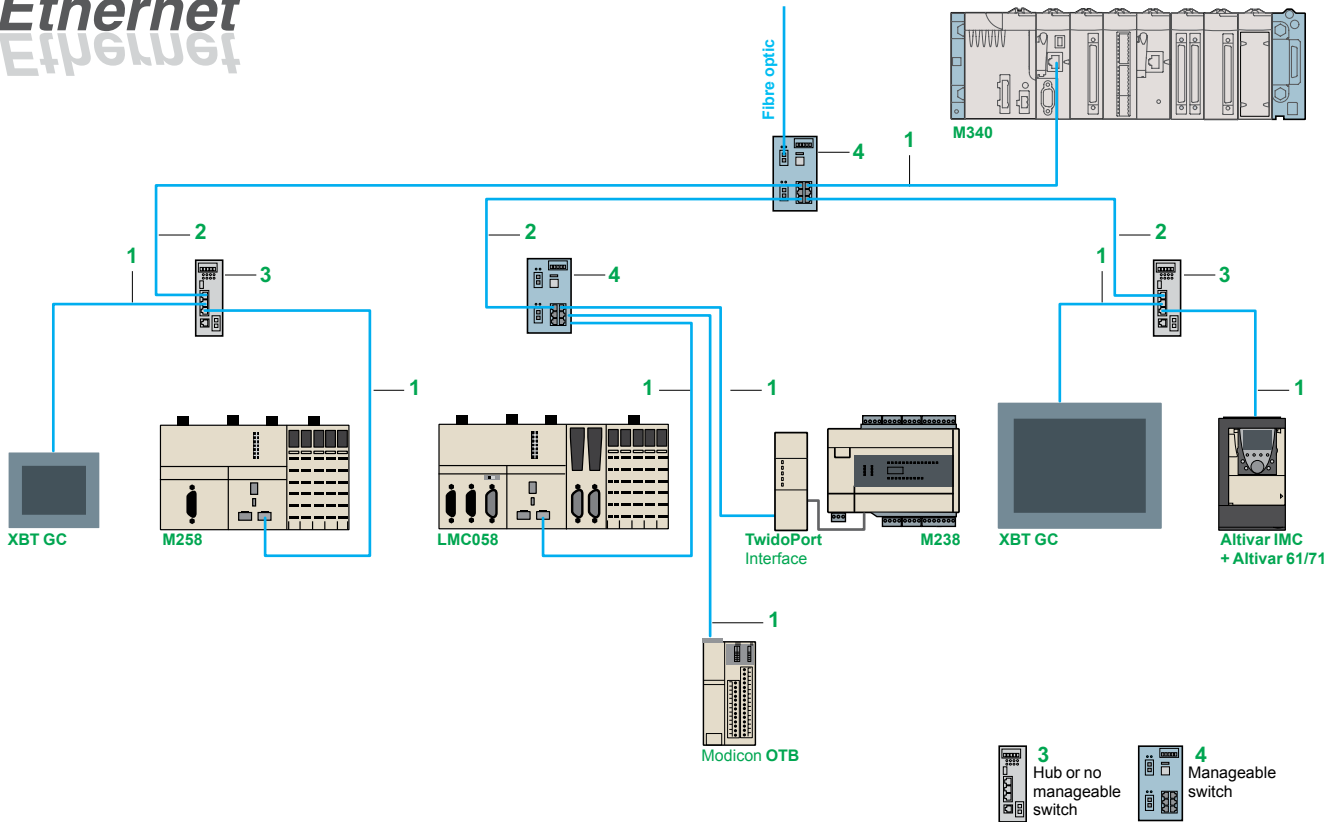

References (1)

Shielded copper connection cables

ConneXium shielded copper connection cables are available in two versions to comply with the different standards and approvals in force:

■ Shielded twisted pair copper cables to standard EIA/TIA 568

- These cables conform to:
- standard EIA/TIA 568, category CAT 5E,
  - standard IEC 11801/EN 50173, class D.
- Their flame resistance conforms to:
- NFC 32070# classification C2
  - standards IEC 322/1,
  - Low Smoke Zero Halogen (LSZH).

■ Shielded twisted pair copper cables, UL and CSA 22.1 approved

- These cables conform to:
- standards UL and CSA 22.1.
- Their flame resistance conforms to NFPA 70.

“Do It Yourself” cable and connectors

The ConneXium “Do It Yourself” range allows the user to make up Ethernet copper cables on site and to the required length. They are designed for cabling Ethernet 10/100 Mbit/s networks. The maximum length of cables made up in this way is 80 m. They can be assembled quickly using a knife and cutting pliers (no special tools are required).

Description	Characteristics	Length	Reference	Weight kg
<b>Ethernet copper cable</b> 2 shielded twisted pairs 24 AWG	Conforming to the above-mentioned standards and approvals	300 m 984.252 ft	<b>TCSECN300R2</b>	–
<b>RJ 45 connector</b>	Conforming to EIA/TIA-568-D	–	<b>TCSEK3MDS</b>	–
<b>M12 connector</b>	Conforming to IEC 60176-2-101	–	<b>TCSEK1MDRS</b>	–

(1) Other versions (fibre optic, switches, ...): please consult our site [www.schneider-electric.com](http://www.schneider-electric.com)



**References (continued)**

**Shielded twisted pair cables to standard EIA/TIA568**

Description	Pre-formed at both ends	Item	Length	Reference	Weight kg lb
<b>Straight cables</b>	2 x RJ45 connectors For connection to terminal equipment (DTE)	1	2 m (6.562 ft)	490NTW00002	—
			5 m (16.404 ft)	490NTW00005	—
			12 m (39.370 ft)	490NTW00012	—
			40 m (131.234 ft)	490NTW00040	—
			80 m (262.467 ft)	490NTW00080	—
<b>Crossover cables</b>	2 x RJ45 connectors For connection between hubs, switches and transceivers	2	5 m (16.404 ft)	490NTC00005	—
			12 m (39.370 ft)	490NTC00015	—
			40 m (131.234 ft)	490NTC00040	—
			80 m (262.467 ft)	490NTC00080	—



490 NT●000●●

**Shielded twisted pair cables, UL and CSA 22.1 approved**

Description	Pre-formed at both ends	Item	Length	Reference	Weight kg lb
<b>Straight cables</b>	2 x RJ45 connectors For connection to terminal equipment (DTE)	1	2 m (6.562 ft)	490NTW00002U	—
			5 m (16.404 ft)	490NTW00005U	—
			12 m (39.370 ft)	490NTW00012U	—
			40 m (131.234 ft)	490NTW00040U	—
			80 m (262.467 ft)	490NTW00080U	—
<b>Crossover cables</b>	2 x RJ45 connectors For connection between hubs, switches and transceivers	2	5 m (16.404 ft)	490NTC00005U	—
			40 m (131.234 ft)	490NTC00040U	—
			80 m (262.467 ft)	490NTC00080U	—



TCSESU043F1N0

**Shielded twisted pair cable for IP 67 switch**

Description	Pre-formed at both ends	Item	Length	Reference	Weight kg lb
<b>Straight cables</b>	1 x IP 67 4-way M12 connector and 1 x RJ45 connector	—	1 m (3.281 ft)	TCSECL1M3M1S2	—
			3 m (9.843 ft)	TCSECL1M3M3S2	—
			5 m (16.404 ft)	TCSECL1M3M5S2	—
			10 m (32.808 ft)	TCSECL1M3M10S2	—
			25 m (82.021 ft)	TCSECL1M3M25S2	—
			40 m (131.234 ft)	TCSECL1M3M40S2	—



TCSESM043F2C●0

Description	Number of ports		Item	Reference	Weight kg lb
	Copper cable	Fibre optic			
<b>Twisted pair hub</b> 10BASE-T copper ports, RJ45 shielded connectors	4	—	3	499NEH10410	0.530 1.168

**ConneXium switches**

Description	Number of ports		Item	Manag- eable	Reference	Weight kg lb
	Copper cable	Fibre optic				
<b>Optimized twisted pair switch</b> 10BASE-T/100BASE-TX copper ports, RJ45 shielded connectors 100BASE-FX optic port, SC connectors	3	—	3	No	TCS ESU033FN0	0.113 0.249
	4	1	3	No	TCS ESU043FN0	0.120 0.265
	5	—	3	No	TCS ESU053FN0	0.113 0.249
	8	—	3	No	499NES18100	0.230 0.507
<b>Twisted pair switches</b> 10BASE-T/100BASE-TX copper ports, RJ45 shielded connectors	8	—	4	Yes	TCSESM083F23F0	0.410 0.904
	3	1, multimode	4	Yes	TCSESM043F1CU0	0.400 0.882
<b>Twisted pair and fibre optic switches</b> 10BASE-T/100BASE-TX copper ports, RJ45 shielded connectors. 100BASE-FX optic ports, SC connectors	2	2, multimode	4	Yes	TCSESM043F2CU0	0.400 0.882
	3	1, single-mode	4	Yes	TCSESM043F1CS0	0.400 0.882
	2	2, single-mode	4	Yes	TCSESM043F2CS0	0.400 0.882
	4	1, multimode	3	No	499NMS25101	0.330 0.728
	3	2, multimode	3	No	499NMS25102	0.335 0.739
	4	1, single-mode	3	No	499NSS25101	0.330 0.728
	3	2, single-mode	3	No	499NSS25102	0.335 0.739
	7	1, multimode	4	Yes	TCSESM083F1CU0	0.410 0.904
	6	2, multimode	4	Yes	TCSESM083F2CU0	0.410 0.904
	7	1, single-mode	4	Yes	TCSESM083F1CS0	0.410 0.904



499NMS/NSS25102



TCSESM083F2C●0



TCSESU051F0

<b>IP 67 twisted pair switch (1)</b> 10BASE-T/100BASE-TX copper ports, shielded M12 connectors (type D)	5	—	—	No	TCSESU051F0	0.210 0.463
---	---	---	---	----	-------------	----------------

(1) Require special cables with M12 connectors for their --- 24 V supply: XZCP1●64L●

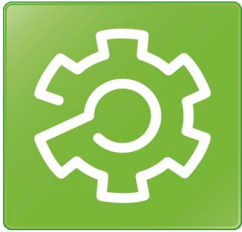

SoMachine software platform

### Presentation

SoMachine is the OEM solution software for developing, configuring and commissioning the entire machine in a single software environment, including logic, motion control, HMI and related network automation functions.

SoMachine allows you to program and commission all the elements in Schneider Electric's Flexible and Scalable Control platform, the comprehensive solution-oriented offer for OEMs, which helps you achieve optimized control solution for each machine's requirements.

Flexible and Scalable Control platforms include:

#### Controllers:

- HMI controllers: XBT GC, XBT GT/GK CANopen,
- Logic controllers: Modicon M238, Modicon M258,
- Motion Controller: Modicon LMC 058,
- Integrated Controller Card: Altivar IMC,
- I/Os range: Modicon TM2, Modicon TM5 and Modicon TM7 offers

#### HMI:

- Small Panels Magelis™ STO/STU
- Advanced Panels Magelis™ GH/GK/GT
- Optimum Advanced Panels Magelis™ GTO

SoMachine is a professional, efficient, and open software solution integrating Vijeo-Designer. It integrates also the configuring and commissioning tool for motion control devices. It features the IEC 61131-3 languages, integrated field bus configurators, expert diagnostics and debugging, as well as outstanding capabilities for maintenance and visualisation.

SoMachine integrates tested, validated, documented and supported expert application libraries dedicated to applications in Pumping, Packaging, Hoisting and Conveying.

SoMachine provides you:

- One software package
- One project file
- One cable connection
- One download operation

### Visual graphic user interface

Navigation within SoMachine is intuitive and highly visual. Presentation is optimized in such a way that selecting the development stage of the desired project makes the appropriate tools available. The user interface ensures nothing is overlooked, and suggests the tasks to be performed throughout the project development cycle. The workspace has been streamlined, so that only that which is necessary and relevant to the current task is featured, without any superfluous information.

### Learning centre

From the home menu, the learning centre provides several tools to get started with SoMachine. An animated file explains briefly the SoMachine interface and concept. An e-learning allows to run a self-training about SoMachine. A third section gives access to several documented examples of simple coding with SoMachine. An intuitive and efficient online help is also available, guiding you to get the appropriate answer.

### Projects management

The implemented project management principle allows to browse quickly through the existing projects getting the relevant information without the need to open them before selection.

The user can create a new project, starting from several means: using Tested Validated and Documented Architectures, using the provided examples, using an existing project or start with an empty project. There is quick access to the most recently-used projects.

There is as well a way to start a project from standard project taking advantages of a pre-configured program (task, library, ....)

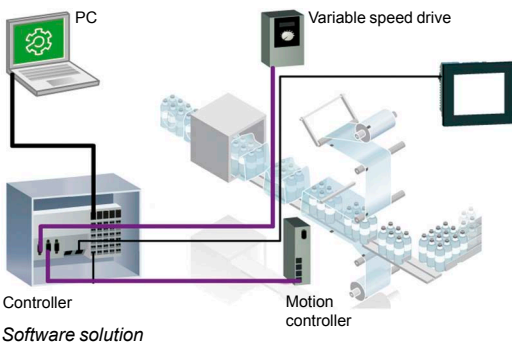

Software solution

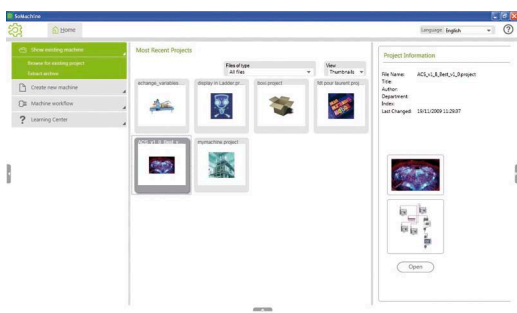

Project management

#### Project properties

For each project, the user has the option to define additional information, through simple forms. It's also possible to attach documents, a customer picture and a configuration picture.

#### Configuration

From the graphic user interface, the user can easily build his architecture and configure the devices of the architecture.

#### Description of the architecture

A graphic editor can be used to assemble the various elements easily by a simple drag & drop. A devices catalogue is displayed on the left of the screen. It is split into several sections: controllers, HMI, Miscellaneous and search.

#### Configuration of the device

Directly from the topologic view of the user interface, a simple click drives the user to the configuration screen of the selected device.

#### Programming and debug

Programming is an essential step, and the user has to carefully design it to be as efficient as possible. Advanced control and HMI functions cover all the needs of an OEM engineer in terms of creating the control and visualisation system. Powerful tools allow debug and functional tests such as simulation, step by step execution, break points and trace.

#### Commissioning

For an easy and fast diagnostic, the menu commissioning allows the user to check the online state of his architecture. Through the topologic view of the configuration, the devices display if you are logged in or not, as well as if they are in run or stop mode.

#### Documentation

Because a printed file of the project is an important element, it is possible to build and customize the project report:

- select the items to be included in the report,
- organize the sections,
- define the page layout
- and then launch the printing.

#### Transparency

SoMachine supports Device Type manager (DTM) because it is a field device tool (FDT) container.

With DTM's representing field device in SoMachine, direct communications are possible to every single device via SoMachine, the controller and the field bus (Modbus for all devices and CANopen for the I/O's).

From the SoMachine unique environment, the remote devices can be set-up off-line and tuned on-line.

#### Dedicated OEM application libraries (AFB libraries)

SoMachine can be extended through its solution extension DVD. It integrates tested, validated, documented and supported expert application libraries dedicated to many OEM applications. Their simple configuration speeds up design, commissioning, installation and troubleshooting.

These libraries cover the following applications:

- Packaging,
- Hoisting,
- Conveying,
- Pumping

#### Tested Validated Documented Architectures (TVDA)

SoMachine provides a variety of preset projects with ready-to-use architectures you can adapt to individual requirements. Some of them are generic TVDA, they are based on controllers configuration. The solution extension DVD brings specific application solutions oriented TVDA's to SoMachine.

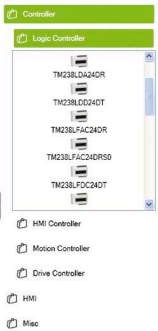

Configuration



Commissioning

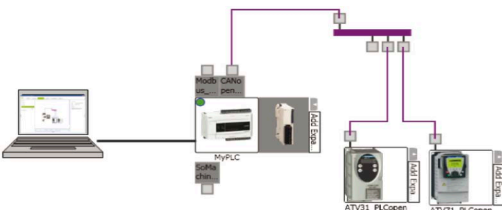

Transparency

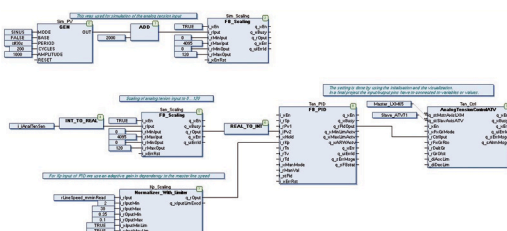

Application Function Blocks

SoMachine characteristics	
Overview	
IEC 61131-3 programming languages	<ul style="list-style-type: none"> <li>■ IL (Instruction List)</li> <li>■ LD (Ladder Diagram)</li> <li>■ SFC (Sequential Function Chart)</li> <li>■ ST (Structured Text)</li> <li>■ FBD (Function Block Diagram)</li> <li>■ + CFC (Continuous Function Chart)</li> </ul>
Controller programming services	<ul style="list-style-type: none"> <li>■ Multi-tasking: Mast, Fast, Event</li> <li>■ Functions (Func) and Function Blocks (FBs)</li> <li>■ Data Unit Type (DUTs)</li> <li>■ On-line changes</li> <li>■ Watch windows</li> <li>■ Graphical monitoring of variables (trace)</li> <li>■ Breakpoints, step-by-step execution</li> <li>■ Simulation</li> <li>■ Visualization for application and machine set-up</li> </ul>
HMI-based services	<ul style="list-style-type: none"> <li>■ Graphics libraries containing more than 4000 2D and 3D objects.</li> <li>■ Simple drawing objects (points, line, rectangles, ellipses, etc ...)</li> <li>■ Preconfigured objects (button, switch, bar graph, etc ...)</li> <li>■ Recipes (32 groups of 256 recipes with max. 1024 ingredients)</li> <li>■ Action tables</li> <li>■ Alarms</li> <li>■ Printing</li> <li>■ Java scripts</li> <li>■ Multimedia file support: wav, png, jpg, emf, bmp</li> <li>■ Variable trending</li> </ul>
Motion services	<ul style="list-style-type: none"> <li>■ Embedded devices configuration and commissioning</li> <li>■ CAM profile editor</li> <li>■ Sample application trace</li> <li>■ Motion and drive function blocks libraries for inverters, servos and steppers</li> <li>■ Visualization screens</li> <li>■ Logical encoder</li> </ul>
Global services	<ul style="list-style-type: none"> <li>■ User access and profile</li> <li>■ Project documentation printing</li> <li>■ Project comparison (control)</li> <li>■ Variable sharing based on publish/subscribe mechanism</li> <li>■ Library version management</li> <li>■ Energy efficiency machine monitoring</li> </ul>
Integrated fieldbus configurators	<ul style="list-style-type: none"> <li>■ Control network:                             <ul style="list-style-type: none"> <li>□ Modbus Serial Line</li> <li>□ Modbus TCP</li> </ul> </li> <li>■ Field bus:                             <ul style="list-style-type: none"> <li>□ CANopen</li> <li>□ CANmotion</li> </ul> </li> <li>■ Connectivity:                             <ul style="list-style-type: none"> <li>□ Profibus-DP</li> <li>□ Ethernet IP</li> </ul> </li> </ul>
Expert and solutions libraries	<ul style="list-style-type: none"> <li>■ PLCOpen function blocks for Motion control                             <ul style="list-style-type: none"> <li>□ Example: MC_MoveAbsolute, MC_CamIn, ServoDrive, ...</li> </ul> </li> <li>■ Packaging function blocks                             <ul style="list-style-type: none"> <li>□ Example: Analog film tension control, rotary knife, lateral film position control, ...</li> </ul> </li> <li>■ Conveying function blocks                             <ul style="list-style-type: none"> <li>□ Example: tracking, turntable, conveyor, ...</li> </ul> </li> <li>■ Hoisting functions                             <ul style="list-style-type: none"> <li>□ Hoisting function blocks: anti-sway, anti-crab, hoisting position synchronisation, ...</li> <li>□ Application template for industrial crane</li> </ul> </li> <li>■ Pumping application                             <ul style="list-style-type: none"> <li>□ Pumping function blocks</li> <li>□ Application template for booster</li> </ul> </li> <li>■ Energy Efficiency library</li> </ul>

### Product offer

SoMachine software is delivered on a DVD, it is a product oriented version that includes all SoMachine features related to generic hardware (M238, M258, LMC058, XBT GC, Altivar IMC), as well as generic TVDA

The solution features are added to SoMachine by installing its solution extension DVD. It includes all SoMachine solutions hardware, plus all the dedicated application libraries and TVDA.

### References

- SoMachine is available in 6 languages:
  - English
  - French
  - German
  - Italian
  - Spanish
  - Simplified Chinese.
- System Requirements:
  - Processor: Pentium 4 - 1,8 GHz or higher , Pentium M 1.0 GHz or equivalent
  - RAM Memory: 2 GByte; recommended: 3 GByte
  - Hard Disk: 3.5 GB, recommended: 5 GB
  - OS: Windows XP Professional, Windows 7 Professional 32/64 bytes
  - Drive: DVD reader
  - Display: 1024 × 768 pixel resolution or higher
  - Peripherals: a Mouse or compatible pointing device
  - Peripherals: USB interface
  - Web Access: Web registration requires Internet access
- The documentation is supplied in electronic format: complete on-line help plus complementary documentation in pdf version.

### SoMachine software for generic controllers

Supported controllers	TVDA	Reference	
		DVD (1)	Licence (2)/ number & type
■ M238	- Optimized HW XBT GC	MSDCHNSFNV31 + Trial licence (30 days)	MSDCHNLMUA /1 (Single) MSDCHNLMTA /10 (Team) MSDCHNLMFA /100 (Facility)
■ M258	- Optimized HW M238		
■ LMC058	- Optimized CANopen M238		
■ XBT GC	- Optimized AS-Interface M238		
■ XBT GT/GK with control function	- Optimized CANopen XBT GC/GT/GK		
■ Altivar IMC	- Optimized CANopen Altivar IMC		
	- Performance HW M258		
	- Performance CANopen M258 - Performance CANmotion LMC058		

### SoMachine solution extension for Solution controllers (3)

Added controllers	Added TVDA	Added libraries	Reference (4)
			DVDs and Licence / number & type
■ M238S	- Optimized CANopen Altivar	Hoisting Conveying Packaging	MSDCHLLMUV31S0 / 1 (Single) MSDCHLLMTV31S0 / 10 (Team) MSDCHLLMFV31S0 /100 (Facility)
■ M258S	IMC		
■ LMC058S	- Performance CANmotion		
■ XBT GC with CANopen module type S	LMC058		
■ XBT GT/GK with control function type S	- Hoisting Optimized CANopen M238		
■ Altivar IMC with control function type S	- Conveying Performance CANmotion LMC058		

### SoMachine software compatibility and hardware control platforms

Product type	Version
Logic controller Modicon M238	≥ V1.0
HMI controller XBT GC	
Logic controller Modicon M238S	≥ V2.0
Modicon M258 logic controller	
Modicon M258 logic controllerS	
Modicon LMC058 Motion controller	≥ V3.0
Modicon LMC058 Motion controllerS	≥ V2.0
HMI controller XBT GT/GK with control function type S, XBT GC with CANopen module type S	
Altivar IMC integrated controller card	≥ V3.1
Altivar IMC integrated controller card with control function type S	≥ V2.0
TM5 CANopen Interface	≥ V3.0
TM7 CANopen Interface block	
Altivar IMC integrated controller card (with patch)	

(1) The DVD is mandatory and delivered with a trial licence.

(2) One of the 3 type of Licences is mandatory.

(3) For this offer, please contact Schneider electric.

(4) Each reference for SoMachine solution software contains: one generic trail DVD, one solution extension V3.1 DVD and one licence.

# Modicon LMC058 Motion controller

Associated offers  
Altivar 32 variable speed drives and Lexium 32 motion control

Application areas	Commons
	Specific
Technology type	

Printing, material handling, conveying, transfer machines, packaging, textiles, etc.
Hoisting, wood-working or metal processing machines, etc.
Altivar 32 variable speed drives without sensor (velocity control)



<b>Power range for 50...60 Hz (kW) line supply</b>	
	Single-phase 100...120 V (kW)
	Single-phase 200...240 V (kW)
	Three-phase 380...480 V (kW)
	Three-phase 380...500 V (kW)

0.18...15
–
0.18...2.2
–
0.37...15

<b>Drive</b>	Motor speed	
	Type of control	Asynchronous motor
		Synchronous motor
	Motor sensor	Integrated Available as an option
	Transient overtorque	
	Peak current	

0.1...599 Hz
Voltage/frequency ratios: U/f and 5-point U/f
Sensorless flux vector control ratio
Kn <sup>2</sup> quadratic ratio (pump/fan)
Energy saving ratio
Ratio for synchronous motor without sensor
–
–
170...200% of the nominal motor torque
–

<b>Number of functions</b>	
<b>Safety functions</b>	Integrated Available as an option

150
4: STO (Safe Torque Off), SLS (Safe Limited Speed), SDI (Safe Direction Information), SS1 (Safe Stop 1)
–

<b>Number of I/O</b>	Inputs	Analog
		Logic
	Outputs	Analog
		Logic
	Relay outputs	

3
6
1: configurable as voltage (0-10 V) or current (0-20 mA)
1
2

<b>Communication</b>	Integrated Available as an option Bluetooth link®
----------------------	---

Modbus, CANopen
DeviceNet, PROFIBUS DP V1, EtherNet/IP, Modbus TCP, EtherCat
Integrated

<b>Options</b>	
----------------	--

SoMove setup software
Simple Loader and Multi-Loader configuration tools
IP 54 or IP 65 remote display terminal and remote graphic display terminal
Filters, braking resistors, line chokes

<b>Standards and certifications</b>	
-------------------------------------	--

IEC 61800-5-1, IEC 61800-3 (environments 1 and 2, category C2), UL 508C, EN 954-1 category 3, ISO/EN 13849-1/- 2 category 3 (PL e), IEC 61508 (parts 1 & 2) SIL 3 level, draft standard EN 50495E IEC 60721-3-3, classes 3C3 and 3S2
CE, UL, CSA, C-Tick, NOM, GOST

<b>References</b>	
-------------------	--

<b>ATV 32</b>
---------------

<b>Pages</b>	
--------------	--

Please consult our web site <a href="http://www.schneider-electric.com">www.schneider-electric.com</a>
--



More technical information on [www.schneider-electric.com](http://www.schneider-electric.com)



Printing, material handling, conveying, transfer machines, packaging, textiles, etc.  
 Clamping, cutting, cutting to length, flying shear, rotary knife, Pick & Place, winding, marking, etc.

**Lexium 32 servo drives with sensor feedback (position control)**

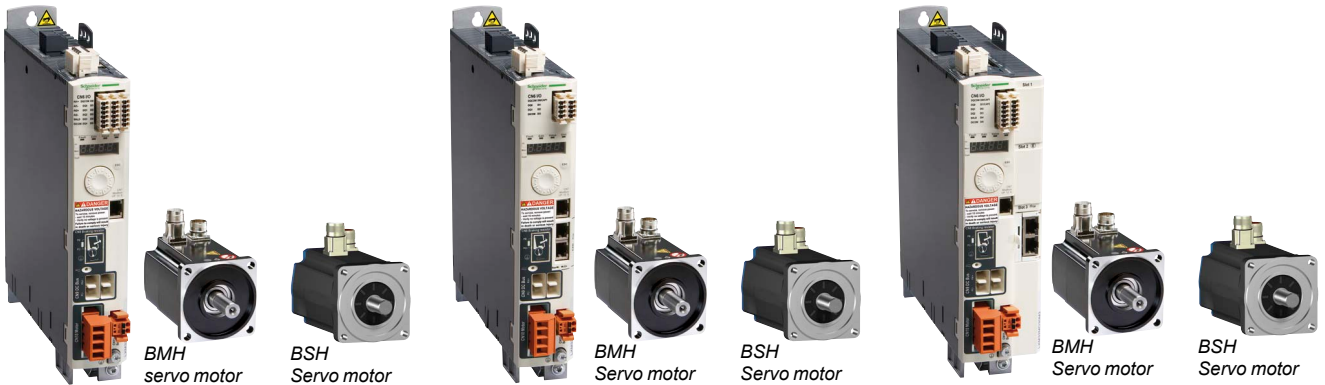

0.15...7  
 0.15...0.8  
 0.3...1.6  
 0.4...7  
 -

**Nominal speed:**

- BMH servo motors: continuous stall torque range between 1.2...84 Nm for nominal speeds between 1200 and 5000 rpm
- BSH servo motors: continuous stall torque range between 0.5...33.4 Nm for nominal speeds between 2500 and 6000 rpm

Synchronous motor with sensor feedback for BMH and BSH servo motors

SinCos Hiperface® sensor

Resolver encoder  
 Analog encoder (motor and machine)  
 Digital encoder (machine only)

Peak current, up to 4 times the drive direct current for 1 second

1: STO (Safe Torque Off)

4: SLS (Safe Limited Speed), SS1 (Safe Stop 1), SS2 (Safe Stop 2), SOS (Safe Operating Stop)

2	-	-
6	1 capture input	6 (2 of which can be used as a capture input)
-	-	-
5	-	3
-	-	-
Modbus	Modbus, CANopen, CANmotion	Modbus
-	-	CANopen, CANmotion, DeviceNet, EtherNet/IP, PROFIBUS DP V1, EtherCat
Available as an option	Available as an option	Available as an option

SoMove setup software  
 Multi-Loader configuration tool  
 Graphic display terminal  
 Filters, braking resistors, line chokes

IEC 61800-5-1, IEC 61800-3 (environments 1 and 2, categories C2 and C3), IEC 61000-4-2/4-3/4-4/4-5, ISO/EN 13849-1 (PL e), IEC 61508 SIL 3 level

CE, UL, CSA, TÜV

**LXM 32C**                      **LXM 32A**                      **LXM 32M**

Please consult our web site [www.schneider-electric.com](http://www.schneider-electric.com)



More technical information on [www.schneider-electric.com](http://www.schneider-electric.com)

Applications	Pre-assembled starters			
	Small machines starting under full load: D.O.L. starters		Machines starting under no-load: star-delta starters	
Starter type	D.O.L. or reversing starters with circuit-breaker		D.O.L. starters with fuse protection	Soft start units or star-delta starters to be used in association with a circuit-breaker or fuses
				
Level of service	Type 1 coordination		Type 2 coordination	–
Power at 400 V	Up to 5.5 kW	Up to 37 kW	Up to 37 kW	Up to 132 kW
Type of components	Combination automatic motor starter with overload protection built into the circuit-breaker		Fuse carrier + plate-mounted contactor	3 contactors (line, star and delta, mounted on plate, rail or chassis)
Pages	Please consult your Customer Care Centre			



**Starters for customer assembly**

**Small machines starting under full load: D.O.L. starters**  
**Machines starting under no-load: star-delta starters**

**D.O.L. or reversing starters**

**D.O.L., reversing or star-delta starters with circuit-breakers**

**D.O.L., reversing or star-delta starters with fuses**



Total coordination

Type 1 and type 2 coordination

–

–

Up to 15 kW

Up to 110 kW

Up to 315 kW

Up to 355 kW

**Starter-controller**

**Thermal magnetic circuit-breaker + contactor(s)**

**Magnetic circuit-breaker + contactor(s) + thermal overload relay**

**Fuse carrier + contactor(s) + thermal overload relay**

**Switch-disconnector-fuse + contactor(s) + thermal overload relay**

Please consult your Customer Care Centre

## Associated offers

Power supplies and transformers Phaseo

Regulated switch mode power supplies

**Power supplies**

**Regulated switch mode power supplies**

**ABL 8MEM, ABL 7RM: 7 to 60 W - Rail mounting**  
**ABL 8REM, ABL 7RP: 60 to 144 W - Rail mounting**



**Nominal input voltage**

~ 100...240 V  
 ⎓ 120...250 V

**Connection to worldwide line supplies**

United States  
 - 120 V (phase-to-neutral)  
 - 240 V (phase-to-phase)

Single-phase (N-L1) connection  
 or  
 2-phase (L1-L2) connection

Europe  
 - 230 V (phase-to-neutral)  
 - 400 V (phase-to-phase)

Single-phase (N-L1) connection

United States  
 - 277 V (phase-to-neutral)  
 - 480 V (phase-to-phase)

–

**Undervoltage control**

Yes

**Protection against overloads and short-circuits**

Yes, voltage detection.  
 Automatic reset on elimination of the fault

**Diagnostics relay**

–

**Compatibility with function modules**

–

**Power reserve (Boost)**

1.25 to 1.4 In for 1 minute, depending on model (for ABL 8MEM)      No

**Output voltage**

⎓ 5 V      ⎓ 12 V      ⎓ 24 V      ⎓ 48 V

**Output current**

0.3 A

---

0.6 A

---

1.2 A

---

2 A

---

2.5 A

---

3 A

---

3.5 A

---

4 A

---

5 A

---

6 A

---

10 A

---

20 A

---

30 A

---

40 A

⎓ 5 V	⎓ 12 V	⎓ 24 V	⎓ 48 V
		<b>ABL 8MEM24003</b>	
		<b>ABL 8MEM24006</b>	
		<b>ABL 8MEM24012</b>	
	<b>ABL 8MEM12020</b>		
		<b>ABL 7RM24025</b>	<b>ABL 7RP4803</b>
		<b>ABL 8REM24030</b>	
<b>ABL 8MEM05040</b>			
	<b>ABL 7RP1205</b>	<b>ABL 8REM24050</b>	

**Pages**

Please consult our web site [www.schneider-electric.com](http://www.schneider-electric.com)

**ABL4: 85 to 960 W - Compact - Rail mounting**

**Function modules ABL 8DCC: converters ---/---**



~ 100...230 V	~ 120 V or ~ 230 V	~ 400...500 V	--- 24 V
Single-phase (N-L1) connection	Single-phase (N-L1) connection or 2-phase (L1-L2) connection	–	–
–	Single-phase (N-L1) connection	3-phase (L1-L2-L3) connection	–
–	–	3-phase (L1-L2-L3) connection	–
No	No	No	–
Yes, current limitation			Yes, current limitation
Automatic reset on elimination of the fault			
Yes	Yes	Yes	Yes, depending on model
Yes with buffer module, battery and battery check modules, redundancy module and discriminating downstream protection module			
Depending on model: 1.5 to 1.7 In for 5 to 30 seconds			No

--- 24 V	--- 5 V	--- 7...12 V
		<b>ABL 8DCC12020 (1)</b>
<b>ABL 4RSM24035</b>		
<b>ABL 4RSM24050</b>		
	<b>ABL 8DCC05060 (1)</b>	
	<b>ABL 4RSM24100</b>	
	<b>ABL 4RSM24200</b>	<b>ABL 4WSR24200</b>
		<b>ABL 4WSR24300</b>
		<b>ABL 4WSR24400</b>

Please consult our web site [www.schneider-electric.com](http://www.schneider-electric.com) (2)

(1) Converter module ---/---, must be used with a Phaseo power supply.

(2) Certain offers can not be marketed in certain countries, please consult your "Customer Care Centre".

<b>Applications</b>		<b>Display of graphic pages</b>		
<b>Type of terminal</b>		<b>Small Panels with touch screen</b>		
				
<b>Display</b>	Type	Monochrome STN LCD (200 x 80 pixels), backlit - Green, orange and red, or - White, pink and red		Colour QVGA TFT LCD (320 x 240 pixels)
	Capacity	3.4" (monochrome)	3.5" (colour)	5.7" (colour)
<b>Data entry</b>		Via touch screen		
<b>Memory capacity</b>	Application	16 MB Flash		
	Expansion	-		
<b>Functions</b>	Maximum number of pages	Limited by internal FLASH EPROM memory capacity		
	Variables per page	Unlimited		
	Representation of variables	Alphanumeric, bitmap, bargraph, gauge, curves, buttons, LEDs		
	Recipes	32 groups of 64 recipes		
	Curves	Yes, with log		
	Alarm logs	Yes		
	Real-time clock	Access to the PLC real-time clock		
	Alarm relay	-		
Buzzer	Yes			
<b>Communication</b>	Asynchronous serial link	RS 232C/RS 485 (1) RS 232C using Zelio protocol (2)	RS 232C/RS 485	
	Downloadable protocols	Uni-TE, Modbus and for PLC brands: Allen-Bradley, Omron, Mitsubishi, Siemens		
	Printer link	USB for serial or parallel printer		
	USB ports	1 host type A and 1 device type mini-B		
	Networks	1 Ethernet TCP/IP port (10BASE-T/100BASE-TX) (3)	1 Ethernet TCP/IP port (10BASE-T/100BASE-TX)	
<b>Development software</b>		Vijeo Designer (on Windows XP, Windows Vista and Windows 7)		
<b>Operating system</b>		Magelis		
<b>References</b>		<b>HMI STO 5●●</b>	<b>HMI STU 655</b>	<b>HMI STU 855</b>
<b>Page</b>		Please consult our web site <a href="http://www.schneider-electric.com">www.schneider-electric.com</a> (1) Only HMI STO 511/512. (2) Only HMI STO 501. (3) Only HMI STO 531/532.		



Display of text messages and/or semi-graphic pages	Display of text messages and/or semi-graphic pages Control and configuration of data	
--	---	--

Small Panels with keypad	Small Panels with keypad	Small Panels with touch screen and keypad
--------------------------	--------------------------	---

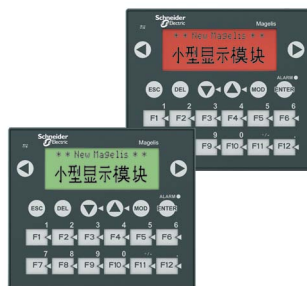

Green backlit monochrome LCD, height 5.5 mm or Green, orange or red backlit monochrome LCD, height 4.34...17.36 mm	Green, orange or red backlit monochrome LCD, height 4.34...17.36 mm	Green, orange or red backlit monochrome matrix LCD (198 x 80 pixels), height 4...16 mm
2 lines of 20 characters or 1 to 4 lines of 5 to 20 characters (monochrome)	1 to 4 lines of 5 to 20 characters (monochrome)	2 to 10 lines of 5 to 33 characters (monochrome)
Via keypad with 8 keys (4 customizable)	Via keypad with ■ 12 function keys or numeric entry (depending on context) ■ 8 service keys	Via keypad with ■ 4 function keys ■ 8 service keys Via touch screen and keypad with ■ 10 function keys ■ 2 service keys
512 KB Flash		512 KB Flash EPROM
128/200 application pages 256 alarm pages 40...50	128/200 application pages 256 alarm pages 40...50, bargraph, buttons, LEDs	200 application pages 256 alarm pages 50
Alphanumeric		Alphanumeric, bargraph, buttons, LEDs
Yes	Yes	Yes (4)
Access to the PLC real-time clock	Access to the PLC real-time clock	

RS 232C/RS 485		
Uni-TE, Modbus and for PLC brands: Allen-Bradley, Omron, Mitsubishi, Siemens		
RS 232C serial link (5)		
Vijeo Designer Lite (on Windows 2000, Windows XP and Windows Vista)		
Magelis		

XBT N ●●●●	XBT R ●●●	XBT RT ●●●
------------	-----------	------------

Please consult our web site [www.schneider-electric.com](http://www.schneider-electric.com)  
 (4) Only XBT RT511.  
 (5) Depending on model.

## Associated offers

Operator dialogue terminals: Magelis GT, GK, GH and GTW Advanced Panels

<b>Applications</b>		<b>Display of text messages, graphic objects and synoptic views Control and configuration of data</b>		
<b>Type of terminal</b>		<b>Touch screen Advanced Panels</b>		
				
<b>Display</b>	Type	Backlit monochrome (amber or red mode) STN LCD (320 x 240 pixels) or TFT LCD	Backlit monochrome or colour STN LCD or backlit colour TFT LCD (320 x 240 pixels) or (640 x 480 pixels) (3)	Backlit colour STN LCD or colour TFT LCD (640 x 480 pixels)
	Capacity	3.8" (monochrome or colour)	5.7" (monochrome or colour)	7.5" (colour)
<b>Data entry</b>	Static function keys	Via touch screen		
	Dynamic function keys	-		
	Service keys	-		
	Alphanumeric keys	-		
		-		
<b>Memory capacity</b>	Applications	32 MB Flash EPROM	16 MB Flash EPROM (3)	32 MB Flash EPROM
	Expansion	-	By means of 128, 256, 512 MB, 1, 2 or 4 GB CF card (except XBT GT2110)	
<b>Functions</b>	Maximum number of pages	Limited by internal Flash EPROM memory capacity	Limited by capacity of internal Flash EPROM memory or CF card memory	
	Variables per page	Unlimited (8000 variables max.)		
	Representation of variables	Alphanumeric, bitmap, bargraph, gauge, tank, tank level indicator, curves, polygon, button, LED		
	Recipes	32 groups of 64 recipes comprising 1024 ingredients max.		
	Curves	Yes, with log		
	Alarm logs	Yes		
	Real-time clock	Built-in		
	Discrete I/O	-	1 input (reset) and 3 outputs (alarm, buzzer, run)	
	Multimedia I/O	-	(3)	1 audio input (microphone), 1 composite video input (digital or analogue video camera), 1 audio output (loudspeaker) (1)
	<b>Communication</b>	Downloadable protocols	Uni-TE (2), Modbus, Modbus TCP/IP (1) and for PLC brands: Mitsubishi, Omron, Allen-Bradley and Siemens	
Asynchronous serial link		RS 232C/485 (COM1)	RS 232C/RS 422/485 (COM1) and RS 485 (COM2)	
USB ports		1	1 (3)	1
Bus and networks		-	Modbus Plus and Fipway with USB gateway, PROFIBUS DP and Device Net with optional card	
		Ethernet TCP/IP (10BASE-T/100BASE-TX) (1)		
Printer link		USB port for parallel printer	RS 232C (COM1) serial link, USB port for parallel printer	
<b>Development software</b>		Vijeo Designer (on Windows XP, Windows Vista and Windows 7)		
<b>Operating system</b>		Magelis (200 MHz RISC CPU)	Magelis (133 MHz RISC CPU) (3)	Magelis (266 MHz RIS CPU)
<b>Type of terminal</b>		<b>XBT GT11/13</b>	<b>XBT GT21/22/23/24/29</b>	<b>XBT GT42/43</b>
<b>Page</b>		Please consult our web site <a href="http://www.schneider-electric.com">www.schneider-electric.com</a>		

(1) Depending on model.  
 (2) Uni-TE version V2 for Twido controller and TSX Micro/Premium platform.  
 (3) For XBTGT 2430, 32 MB Flash EPROM, 1 sound output, 2 USB ports, 266 MHz RISC CPU.  
 (4) For XBT GT 5430.



**Display of text messages, graphic objects and synoptic views  
Control and configuration of data**

**Touch screen Advanced Panels**



Backlit colour STN LCD or colour TFT LCD  
(640 x 480 pixels or 800 x 600 pixels) (4)

Backlit colour TFT LCD (800 x 600 pixels)

Backlit colour TFT LCD (1024 x 768 pixels)

10.4" (colour)

12.1" (colour)

15" (colour)

Via touch screen

- 
- 
- 
- 

32 MB Flash EPROM

By means of 128, 256, 512 MB, 1, 2 or 4 GB CF card

Limited by capacity of internal Flash EPROM memory or CF card memory

Unlimited (8000 variables max.)

Alphanumeric, bitmap, bargraph, gauge, tank, tank level indicator, curves, polygon, button, LED

32 groups of 64 recipes comprising 1024 ingredients max.

Yes, with log

Yes

Built-in

1 input (reset) and 3 outputs (alarm, buzzer, run)

1 audio input (microphone), 1 composite video input (digital or analogue video camera), 1 audio output (loudspeaker) (1)

Uni-TE (2), Modbus, Modbus TCP/IP (1) and for PLC brands: Mitsubishi, Omron, Allen-Bradley and Siemens

RS 232C/RS 422/485 (COM1) and RS 485 (COM2)

2

Modbus Plus with USB gateway

Ethernet TCP/IP (10BASE-T/100BASE-TX)

RS 232C (COM1) serial link, USB port for parallel printer

Vijeo Designer (on Windows XP, Windows Vista and Windows 7)

Magelis

(266 MHz RIS CPU)

**XBT GT52/53/54**

**XBT GT63**

**XBT GT73**

Please consult our web site [www.schneider-electric.com](http://www.schneider-electric.com)



More technical information on [www.schneider-electric.com](http://www.schneider-electric.com)

# Modicon LMC058 Motion controller

## Associated offers

Operator dialogue terminals: Magelis GT, GK, GH and GTW Advanced Panels

<b>Applications</b>	Display of text messages, graphic objects and synoptic views Control and configuration of data	
<b>Type of terminal</b>	Advanced Panels with keypad	
		
<b>Display</b>	Type	Colour TFT LCD (320 x 240 pixels) or monochrome STN
	Capacity	5.7" (monochrome or colour)
		Colour TFT LCD (640 x 480 pixels) 10.4" (colour)
<b>Data entry</b>	Via keypad and/or touch screen (configurable) and/or by industrial pointer	
	Static function keys	10
	Dynamic function keys	14
	Service keys	8
	Alphanumeric keys	12
<b>Memory capacity</b>	Application	16 MB Flash EPROM
	Expansion	32 MB Flash EPROM By means of 128, 256, 512 MB, 1, 2 or 4 GB CF card
<b>Functions</b>	Maximum number of pages	Limited by capacity of internal Flash EPROM memory or CF card memory
	Variables per page	Unlimited (8000 variables max.)
	Representation of variables	Alphanumeric, bitmap, bargraph, gauge, tank, tank level indicator, curves, polygon, button, LED
	Recipes	32 groups of 64 recipes comprising 1024 ingredients max.
	Curves	Yes, with log
	Alarm logs	Yes
	Real-time clock	Built-in
	Discrete I/O	–
	Multimedia I/O	1 input - 3 outputs
		–
<b>Communication</b>	Downloadable protocols	Uni-TE (2), Modbus, Modbus TCP/IP (1) and for PLC brands: Mitsubishi, Omron, Allen-Bradley and Siemens
	Asynchronous serial link	RS 232C/RS 422/485 (COM1) RS 485 (COM2)
	USB ports	1
	Bus and networks	2 Modbus Plus, Fipway with USB gateway, PROFIBUS DP and Device Net with optional card Ethernet TCP/IP (10BASE-T/100BASE-TX)
	Printer link	RS 232C (COM1) serial link, USB port for parallel printer
<b>Development software</b>	Vijeo Designer (on Windows XP, Windows Vista and Windows 7)	
<b>Operating system</b>	Magelis (CPU 266 MHz RISC)	
<b>Type of terminal</b>	<b>XBT GK 21/23</b>	<b>XBT GK 53</b>
<b>Page</b>	Please consult our web site <a href="http://www.schneider-electric.com">www.schneider-electric.com</a>	

(1) Depending on model.

(2) Uni-TE version V2 for Twido controller and TSX Micro/Premium platform.





**Display of text messages, graphic objects and synoptic views  
Control and configuration of data**

**Portable Advanced Panels**

**Open touch screen Advanced Panels**

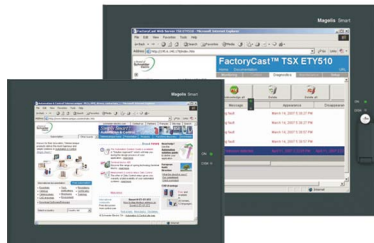

Colour TFT LCD (640 x 480 pixels)	Colour TFT LCD (800 x 600 pixels)	Colour TFT LCD (800 x 600 pixels)	Colour TFT LCD (1024 x 768 pixels)
5.7" (colour)	8.4" (colour)	12" (colour)	15" (colour)
Via touch screen	Via touch screen		
11	–		
–	–		
–	–		
–	–		
32 MB Flash EPROM	1 GB CF system card included with terminal, expandable to 4 GB	2 GB CF system card included with terminal, expandable to 4 GB	
By means of 128, 256, 512 MB, 1, 2 or 4 GB CF card			
Limited by capacity of internal Flash EPROM memory or CF card memory			
Unlimited (8000 variables max.)			
Alphanumeric, bitmap, bargraph, gauge, tank, tank level indicator, curves, polygon, button, LED			
32 groups of 64 recipes comprising 1024 ingredients max.			
Yes, with log			
Yes			
Built-in			
–			
1 audio output			
Uni-TE (2), Modbus, Modbus TCP/IP and for PLC brands: Mitsubishi, Omron, Rockwell Automation and Siemens	Uni-TE (2), Modbus, Modbus TCP/IP (1) and for PLC brands: Mitsubishi, Omron, Allen-Bradley and Siemens		
RS 232C/RS 422-485 (COM1)	RS 232C (COM1) RS 232C (COM2)	RS 232C (COM1)	RS 232C (COM1) RS 232C (COM2)
1	4	4 + 1 on front	
–	Modbus Plus with USB gateway		
1 Ethernet port (10BASE-T/100BASE-TX)	1 TCP/IP Ethernet port (10BASE-T/100BASE-TX) and 1 Ethernet port (10BASE-T/100BASE-TX/1 GB)		
–	RS 232C (COM1 or COM2) serial link, USB port for parallel printer		
Vijeo Designer (on Windows XP, Windows Vista and Windows 7)			
Magelis (266 MHz RISC CPU)	Windows XP Embedded		

**XBT GH 2460**

**XBT GTW 450**

**XBT GTW 652**

**HMI GTW 7353**

Please consult our web site [www.schneider-electric.com](http://www.schneider-electric.com)

(1) Depending on model.

(2) Uni-TE version V2 for Twido controller and TSX Micro/Premium platform.



More technical information on [www.schneider-electric.com](http://www.schneider-electric.com)

**Schneider Electric Industries SAS**

[www.schneider-electric.com](http://www.schneider-electric.com)

Head Office  
35, rue Joseph Monier  
F-92500 Rueil-Malmaison  
France

The information provided in this documentation contains general descriptions and/or technical characteristics of the performance of the products contained herein. This documentation is not intended as a substitute for and is not to be used for determining suitability or reliability of these products for specific user applications. It is the duty of any such user or integrator to perform the appropriate and complete risk analysis, evaluation and testing of the products with respect to the relevant specific application or use thereof. Neither Schneider Electric nor any of its affiliates or subsidiaries shall be responsible or liable for misuse of the information contained herein.

Design: Schneider Electric  
Photos: Schneider Electric  
Printed by:

DIA7ED2100803EN