

SET LAUFEN PRO A

Countertop basin

81895.2



TECHNICAL DATA

Order no.	81895.2
Certified to	EN 31
Dimensions	600 x 480 mm
Specification	Charge 104 – 1 centre tap hole
Special specification	Charge 109 – without tap hole
Weight	17,0 kg
Accessories excl.	Siphon cover, order no. 81995.1 Pedestal, order no. 81995.0
Mounting acc. excl.	Mounting set M10 x 140 mm, order no. 89988.2
Colours	see colour table

SPECIFICATION TEXT

Countertop basin LAUFEN PRO A, sanitary ceramic
EN 31

dimensions 600 x 480 mm, angular

1 centre tap hole

Special feature: overflow channel glazed

Further options / accessories: Surface refinement LCC (only white option 104), without tap holes (only white 000), siphon cover, pedestal, bathtubs, furniture

Order no. 81895.2

TECHNICAL DRAWINGS / S 1 : 20

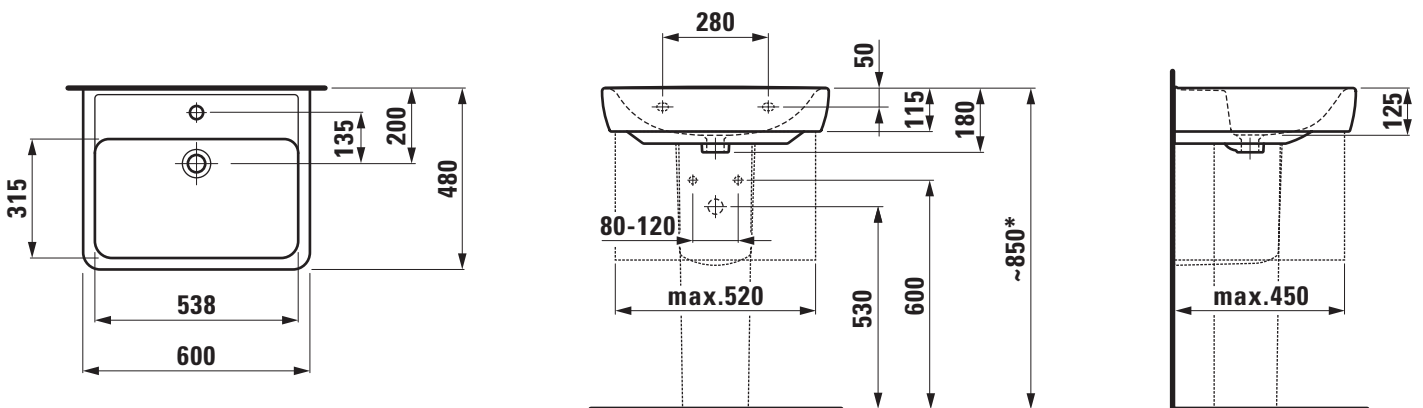

* = Effective height must be fixed according to the height of the pedestal.