

# INSTALLATION MANUAL

MONTAGEANLEITUNG  
INSTRUCTIONS DE MONTAGE  
ISTRUZIONI PER IL MONTAGGIO

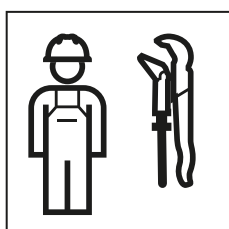



1

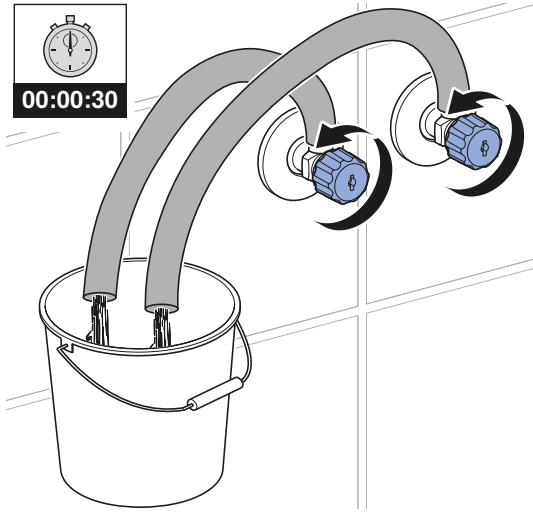

2

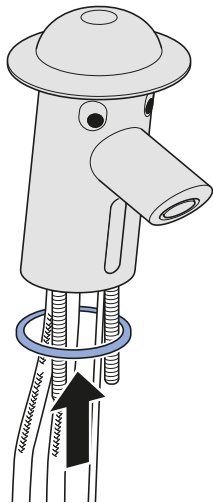

3

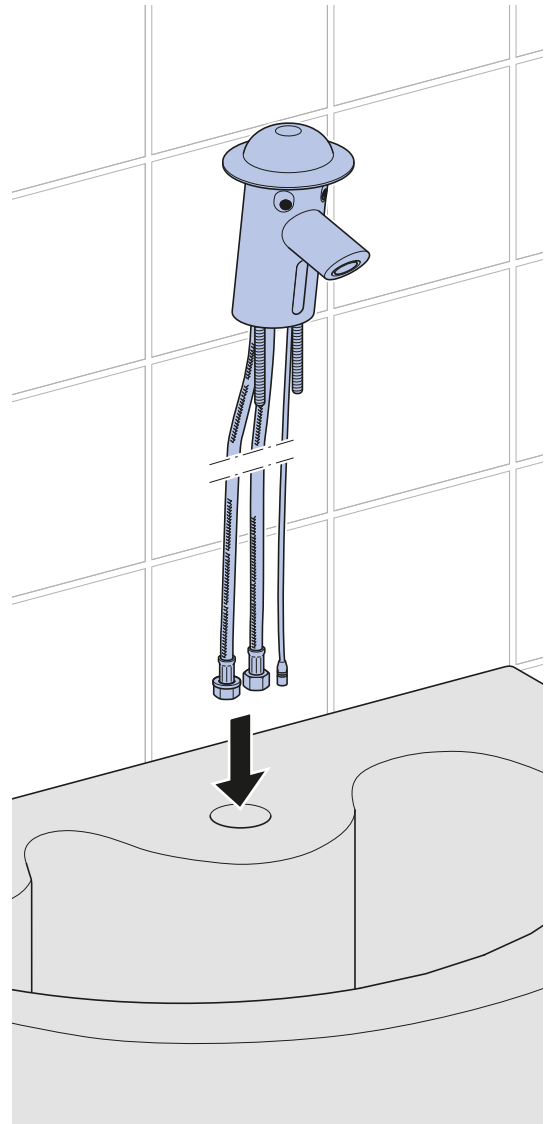

4

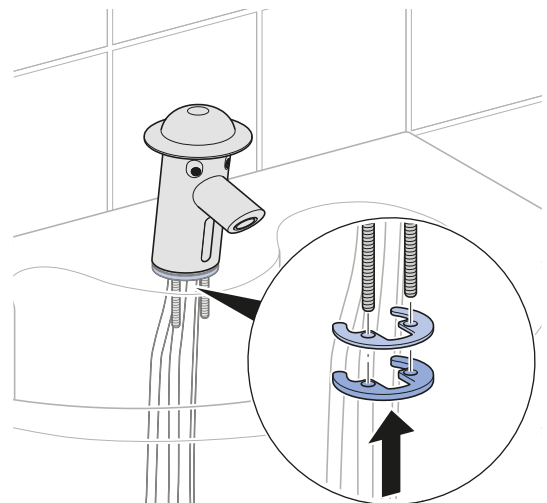

5

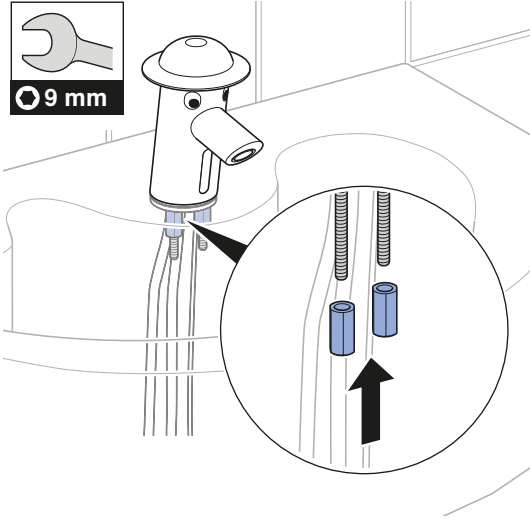

2

1

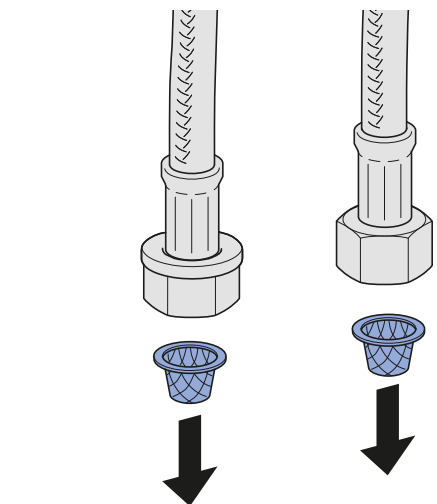
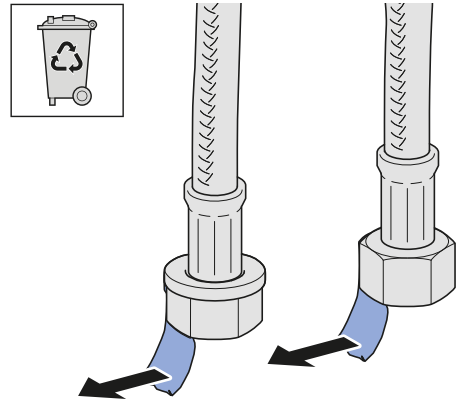

2

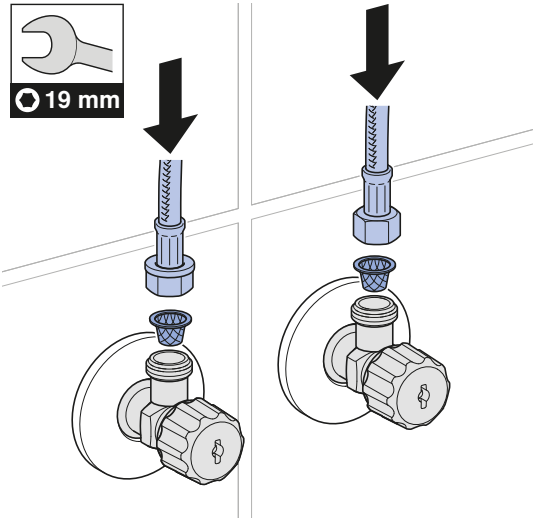

**3**

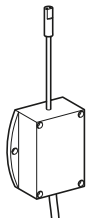

**3 A**  4

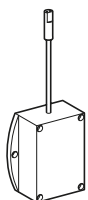
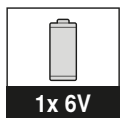

**3 B**  5

**3 A**

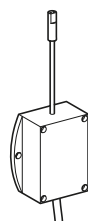

**1**

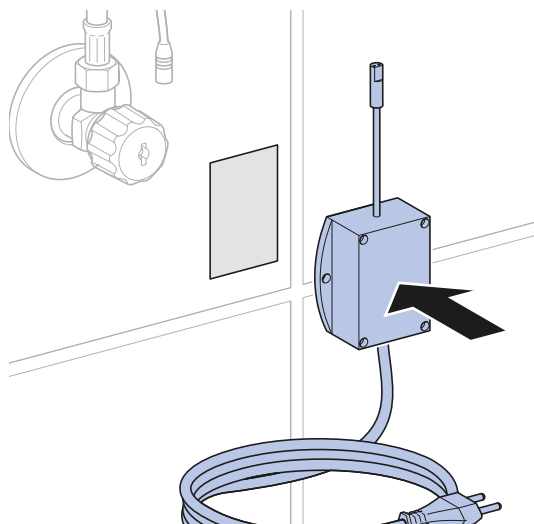
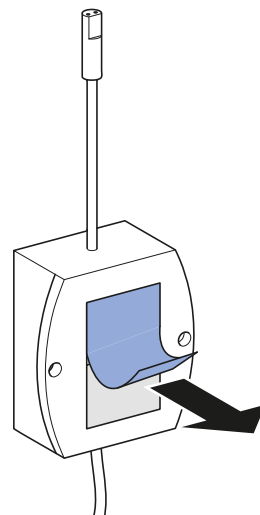

2

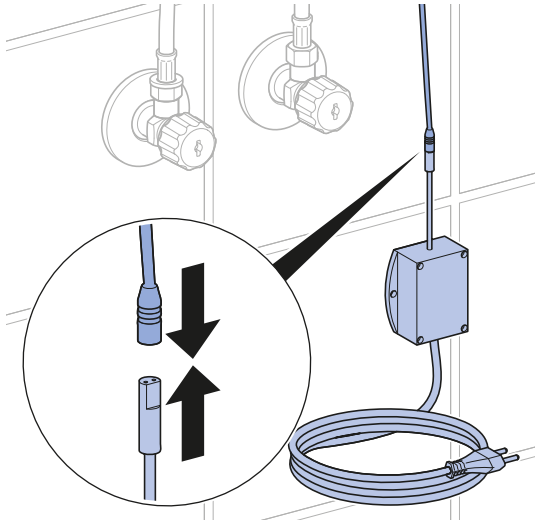

3

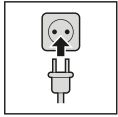

3 B

✓

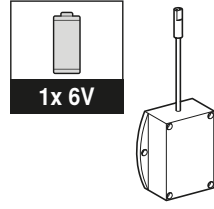

1

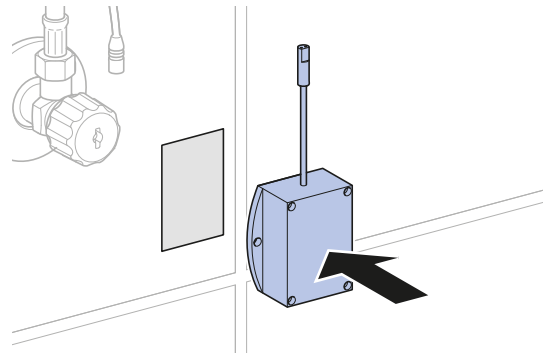
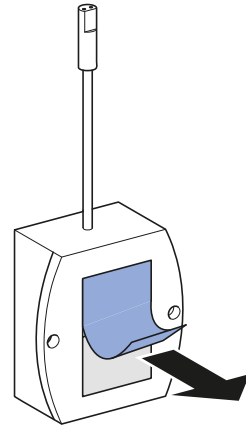

2

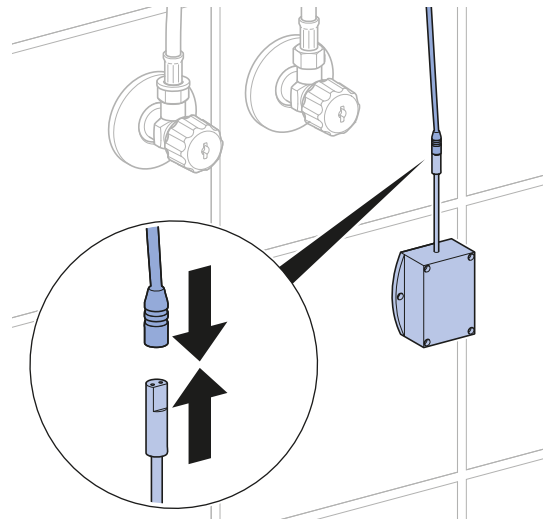



1

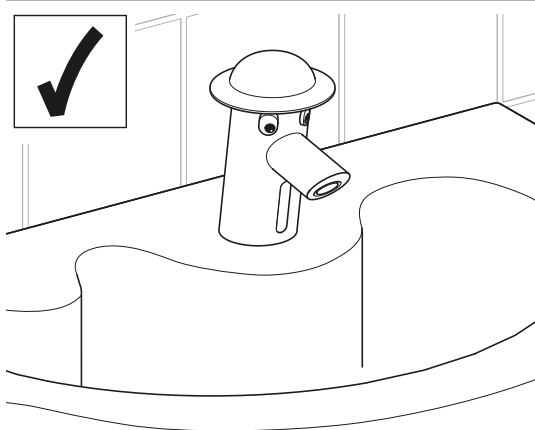

2

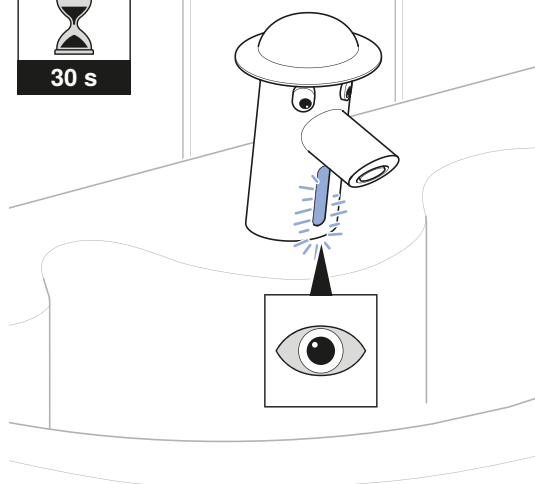
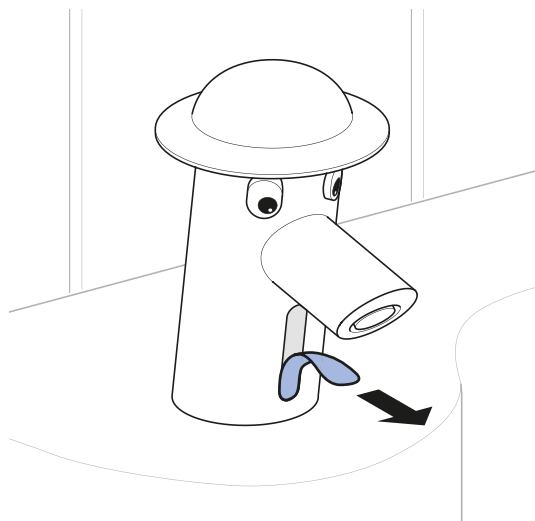

3

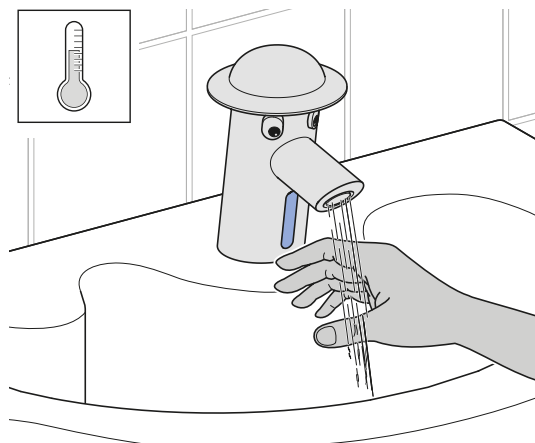
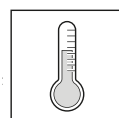

4

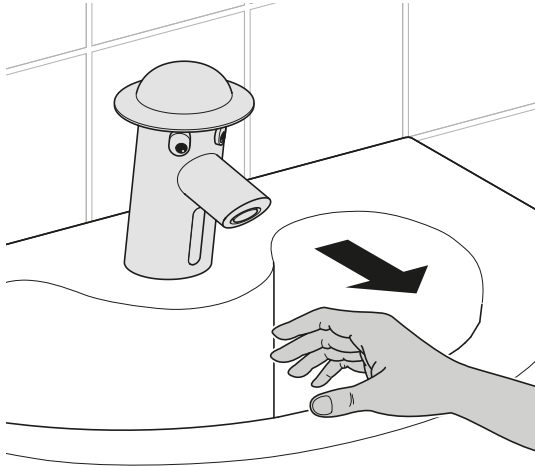

i

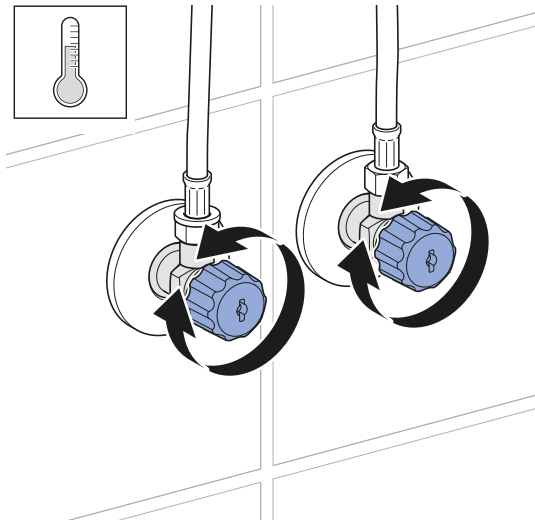

---

Geberit International AG  
Schachenstrasse 77, CH-8645 Jona  
documentation@geberit.com  
www.geberit.com

