

ART. COD.      **A758**

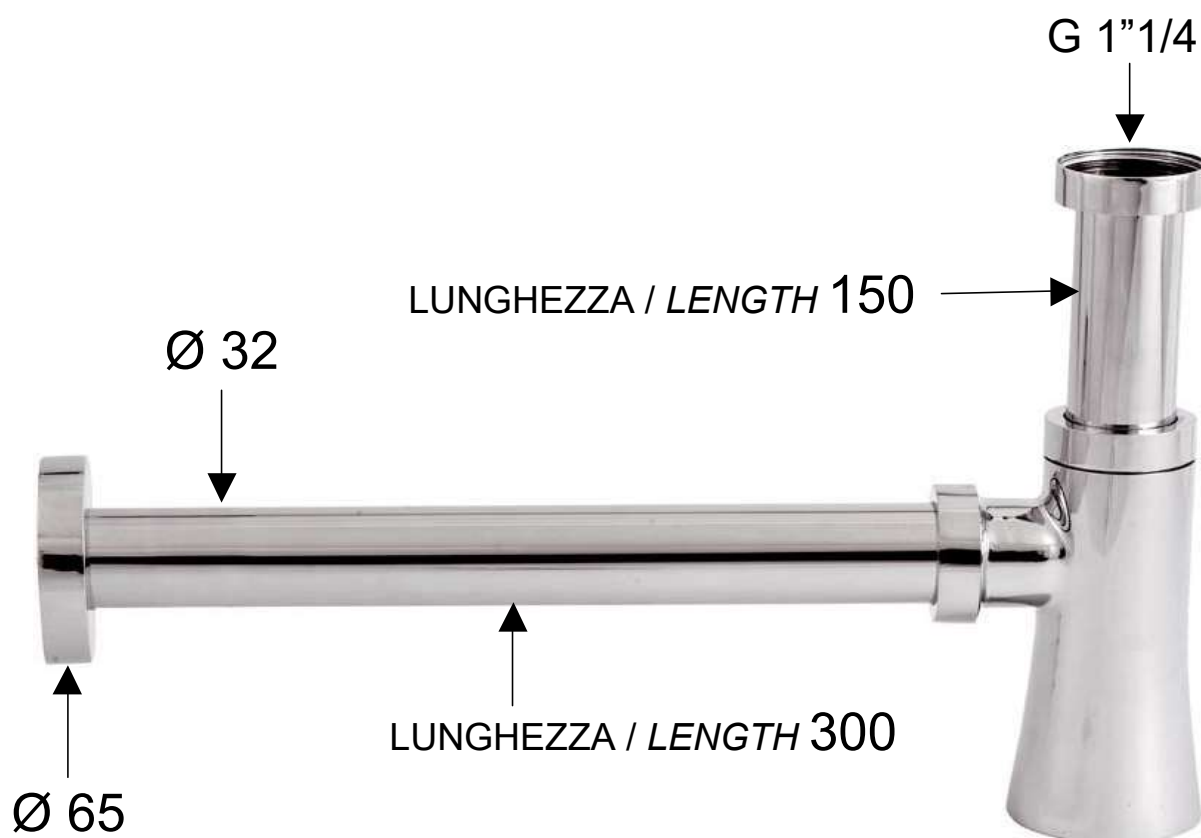

**MATERIALI / MATERIALS**

OTTONE CROMATO / CHROME PLATED BRASS

**CROMATURA / CHROME PLATING**

UNI EN 248