

321-P90-__
Trim Kit for Pressure Balance Valve with Diverter
For use with SS-PB85 concealed rough

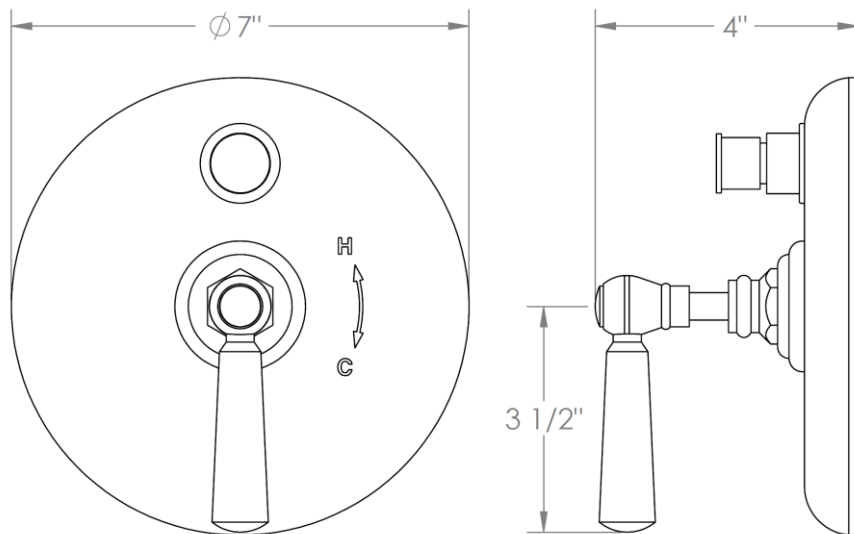

ADDITIONAL HANDLE OPTIONS

S1 - PRESTON

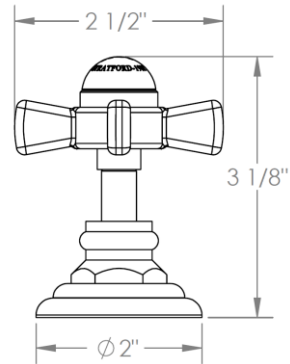

S2 - WALTHAM

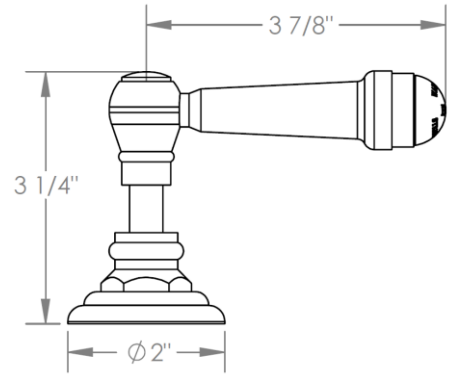

SWA - DARIEN

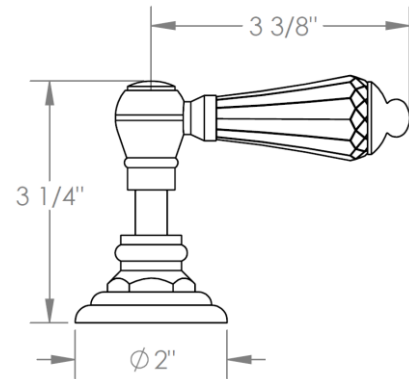

V - WALES

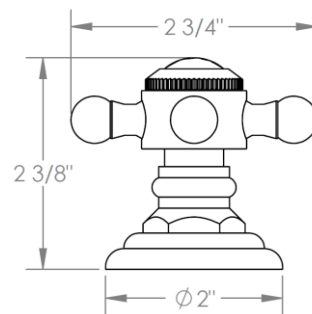

S1A – NOTTINGHAM

