

Sink Foster Milano 1011 050

Sinks

Code: 1011 050



DETAILS

Finish Foster brushed

Material AISI 304 stainless steel

Texture Satin

Base 60 cm

Edge/Installation Type Flush-mount | Top-mount

Dimensions 518x560 mm

Standard fittings Fixing hooks, gasket, drain, overflow and siphon, boxed packing

Mixer holes 2 standard holes

Built-in hole View technical data sheet (for all Flush-mount / Top-mount models and Under-mount models)

Drainer	No
Width	52 cm
Bowl dimension	462x400mm
Number of bowls	1 bowl
Waste fitting	Drain with automatic control SPACE MILANO - 3.5 "

FEATURES

56 cm deep	56 cm deep. An increased dimension synonymous with great functionality, which distinguishes the Foster Milano series.
Automatic waste fitting	The waste-fitting with round remote knob is supplied; a practical accessory which makes it unnecessary to get wet in order to drain the water from the bowl.
Diamond-shape bottom	The draining of water is an important feature in a sink, and it's always taken good care of in Foster products. In the bent-welded sinks, which would have a flat bottom, the proper draining is guaranteed by the elegant beveling, which helps the water flow.
Double mixer hole	The large tap counter is already fitted with a series of 2 tap holes. In the second hole it is possible to install the remote control of the automatic drain or, alternatively, a practical soap dispenser.
High thickness	1mm thick steel. A significant thickness, which guarantees the maximum sturdiness and durability.
Perimetral overflow	The overflow is always a security on the Foster sinks that prevents the overflow of water in case of oversights. The perimeter drain solution improves aesthetics thanks to its square and essential shape.
Save space system	Drain and siphon are designed to leave as much space as possible in the under-sink area, more and more useful today for theseparate waste collection systems.

Space waste fitting

The elegant SPACE steel cap closes the drain and leaves no visible residues collected in the basket below. Space also has a small footprint and allows the optimal use of the under-sink compartment.

Triple recess - sliding accessories

The Foster Milano sink has an ingenious design that makes it simple to use a large set of optional accessories. On the topmost supporting step, the innovative Black grids slide, creating a large and practical surface to rinse food and crockery. The second step is meant to support and allow the sliding of a complete combination of accessories, which make some operations practical and safe: rinse, drain, slice, grate... everything can be done inside the sink. The third supporting step is on the bottom of the bowl. On this step one can rest the Black grids, making it possible to rinse foodstuffs without their coming in contact with the bottom of the sink, which may be dirty.

TECHNICAL DATA

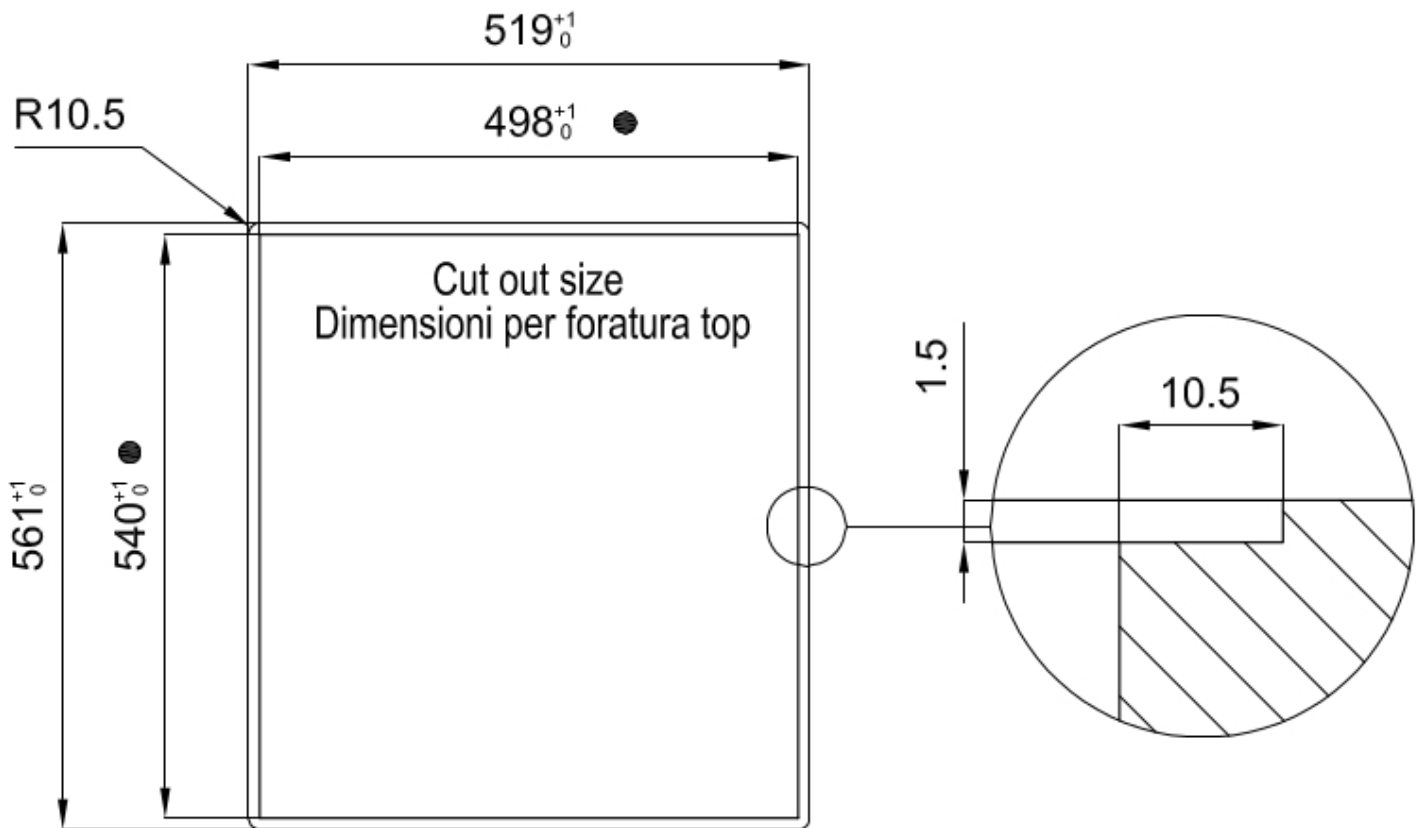

- Built-in cut out for FTS - Foratura per installazione FTS

GALLERY



EQUIPMENT



Space Milano automatic waste fitting 8407 115

OPTIONAL ACCESSORIES



Black grid 8100 600



HPDE Twin chopping board 8644 101

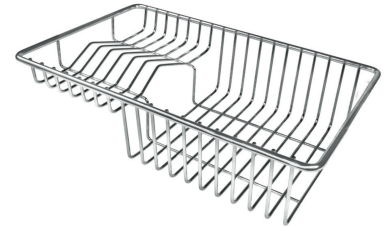

Stainless steel plate rack 8100 303



Walnut-wood chopping board 8642 000



Glass chopping board 8631 300



Graters kit with ring-holder and food collection tray 8159 101



Stainless steel perforated tray 8151 000

WARNING:

The accessories 8159101, 8100303,8151000 are only usable in combination with 8644101

RECOMMENDED PAIRINGS

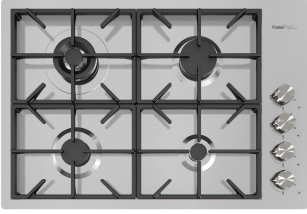

Cooker hob Foster Milano 7637
000



Mixer Tap FL 8521 000