

VOLA 100, 100X, 200, 200V, 300
 VOLA 400DV, 400, 400V, 400N, 400NV, 400T
 VOLA 400TV, 400F, 400FV, 400R, 400RV
 VOLA 2100, 2100X, 2200, 2200V, 2300, 2400
 VOLA 2400V, 2400N, 2400NV, 2400T, 2400TV
 VOLA 2400F, 2400FV, 2400R, 2400RV



Fitting instruction Monteringsvægledning
 Montageanleitung Montage hanledning
 Monteringsvejledning Manuel de montage



www.vola.com
 100-2100_V2_40998502

vola



	L	L1	L2	H	H1	D
100, 100X, 200V, 300, 400V, 400DV 2100, 2100X, 2200V, 2300, 2400V	395 mm 15 1/2"	264 mm 10"	268 mm 10 1/2"			
400NV, 400TV 2400NV, 2400TV	490 mm 19 1/2"	359 mm 14"	367 mm 14 1/2"	95 mm 3 3/4"	170 mm 6 3/4"	70 mm 2 3/4"
400FV, 400RV 2400FV, 2400RV	570 mm 23"	439 mm 17"	447 mm 17 5/8"			



VR968: To be ordered separately.
 Werden separat bestellt.
 Bestilles separat.
 Beställs separat.
 Apart te bestellen.
 À commander séparément.

A Data, 3 Bar/43.5 Psi:

	l/min.	Gal/min.
100:	18,3	4.8
400V:	15,6	4.1
2100:	25,2	6.7
2400V:	22,2	5.9

Max. 65°C, 150°F
 Max.: 10 Bar/145 psi

B Check the local legislation.
 Bitte die örtlichen Vorschriften überprüfen.
 Tjek de lokale regler.
 Kontrollera lokala föreskrifter
 Nazitten lokale regelgeving.
 Vérifiez la législation locale.

C DE: Bitte separat beiliegende Anleitung für die Schalldämpfer VR1249 beachten

D Box till inbyggnadsblandare.
 Boks til indbygningsblander.
 Laatikko seinäsenteiselle sekoittajalle.

Ingår inte i leveransen, köps separat.
 Ikke inkludert, kjøpes separat.
 Eivät sisälly tilaukseen, ostettava erikseen.

Extension
 Verlängerung
 Forlængerdele
 Förlängning
 Aanpassing
 Modification

T Min. 3 mm
 Max 65 mm
 Y Min. 48 mm
 Max. 110 mm

T	Y	VR1260/2260/1400/2019
3 - 15 mm	110 - 98 mm	Std.
15 - 25 mm	98 - 88 mm	+10
25 - 35 mm	88 - 78 mm	+20
35 - 45 mm	78 - 68 mm	+30
45 - 55 mm	68 - 58 mm	+40
55 - 65 mm	58 - 48 mm	+50

Extension, retrofit
 Verlängerung, nachträglicher Einbau
 Forlængerdele, eftermontering
 Förlängning, eftermontering
 Aanpassing na montage
 Modification après installation

X 52 - 0 mm
 X -15 - 0 mm

X	VR1260 + VR1400 + VR2019
40 - 52 mm	Std.
30 - 40 mm	+10
20 - 30 mm	+20
10 - 20 mm	+30
0 - 10 mm	+40
-10 - 0 mm	+50

X	VR2260 + VR1400 + VR2019
35 - 47 mm	Std.
25 - 35 mm	+10
15 - 25 mm	+20
5 - 15 mm	+30
-5 - 5 mm	+40
-15 - -5 mm	+50

Fitting of extension
 Montage von verlängerung
 Monterings af forlængerdele

Montering av förlängning
 Montage van de verlengstukken
 Montage des rallonges





2x13 mm Lightweight wall
 Leichtwand
 Let væg

Lätta konstruktion
 Holle wandconstructie
 Construction légère



1x15 mm
1x18 mm
1x20 mm

Lätta konstruktion
 Holle wandconstructie
 Construction légère



Masonry
 Mauerwerk
 Murværk

Murverk
 Massive wand
 Mur Plein



1

Max. 30 mm
 Max. 1 1/8"

2

Test Pressure
 Prüfdruck
 testtryk
 Test tryck
 Test druk
 test de pression

Check the local legislation.
 Bitte die örtlichen Vorschriften überprüfen.
 Tjek de lokale regler.
 Kontrollera lokala föreskrifter.
 Nazitten lokale regelgeving.
 Vérifiez la législation locale.

1. MAX. 16 Bar
 232 Psi

2. MAX. 4 Bar
 58 Psi

! Water - Wasser - Vand - Vatten - Water - Leau !
! MAX 1 Minute - Minut - Minuut !



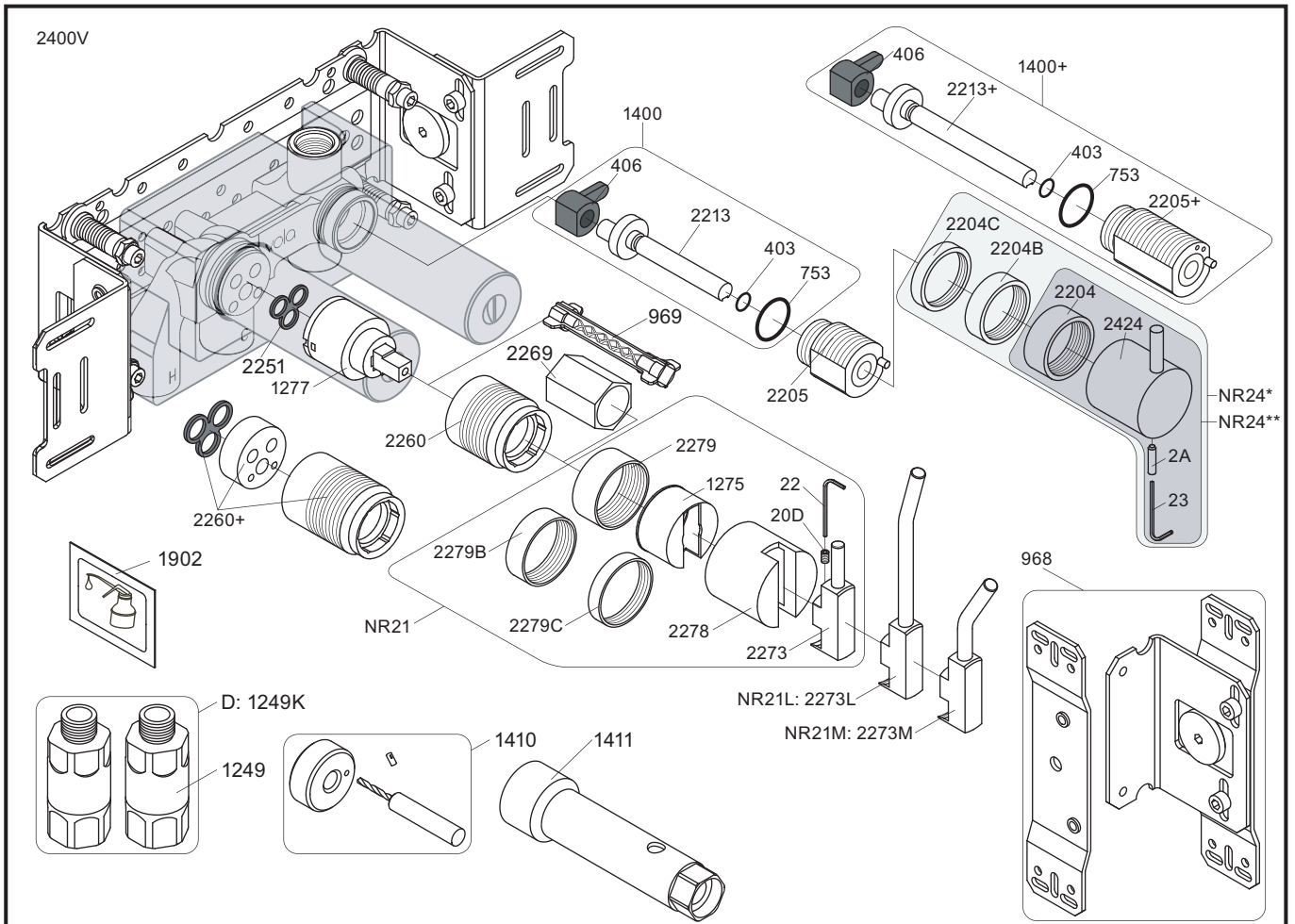

NR21: VR20D, VR22, VR1275, VR2269, VR2273, VR2278, VR2279, VR2279B, VR2279C
 NR24*: VR2A, VR22, VR1419, VR2204, VR2204B, VR2204C - (Brass, Messing, Laiton)
 NR24**: VR2A, VR22, VR1419, VR2204 - (Stainless steel, Edeltstahl, Rustfritt stål, Acier inoxydable)
 VR1277K: VR22, VR2269, VR1277
 VR1400: VR23, VR406, VR753, VR1902, VR2213

2400V

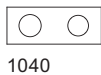
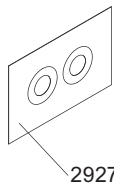
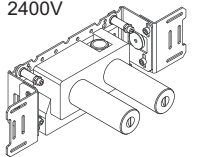

1040



2001, 001G

2400NV

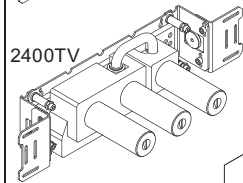
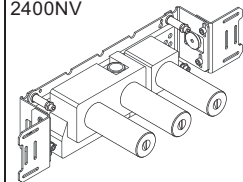

2400TV

2926

2003K



2004



2001, 001, 001G

2400FV

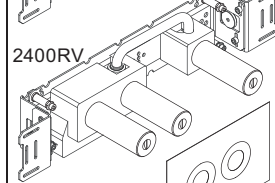
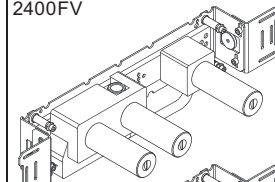

2400RV

2927

2003



2001, 001, 001G

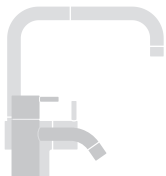

vola

Lunavej 2
 DK-8700 Horsens
 Tlf : + 45 7023 5500
 sales@vola.com
 www.vola.com

VOLA 2400
 2400V/FV/NV/RV/TV

Date
 Apr. 21

Rev.
 4

Sheet
 SB 10.10