

Layout Seat Single - 1LYS1

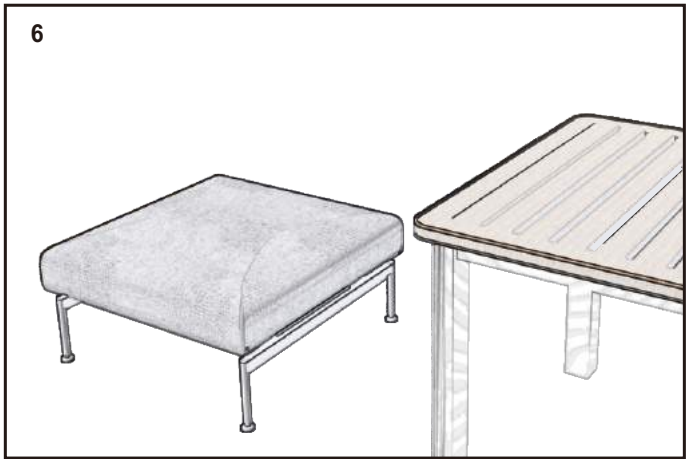

Layout Back Single - 1LYB1

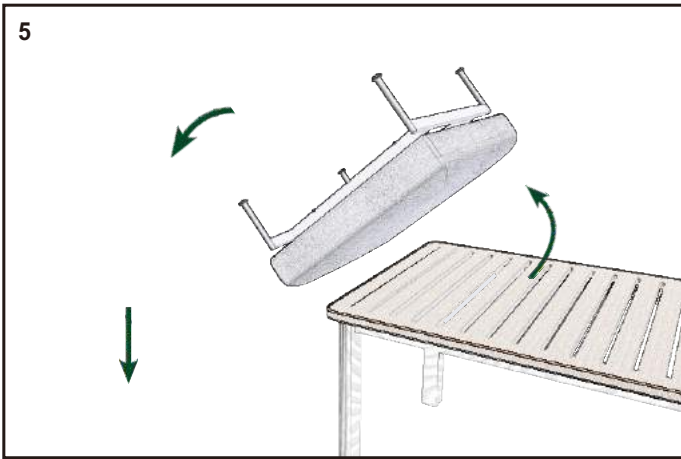
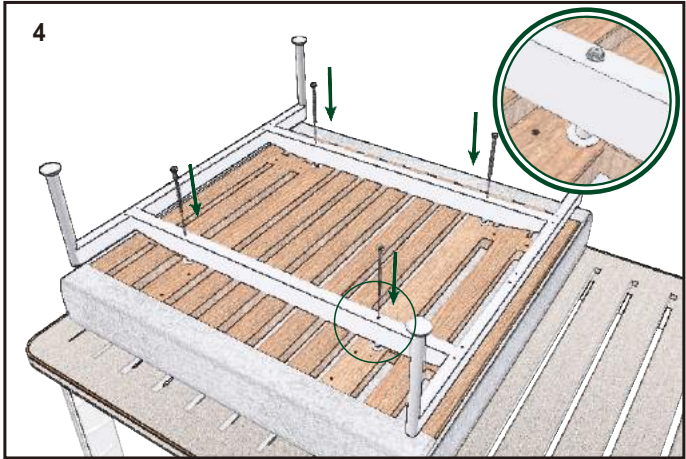
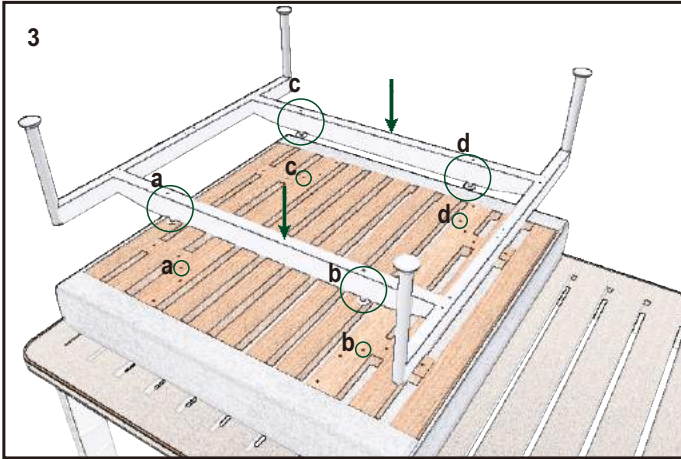
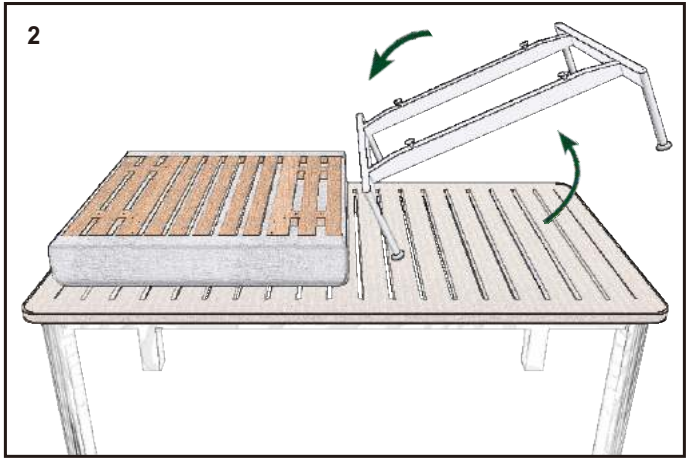
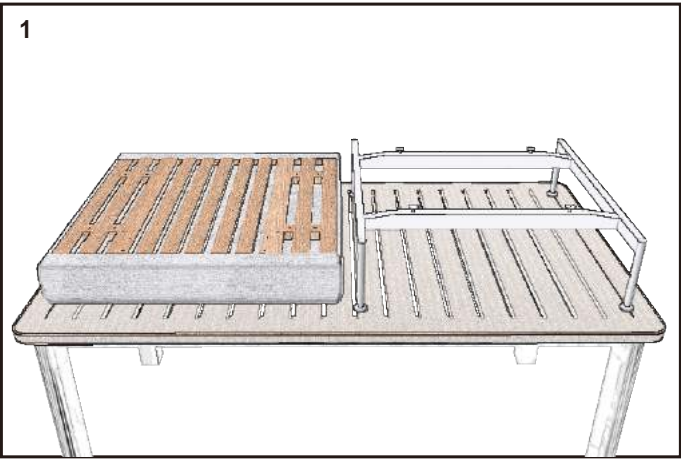
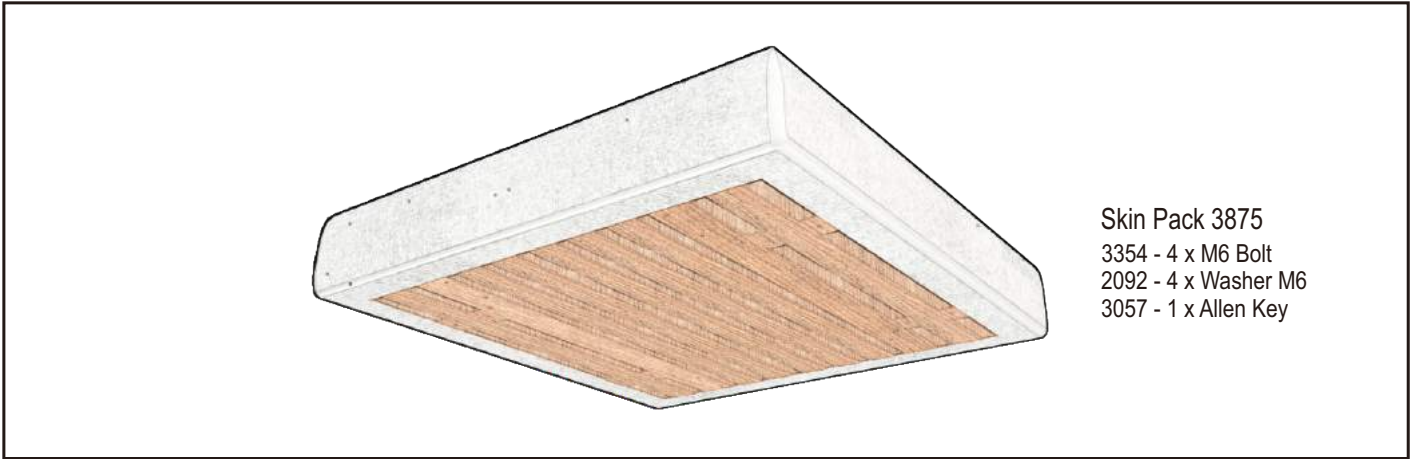
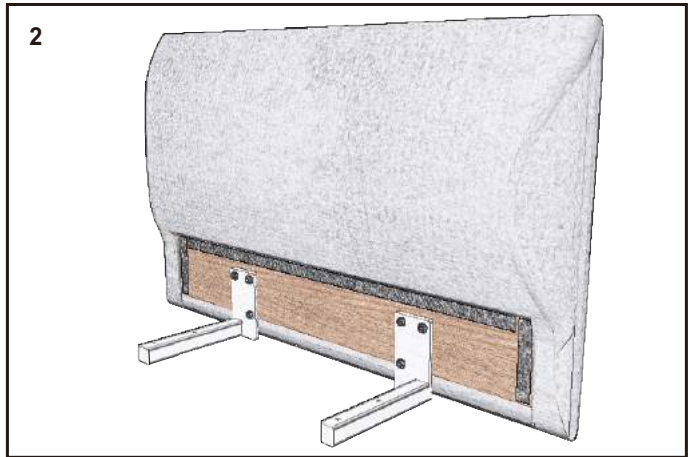
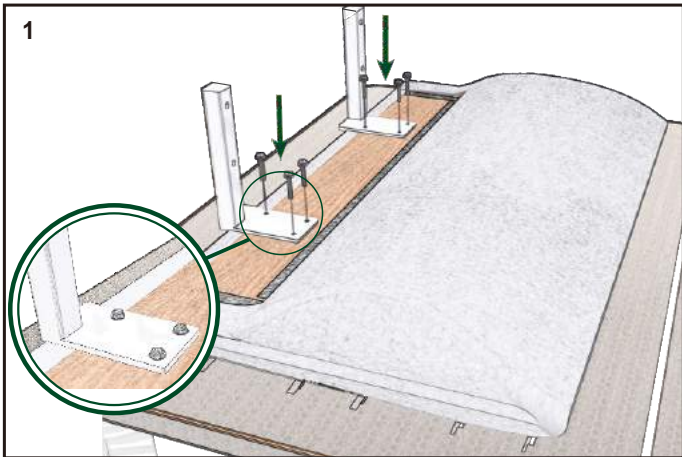
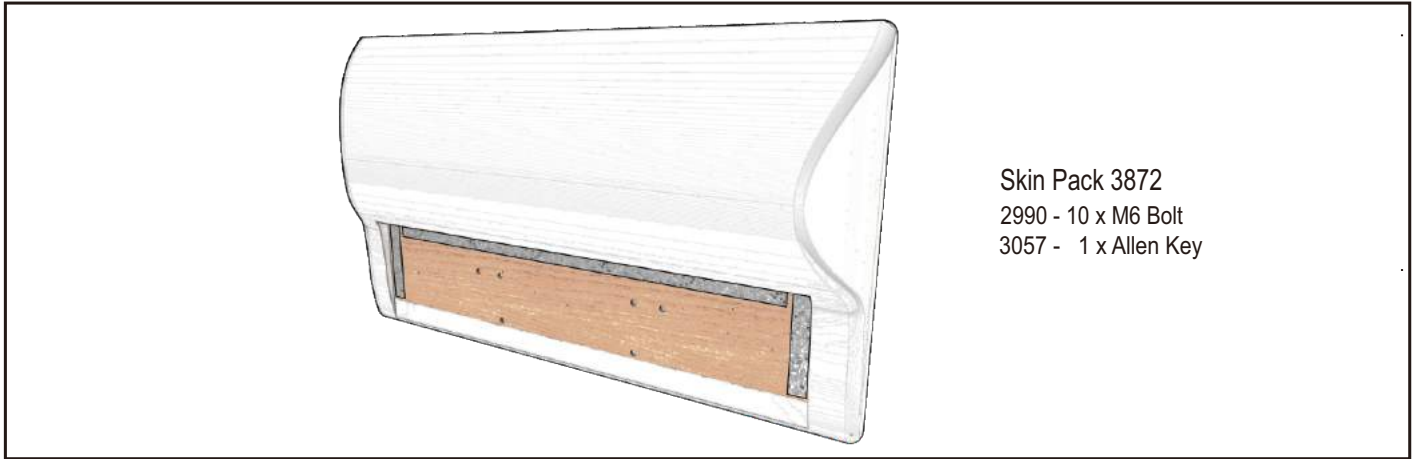

Position the **Back** on the correct side of the seat frame as shown
Note when used as an **Arm** it needs positioning on the adjacent side.

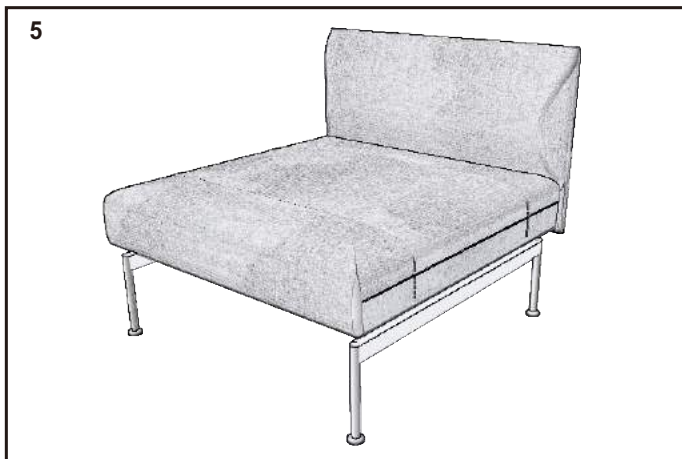
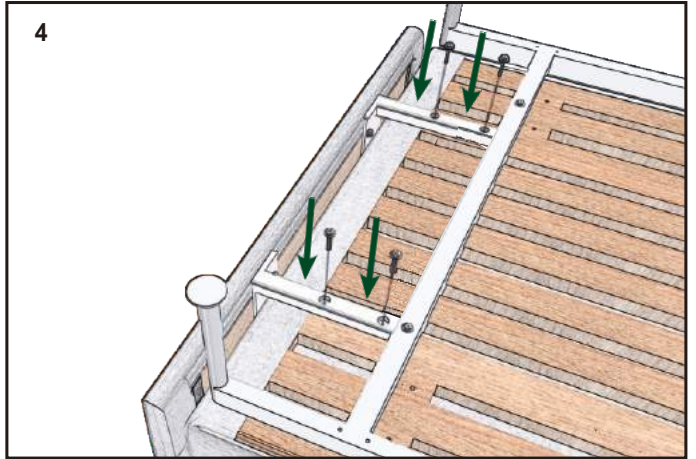
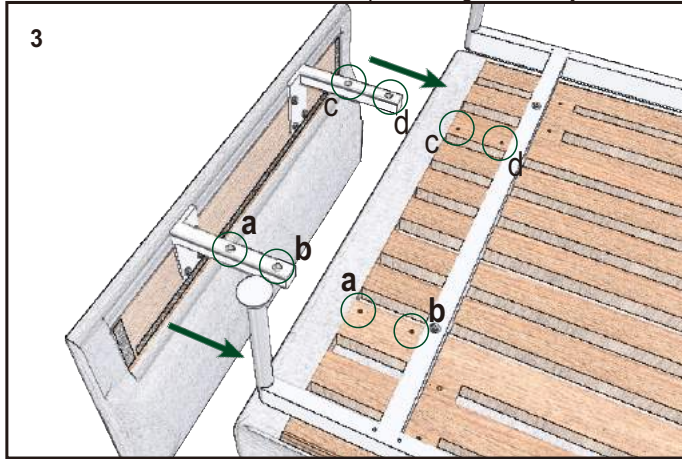

Layout Arm - 1LYA

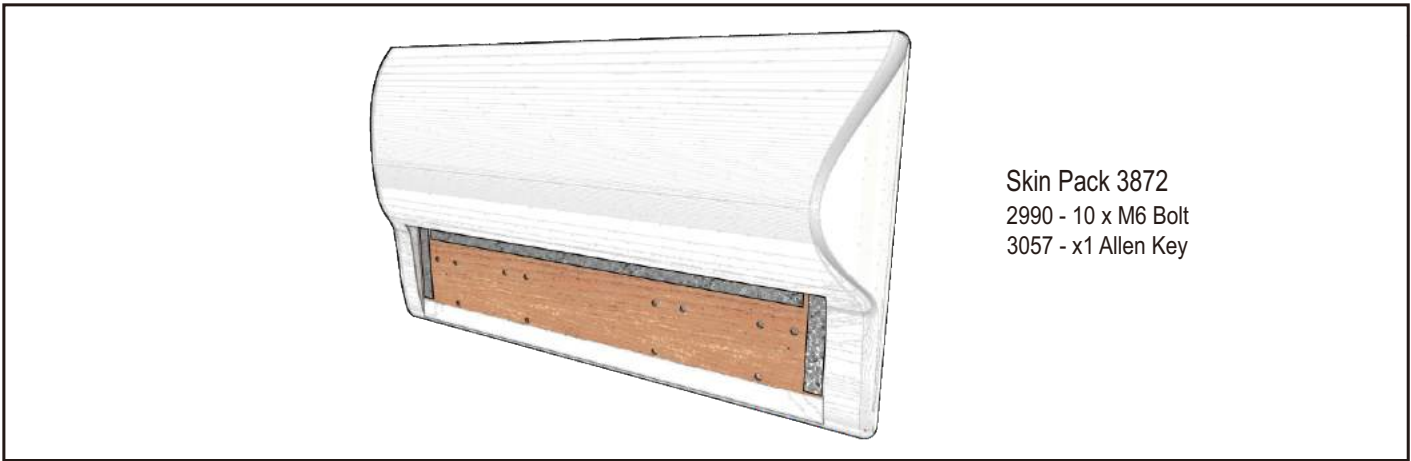

Connector position for **Left** arm when facing the seat

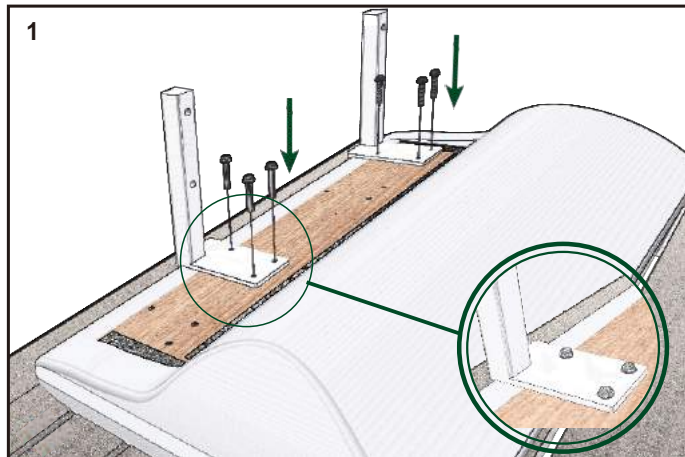

Connector position for **Right** arm when facing the seat

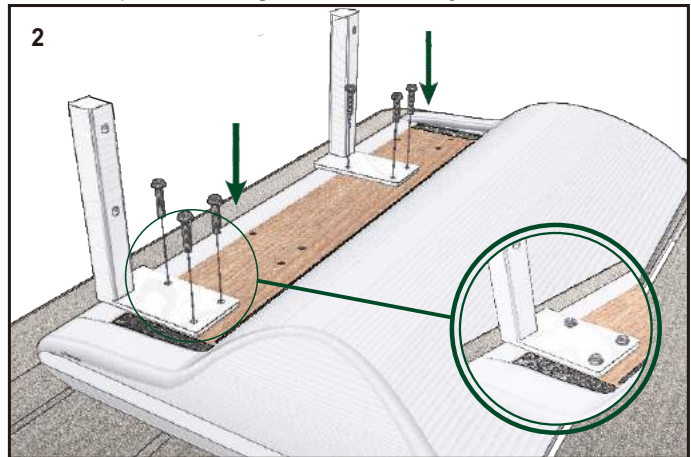

Connector and **Left** arm when facing the seat

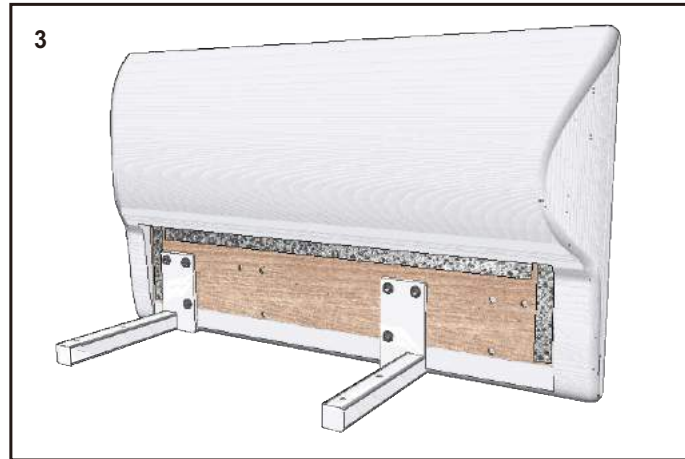

Connector and **Right** arm when facing the seat

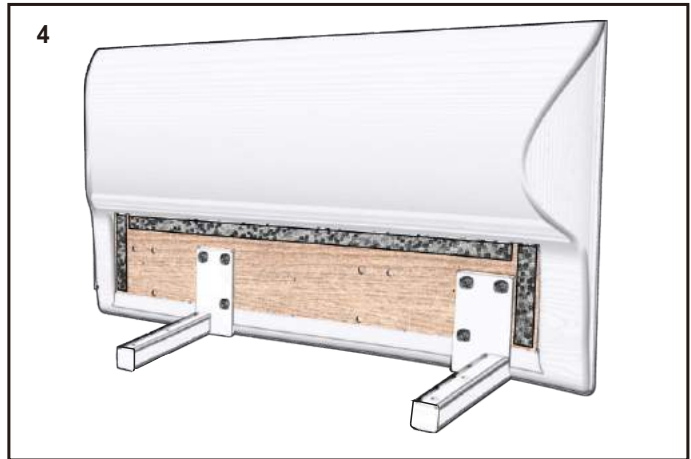

Position the arm on the correct side of the seat frame

