

Easergy P1V

Protection Relay

User Manual

Version: P1V/EN M/1.1
10/2021



Legal Information

The Schneider Electric brand and any trademarks of Schneider Electric SE and its subsidiaries referred to in this guide are the property of Schneider Electric SE or its subsidiaries. All other brands may be trademarks of their respective owners.

This guide and its content are protected under applicable copyright laws and furnished for informational use only. No part of this guide may be reproduced or transmitted in any form or by any means (electronic, mechanical, photocopying, recording, or otherwise), for any purpose, without the prior written permission of Schneider Electric.

Schneider Electric does not grant any right or license for commercial use of the guide or its content, except for a non-exclusive and personal license to consult it on an "as is" basis. Schneider Electric products and equipment should be installed, operated, serviced, and maintained only by qualified personnel.

As standards, specifications, and designs change from time to time, information contained in this guide may be subject to change without notice.

To the extent permitted by applicable law, no responsibility or liability is assumed by Schneider Electric and its subsidiaries for any errors or omissions in the informational content of this material or consequences arising out of or resulting from the use of the information contained herein.

Table of Contents

Legal Information.....	2
General information.....	5
Safety information and password protection	6
Presentation	7
Introduction	7
Identification.....	11
Installation	13
Safety Precautions.....	13
Precautions.....	14
Equipment Receipt and Identification	16
Mounting and Assembly	17
Connectors.....	21
Connection Diagrams	26
Connecting Voltage Transformers (VTs).....	29
Connecting Binary Inputs and Outputs Relays.....	31
Connecting the Communication Port.....	33
Dimensioning the VTs.....	34
Commissioning.....	35
Safety Precautions.....	35
Principles	36
Testing and Metering Equipment Required	38
Energization	40
Validation of the Complete Protection Chain.....	41
Checking Settings.....	42
Checking the VT Ratio.....	43
Checking the Phase Voltage Input Connections	44
Checking the Neutral Voltage Input Connections.....	46
Overvoltage Protection (ANSI 59) Test	47
Neutral Voltage Displacement Protection (ANSI 59N) Test	50
Checking the Logic Input Connections	53
Operational Commissioning.....	54
Easergy P1V Test Sheet	55
Use	62
Human Machine Interface.....	62
Operation	65
Settings.....	68
Password Protection	73
USB Communication Port.....	74
RS485 Communication Port	76
First Steps with eSetup Easergy Pro	77
Menu Map.....	82
Functions and Parameters	90
Line VT Ratio	90
Earth VT Ratio	92
Network Frequency.....	93
Overvoltage Protection [59]	94
Undervoltage Protection [27]	99
Earth Fault Overvoltage Protection [59N].....	102
Overvoltage and Undervoltage Protection Tripping Curves	105
Negative Sequence Overvoltage Protection [47].....	111
Positive Sequence Undervoltage Protection	113
Frequency Protection (81O/81U).....	116
Circuit Breaker Control	119
External Trip (Auxiliary timers).....	122
Logic Discrimination (ANSI 68).....	124
Operating Language	126

Date and Time	127
Password	128
Watchdog Relay.....	132
Circuit Breaker Status Monitoring	133
Circuit Breaker Supervision	134
Local / Remote Mode.....	136
Setting Group Selection.....	139
Commissioning Mode	142
Real Time Clock Synchronization via Opto-Inputs	145
Resetting of Trip Info, Alarms Info, Latched LEDs and Outputs.....	146
Fault and Alarm Records	148
Alarm Status	150
Event Records	151
Measurements and Related Settings.....	153
Counters	154
Disturbance Records	155
Communication	156
Introduction	156
Modbus Protocol.....	157
IEC 60870-5-103 Interface	203
Characteristics.....	213
Function Characteristics	213
Default Settings.....	224
Technical Characteristics.....	236
Environmental Characteristics	240
Maintenance	244
Preventive Maintenance	244
Troubleshooting Assistance.....	245
Removing Easergy P1V.....	247
Application Cases.....	249
3VTs and VN application	249
3VTs and VN with CB Control	250
Logic Discrimination.....	251

General information

Legal notice

Copyright

2021 Schneider Electric. All rights reserved.

Disclaimer

No responsibility is assumed by Schneider Electric for any consequences arising out of the use of this document. This document is not intended as an instruction manual for untrained persons. This document gives instructions on device installation, commissioning and operation. However, the manual cannot cover all conceivable circumstances or include detailed information on all topics. In the event of questions or specific issues, do not take any action without proper authorisation. Contact Schneider Electric and request the necessary information.

Contact information

35 rue Joseph Monier
92500 Rueil-Malmaison
FRANCE
Phone: +33 (0) 1 41 29 70 00
Fax: +33 (0) 1 41 29 71 00
www.se.com

Purpose

This user manual is intended for people who are experts on electrical power engineering, panel builder, commissioner, and experienced users, communication specialists or general users of the Easergy P1 protection relays.

The complete manual is arranged as follows:

- Preliminary sections, with the details of the manual (how to use it, glossary) and technical data.
- Functions of the protection relay.
Explanations, diagrams and settings of the protection, control, monitoring and maintenance, measurement, recording and programmable logic functions are detailed in these sections.
- Installation and commissioning.
- Local control panel use, troubleshooting and maintenance instructions.

The following documents complete this manual:

- Quick Start Guide, delivered in the relay package, summarises instructions for installation.
- Communication Manual, for the understanding and the setup of the communication protocols with Easergy P1 protection relays.



We welcome your comments about this document. You can reach us by contacting Customer Care Centre Contact page:

<http://www.se.com/CCC>

Safety information and password protection

Important information

Read these instructions carefully and look at the equipment to become familiar with the device before trying to install, operate, service or maintain it. The following special messages may appear throughout this manual or on the equipment to warn of potential hazards or to call attention to information that clarifies or simplifies a procedure.

	<p>The addition of this symbol to a "Danger" or "Warning" safety label indicates that an electrical hazard exists which will result in death or serious injury if the instructions are not followed.</p>
	<p>This is the safety alert symbol. It is used to alert you to potential personal injury hazards. Obey all safety messages that follow this symbol to avoid possible injury or death.</p>

 DANGER
<p>DANGER indicates an imminently hazardous situation which, if not avoided, will result in death or serious injury.</p> <p>Failure to follow these instructions will result in death or serious injury.</p>

 WARNING
<p>WARNING indicates a potentially hazardous situation which, if not avoided, can result in death or serious injury.</p> <p>Failure to follow these instructions can result in death, serious injury, or equipment damage.</p>

 CAUTION
<p>CAUTION indicates a potentially hazardous situation which, if not avoided, can result in minor or moderate injury, or equipment damage.</p> <p>Failure to follow these instructions can result in injury or equipment damage.</p>

NOTICE
<p>NOTICE is used to address practices not related to physical injury.</p> <p>Failure to follow these instructions can result in equipment damage.</p>

User qualification

Electrical equipment should be installed, operated, serviced, and maintained only by trained and qualified personnel. No responsibility is assumed by Schneider Electric for any consequences arising out of the use of this material. A qualified person is one who has skills and knowledge related to the construction, installation, and operation of electrical equipment and has received safety training to recognise and avoid the hazards involved.

Use the password protection feature in order to protect untrained person interacting with the Easergy P1 protection relay.

Presentation

Introduction

The Easergy P1V Family

The Easergy P1V is a member of Easergy P1 product family. The Easergy P1V family of protection relays is designed for the protection and operation of MV/LV utility substations and electrical distribution networks in industrial installations. It comprises three models suitable for normal protection applications involving voltage metering:

- Easergy P1V model L (3 + WD relay outputs, without communication port) for overvoltage, neutral overvoltage (based on vector sum $(\vec{V}_a + \vec{V}_b + \vec{V}_c)$) and undervoltage protection,
- Easergy P1V model N (2 binary inputs, 5 + WD relay outputs, with communication port) for overvoltage, neutral overvoltage (based on vector sum $(\vec{V}_a + \vec{V}_b + \vec{V}_c)$) or measurement from open delta), undervoltage, negative sequence overvoltage and external trip (auxiliary timers) protection,
- Easergy P1V model A (6 binary inputs, 7 + WD relay outputs, with communication port) for overvoltage, neutral overvoltage (based on vector sum $(\vec{V}_a + \vec{V}_b + \vec{V}_c)$) or measurement from open delta), undervoltage, negative sequence overvoltage, external trip (auxiliary timers), positive sequence undervoltage and under/over- frequency protection.

Example: Easergy P1V



Main Advantages of Easergy P1V

Easergy P1V is easily installed in a switchboard:

- It is compact with uniquely small installation footprint
- It is held in place in the switchboard by spring clips or screw clamps (fastening elements)
- The connection terminals are clearly identified.

Easergy P1V is quick to commission:

- It comes with default parameters.
- Its settings are entered on the front panel by means of its display and well-designed keypad.
- It can be commissioned without using a PC.
- It can be commissioned with using a PC and dedicated software (eSetup EasergyPro)

Easergy P1V makes it easy to operate substations:

- It has numerous customization options so that it can be adapted to specific operating constraints.
- Its display unit can display screens in several languages.
- It indicates tripping explicitly and spontaneously.

Easergy P1V is a robust product that is easy to maintain:

- The case is made of insulated plastic.
- The unit can withstand harsh environments:
 - Front panel degree of protection: IP54
 - Range of operating temperatures-25°C to +60°C (-13°F to +140°F)

Easergy P1V Applications

Easergy P1V relays provide accurate protection for various applications requiring voltage or voltage and frequency protection. With a focus on tailoring to user's needs, Easergy P1V is offered in 3 hardware model variants. All of them are housed in uniquely small case what:

- **Model L**

Non-communicating, basic under or over voltage protection with derived voltage displacement, fault recording and two setting groups. With only 3 relay output contacts, this model is the most economical option in the range. A good choice for retrofit of older technology devices in medium or low voltage substations.

- **Model N**

Communicating device with basic under or over voltage protection with dedicated earth-fault analog voltage input, negative sequence over voltage protection, event and fault recording, blocking logic and two setting groups. It comprises 2 binary inputs, 6 relay outputs, a front USB and rear RS485 communication port with switchable IEC 60870-5-103 or Modbus protocol. Circuit breaker control is effected via front panel keys or remote communication port. This model is cost-optimised for essential protection functions that require serial communication. Suited to industrial or commercial sites and a good choice for MV/MV or MV/LV substation auxiliary under or over voltage protection or as primary protection for LV substations.

- **Model A**

Communicating device with advanced under or over voltage and under or over frequency protection. It additionally provides positive sequence under voltage protection, event, fault and disturbance recording, CB supervision and VT supervision. It comprises 6 binary inputs, 7 relay outputs, a front USB and rear RS485 communication port. Circuit breaker control is effected via front panel keys, remote communication port or via binary inputs. This model is a complete voltage and frequency protection device housed in uniquely small case. The large number of inputs and outputs allows users to create more advanced schemes for medium and low voltage applications. This model provides the most cost-effective solution for load shedding or restoration and a good choice for retrofit of over or under frequency electromechanical protection relays.

Selection Table

The selection table lists the functions performed by the various Easergy P1V models in standard operation.

	ANSI code	Easergy P1V model		
		L	N	A
Hardware				
Phase voltage inputs		3	3	3
Neutral voltage inputs		-	1	1
Digital inputs		-	2	6
Digital outputs		3+WD	5+WD	7+WD

USB front port with powering		-	1	1
RS485 rear port		-	1	1
Protection functions				
Undervoltage	27	3	3	3
Positive sequence undervoltage	27D	-	-	2
Negative sequence overvoltage	47	-	2	2
Overvoltage	59	3	3	3
Neutral voltage displacement	59N	-	3	3
Derived VN sequence overvoltage	59N	3	3	3
VT supervision	60FL	-	1	1
Over or under frequency	81	-	-	6
Lockout	86	1	1	1
Blocking logic		-	1	1
IDMT curves		15	15	15
Setting groups		2	2	2
Auxiliary timers		-	2	3
Control functions				
Local/remote function		-	•	•
Local control with I/O keys		•	•	•
Remote control with RS485		-	•	•
Remote control with digital inputs		-	-	•
Time Synchronisation with digital input		-	-	•
Measurement				
RMS voltage values		•	•	•
Frequency		-	-	•
Positive sequence of voltage		-	-	•
Negative sequence of voltage		-	•	•
Logs and Records				
Tripping context record		20	20	20
Sequence of event record		-	200	200
Disturbance record		-	-	4 sec
Monitoring functions				
Circuit breaker time supervision		-	-	1
Counters		-	-	1
Self-supervision (WD)		•	•	•

Voltage Measuring Ranges

Two voltage measuring ranges are available as hardware option.

Hardware option	Measuring range
1st	57 – 130 V
2nd	220 – 480 V

Power Supply Voltage

The Easergy P1V power supply voltage can be DC or AC. Three power supply voltage ranges are available, as indicated in the following table:

Easergy P1V model

Power Supply Voltage	L	N	A
24 – 240 V AC 24 – 250 V DC	•	-	-
24 – 60 V AC 24 – 60 V DC	-	•	•
90 – 240 V AC 90 – 250 V DC	-	•	•

Identification

Reference Code

The reference code for a Easergy P1V is an alphanumeric code that defines the Easergy P1V main functions and hardware options. List of available model look as follows:

Model L: 3 voltage inputs, 4 binary outputs, without binary inputs and communication

Cortec no.	Vn	Vx	Catalogue no.
P1V1L10N1N2N0NN11N	Vn = 57-130 Vac	Vx = 24 - 240 Vac and Vx = 24 - 250 Vdc	REL15024
P1V1L10N2N2N0NN11N	Vn = 220 - 480 Vac	Vx = 24 - 240 Vac and Vx = 24 - 250 Vdc	REL15025

Model N: 4 voltage inputs, 6 binary outputs, 2 binary inputs, rear RS485 and front USB port, communication protocol switchable between IEC 60870-5-103 or Modbus.

Cortec no.	Vn	Vx	Catalogue no.
P1V1N11N1N1N1NN11N	Vn = 57-130 Vac	Vx = 24 - 60 Vac/dc	REL15026
P1V1N11N2N1N1NN11N	Vn = 220 - 480 Vac	Vx = 24 - 60 Vac/dc	REL15027
P1V1N11N1N2N1NN11N	Vn = 57-130 Vac	Vx = 90 - 240 Vac and Vx = 90 - 250 Vdc	REL15028
P1V1N11N2N2N1NN11N	Vn = 220 - 480 Vac	Vx = 90 - 240 Vac and Vx = 90 - 250 Vdc	REL15029

Model A: 4 voltage inputs with frequency protection, 8 binary outputs, 6 binary inputs, rear RS485, front USB port with USB powered configuration, communication protocol switchable between IEC 60870-5-103 or Modbus

Cortec no.	Vn	Vx	Catalogue no.
P1V1A11N1N1N1NN11N	Vn = 57-130 Vac	Vx = 24 - 60 Vac/dc	REL15030
P1V1A11N2N1N1NN11N	Vn = 220 - 480 Vac	Vx = 24 - 60 Vac/dc	REL15031
P1V1A11N1N2N1NN11N	Vn = 57-130 Vac	Vx = 90 - 240 Vac and Vx = 90 - 250 Vdc	REL15032
P1V1A11N2N2N1NN11N	Vn = 220 - 480 Vac	Vx = 90 - 240 Vac and Vx = 90 - 250 Vdc	REL15033

For Euroasian Customs Union EAC

Model L: 3 voltage inputs, 4 binary outputs, without binary inputs and communication

Cortec no.	Vn	Vx	Catalogue no.
P1V1L10N1N2N0NN11E	Vn = 57-130 Vac	Vx = 24 - 240 Vac and Vx = 24 - 250 Vdc	REL15024R

Model N: 4 voltage inputs, 6 binary outputs, 2 binary inputs, rear RS485 and front USB port, communication protocol switchable between IEC 60870-5-103 or Modbus.

Cortec no.	Vn	Vx	Catalogue no.
P1V1N11N1N2N1NN11E	Vn = 57-130 Vac	Vx = 90 - 240 Vac and Vx = 90 - 250 Vdc	REL15028R

Model A: 4 voltage inputs with frequency protection, 8 binary outputs, 6 binary inputs, rear RS485, front USB port with USB powered configuration, communication protocol switchable between IEC 60870-5-103 or Modbus

Cortec no.	Vn	Vx	Catalogue no.
P1V1A11N1N2N1NN11E	Vn = 57-130 Vac	Vx = 90 - 240 Vac and Vx = 90 - 250 Vdc	REL15032R

Accessories for Easergy P1 series

Type	Catalogue no.
Adapter for Easergy P1 standard flush mounting case to allow mounting on the wall	REL15039
Front cover with sealing for Easergy P1 standard case avoiding from unauthorised access	REL15040
Spare mounting spring clips for Easergy P1 (standard mounting)	REL15041
Spare mounting screw clamps for Easergy P1 (alternative mounting)	REL15042

Installation

Safety Precautions

Before Starting

You are responsible for compliance with all the existing international and national electrical codes concerning protective grounding of any device.

You should also read the safety precautions described below. These instructions must be followed strictly when installing, servicing or repairing electrical equipment.

DANGER

HAZARD OF ELECTRIC SHOCK, ELECTRIC ARC, BURNS OR EXPLOSION

- Only qualified personnel should install this equipment. Such work should be performed only after reading this entire set of instructions.
- NEVER work alone.
- Turn off all power supplying this equipment before working on or inside it.
- Always use a properly rated voltage sensing device to confirm that all power is off.
- Before performing visual inspections, tests, or maintenance on this equipment:
 - Disconnect all sources of electric power.
 - Assume that all circuits are live until they have been completely de-energized, tested and tagged.
 - Pay particular attention to the design of the power system. Consider all sources of power, including the possibility of back-feeding.
- Beware of potential hazards, wear personal protective equipment, and carefully inspect the work area for tools and objects that may have been left inside the equipment.
- The successful operation of Easergy P1 depends upon proper installation, setting, and operation.
- Setting the Easergy P1 relay requires relevant expertise in the field of electrical network protection. Only competent people who have this expertise are allowed to set this product.

Failure to follow these instructions will result in death or serious injury.

CAUTION

HAZARD OF DAMAGE TO EASERGY

- Before performing Dielectric (Hi-Pot) or Megger testing on any equipment in which the relay is installed, disconnect all input and output wires to the relay. High voltage testing may damage electronic components contained in the relay.
- Do not open the Easergy case. The Easergy P1 relay contains components that are susceptible to electrostatic discharge. It is assembled in specially equipped premises.

Failure to follow these instructions can result in injury or equipment damage.

Precautions

Introduction

Easergy P1V relays are supplied in one of the following ways:

- Individually packaged
- Installed in a cubicle

The transport, handling and storage precautions for Easergy P1V relays vary depending on which of these two methods is used.

Easergy P1V in its Original Packaging

- **Transport**

Easergy P1V relays can be shipped to any destination by all suitable means of transport, without taking any additional precautions.

- **Handling**

Easergy P1V relays can be handled without any particular care and can withstand being dropped from a height of 1 m (3.28 ft).

- **Storage**

An Easergy P1V relay can be stored in its original packaging in a location with the following environmental characteristics:

- Temperature: -30...+70 °C (or -22...+158 °F).
- Humidity ≤ 90%.
- Storage is limited to a maximum of one month if the relative humidity is higher than 93% and the temperature higher than +40 °C (or +104 °F).

For more information, refer to Climatic Requirements in Functions Characteristics chapter Technical Characteristic section.

If the relays are to be stored for an extended period, we recommend the following:

- Do not unpack the Easergy P1V prior to its intended period of use.
- Check the environment and the condition of the packaging annually.

Once the Easergy P1V relay has been unpacked, it should be energized as soon as possible.

Easergy P1V Installed in a Cubicle

- **Transport**

Easergy P1V relays can be transported by all suitable means of transport in the usual conditions for cubicles.

Storage conditions should be taken into consideration for a long period of transport.

- **Handling**

If the cubicle is dropped, check the Easergy P1V's condition by visual inspection and energizing.

- **Storage**

We recommend keeping the cubicle protective packaging for as long as possible.

Easergy P1V relays, like all electronic units, should not be stored in a damp environment for more than a month. They should be energized as quickly as possible. If this is not possible, the cubicle reheating system should be activated.

Easergy P1V Used in a Damp Environment

The temperature/relative humidity factors must be compatible with the Easergy P1V relay's environmental withstand characteristics: Refer to Climatic Requirements in Functions Characteristics chapter Technical Characteristic section.

If the conditions of use are outside the normal zone, special arrangements should be made before commissioning, such as air conditioning of the premises.

Easergy P1V Used in a Polluted Environment

The effect of corrosion on Easergy P1V relays has been tested according to the IEC 60068-2-60 standard under the following "4-gas" test conditions:

- 21 days' duration
- 25 °C (or 77°F), 75% relative humidity
- H₂S (10ppb), SO₂ (200ppb), Cl₂ (10ppb), NO₂ (200ppb)

You are responsible for compliance with all the existing international and national electrical codes concerning protective grounding of any device.

You should also carefully read the safety precautions described below. These instructions must be followed strictly when installing, servicing or repairing electrical equipment.

Equipment Receipt and Identification

Equipment Receipt

The Easergy P1V unit is shipped in a cardboard box which helps to protect it against any knocks received in transport.

On receipt, check that the packaging has not been damaged. If it has, note any anomaly on the delivery slip and inform your supplier.

NOTICE
<p>Our products leave our factory in closed, sealed original packaging. At delivery, if the packaging is opened or the seal is broken, Schneider Electric must be informed.</p> <p>Failure to follow this instruction can result in compromised confidentiality and authenticity of the information contained in the products.</p>

Package Contents

The box contains the following items:

- An Easergy P1V relay
- An instruction sheet providing the main information about installation and use-Quick Start
- A certificate of conformity and tests
- Safety guide
- The bag with mounting accessory (spring clips REL15041 and pouch on LEDs description, optional mounting accessory – fastening elements REL15042)

Identification Label

The identification label on the top of the relays is used to identify the Easergy P1V:

Figure 1. Identification label

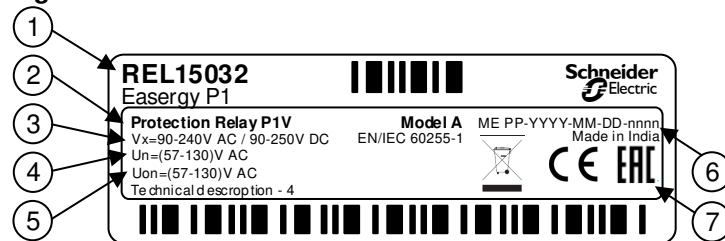

- 1 Reference number
- 2 Device type
- 3 Power supply voltage
- 4 Nominal phase voltage VT input and measuring range
- 5 Nominal neutral voltage input measuring range
- 6 Serial number
- 7 EAC Logo For REL150xxR Commercial References only

For the meaning of the identification codes, refer to Presentation chapter Identification section.

Check After Unpacking

Make sure the delivered Easergy P1V relay corresponds to the product ordered. In particular, check the power supply voltage if it is correct for your installation.

Mounting and Assembly

Introduction

Easergy P1V relays weigh 0.65 kg (1.43 lb.) maximum and are flush-mounted in a mounting plate 1.5 to 4 mm (0.06 to 0.16 in) thick or 4 to 6 mm (0.16 to 0.24 in) depending on method of spring clips mounting direction.

They are designed to be mounted indoors (flush mounting). It is possible to use extra case adapter to wall mounting to which the relay is mounted using fastening element.

To help to ensure a waterproof seal, the surface of the panel must be smooth and solid. The front panel is sealed from behind

Dimensions

Figure 2. Dimensions

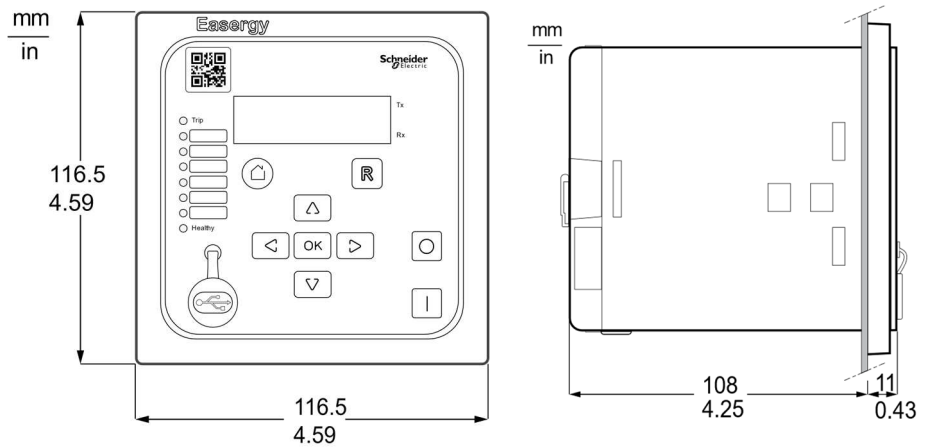

Cut-out

Figure 3. Dimensions of cut out

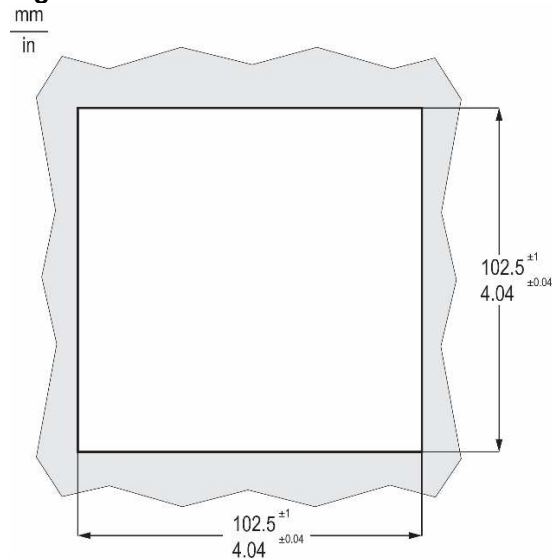

⚠ CAUTION





HAZARD OF CUTS

Trim the edges of the cut-out plates to remove any jagged edges.

Failure to follow these instructions can result in injury or equipment damage.

Installing Easergy P1V

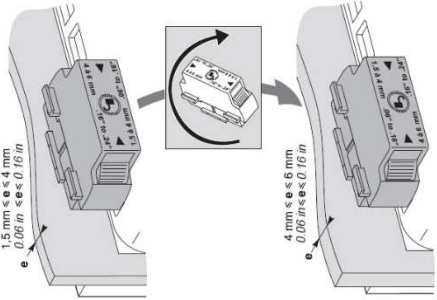
Easergy P1V relay is held in place by 2 catches on the sides, behind the front panel.

Step	Action	Illustration
1	Prepare the relay and the spring clips	
2	Insert the Easergy P1V unit through the cut-out	
3	Verify the thickness of the panel sheet for correct spring clips direction adjustment	
4	Mount the clip and release the springs by pressing the clip trigger, repeat the operation on the other side	

Step	Action	Illustration
5	Make sure the Easergy P1V is mounted firmly	

Removing Easergy P1V

1	To remove the relay unlock spring clips by press until click, so that the spring clips could be taken out (repeat the operation on the other side), and then the relay could be withdrawn from the cut-out in the mounting plate.	
---	---	--

Wall mounted relay

Easergy P1V relay is held in place by 2 catches on the sides, behind the front panel. Flush mounting case of P1V can be mounted on the wall by using optional Wall Mounting Case Adaptor (Figure 4).

Figure 4. P1V Wall Mounting Case Adaptor Dimensions

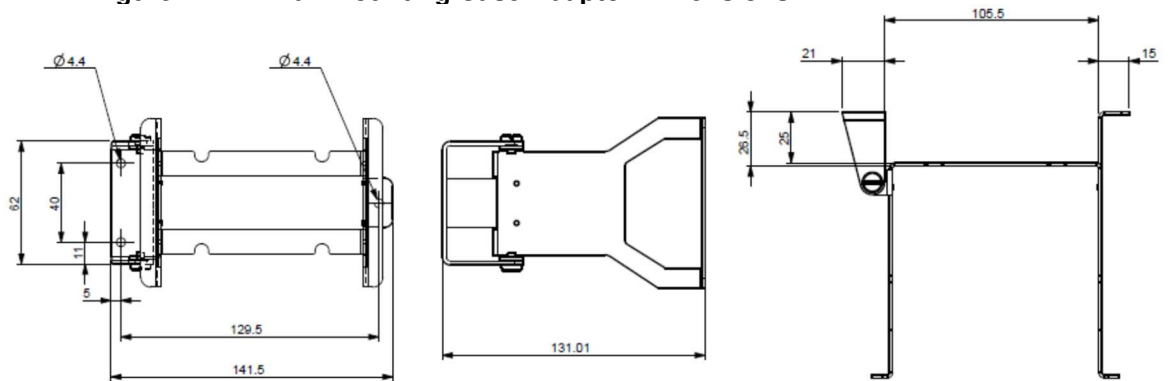

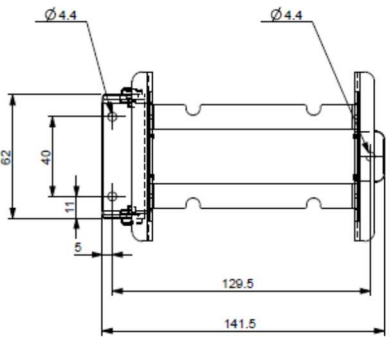
1	Tighten the Adaptor Case in the required place with three M4 screws or equivalent.	
2 - 4	Do the steps 2-4 from Instaling Easergy P1V section (page 18)	

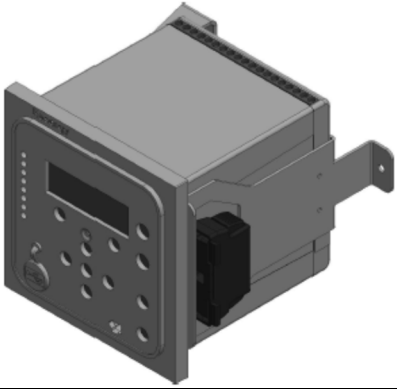
5	Make sure the Easergy P1V is mounted firmly	
6	To remove Easergy P1V from case adaptor do step 1 from section Removing Easergy P1V (page 19)	

Connectors

Introduction

All the Easergy P1V connectors can be accessed on the rear panel.

The wires are fixed using a flat blade screwdriver.

Identification of the Connectors on the Rear Panel

Figure 5. Rear connectors

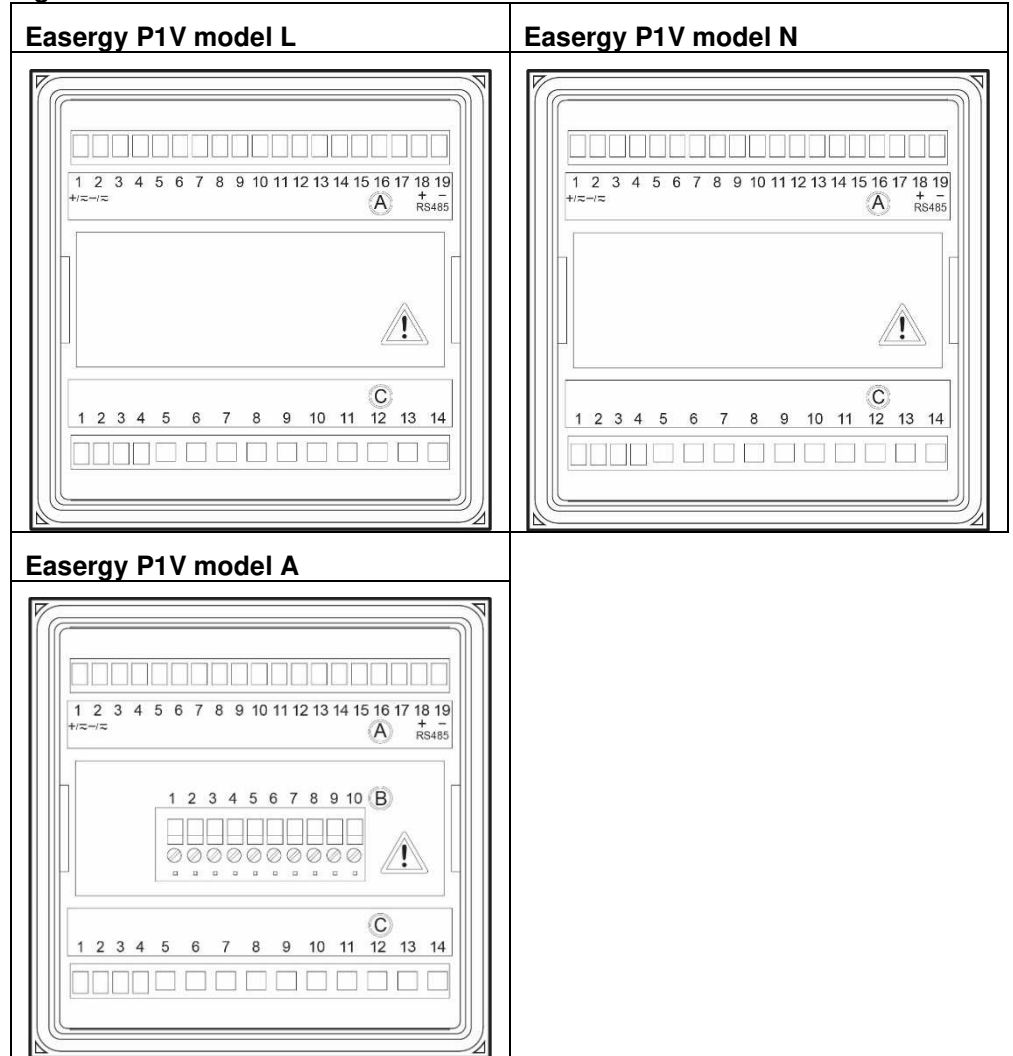

Ref.	Easergy P1V
A	Connector for the auxiliary power supply and WD, relay outputs RL1 to RL3, binary inputs L1 to L2, communication port RS485
B	Connector for the relay outputs RL6 to RL7 and binary inputs L3 to L6
C	Connector for phase to ground or phase to phase voltages inputs, 3Vo voltage input and relay outputs RL4 to RL5.

Connector Wiring

Ref. Terminal block	Wiring	Type of Terminal	Screwdriver	Tightening Torque
A	<ul style="list-style-type: none"> • 0.2 - 4 mm² single-core • 0.2 - 2.5 mm² finely stranded 	M3	3.0 mm flat blade (0.12 in)	0.6 Nm (5.31 lb.-in)
B	<ul style="list-style-type: none"> • 0.2 - 4 mm² single-core • 0.2 - 2.5 mm² finely stranded 	M3	3.0 mm flat blade (0.12 in)	0.6 Nm (5.31 lb.-in)
C AC voltage inputs, relay outputs terminals	<ul style="list-style-type: none"> • 0.2 - 4 mm² single-core • 0.2 - 2.5 mm² finely stranded 	M3	3.0 mm flat blade (0.12 in)	0.6 Nm (5.31 lb.-in)

Terminal Block A Connections

Figure 6. Terminal block A connections

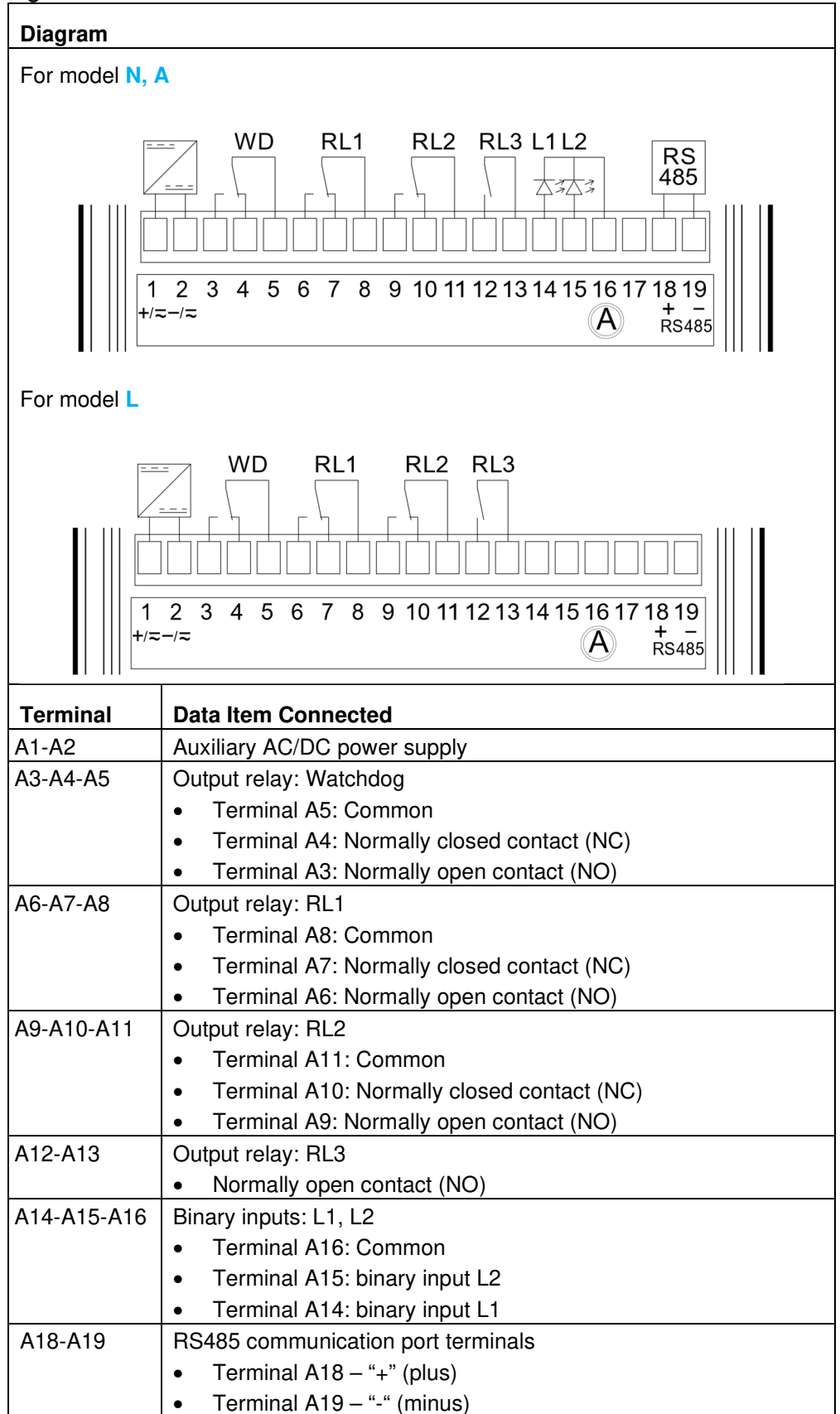

Terminal Block B Connections

Figure 7. Terminal block B connections

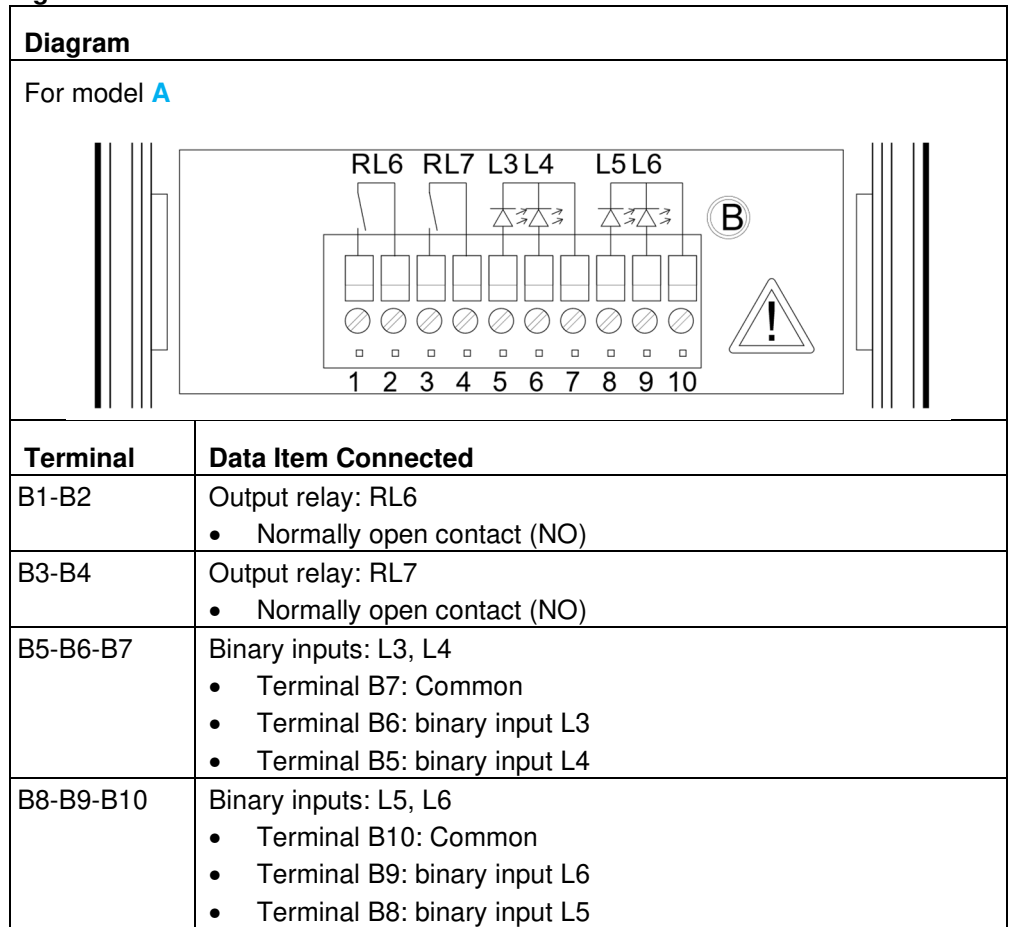

Terminal Block C Connections

Figure 8. Terminal block C connections

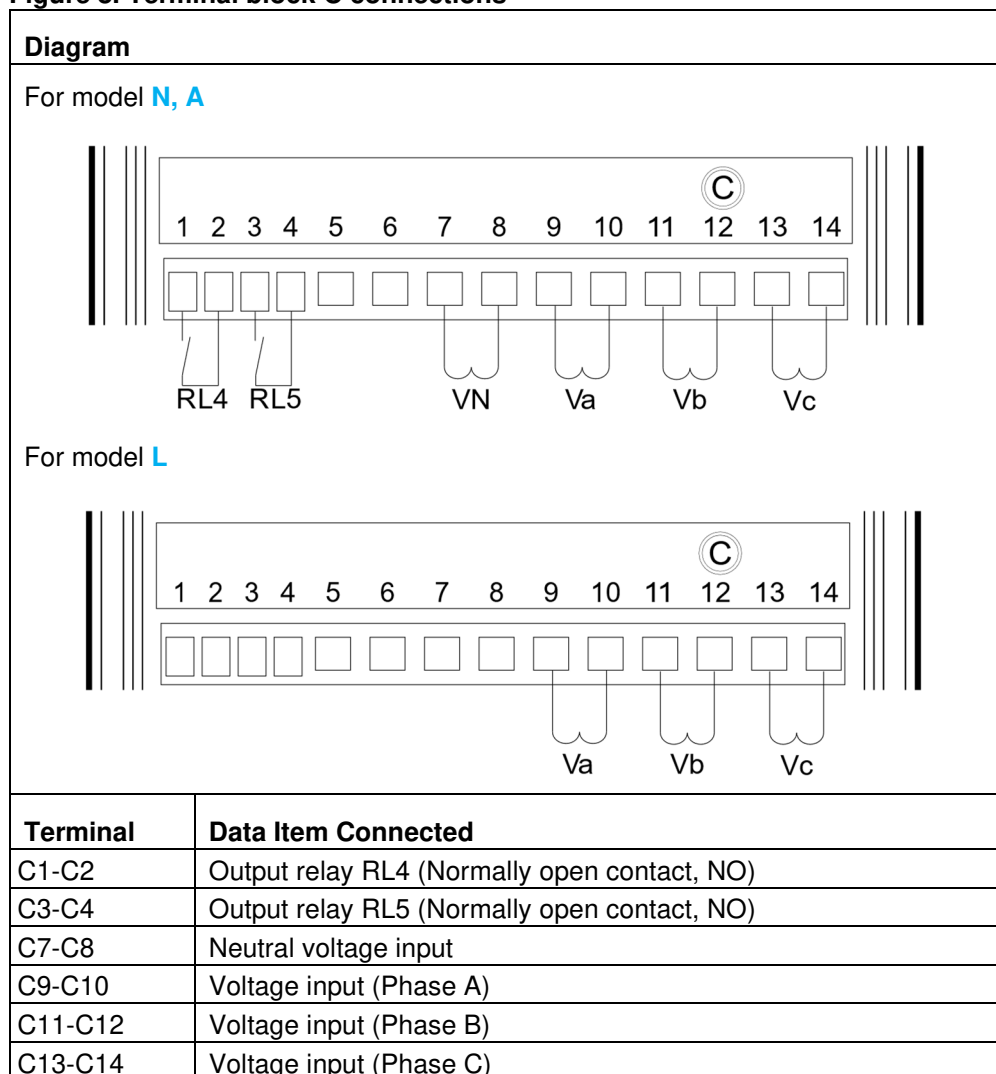

Connection Diagrams

General Safety Precautions

DANGER

HAZARD OF ELECTRIC SHOCK, ELECTRIC ARC OR BURNS

- Only qualified personnel should install this equipment. Such work should be performed only after reading this entire set of instructions and checking the technical characteristics of the device.
- NEVER work alone.
- Turn off all power supplying this equipment before working on or inside it. Consider all sources of power, including the possibility of backfeeding.
- Always use a properly rated voltage sensing device to confirm that all power is off.
- Wear insulating gloves to avoid any contact with a conductor that has accidentally been energized.
- Screw tight all terminals, even those not in use.

Failure to follow these instructions will result in death or serious injury.

Earthing

The earth terminal is not required for the Easergy P1V devices due to the plastic casing.

Easergy P1V models

Each model (L, N, A) Easergy P1V relays depending on the hardware option measure the following voltages:

- 57 - 130 VAC hardware option
 - Phase voltages measured by 3 phase VTs
 - Phase to phase voltages measured by 2 or 3 phase VTs
 - Neutral voltage:
 - measured from open delta (N, A),
 - derived – calculated as vector $(\vec{V}_a + \vec{V}_b + \vec{V}_c)$ sum (L, N, A).
- 220 - 480 VAC hardware option
 - Phase voltages (direct measurement)
 - 2 or 3 phase to phase voltages (direct measurement)
 - Neutral voltage:
 - derived – calculated as vector $(\vec{V}_a + \vec{V}_b + \vec{V}_c)$ sum (L, N, A).

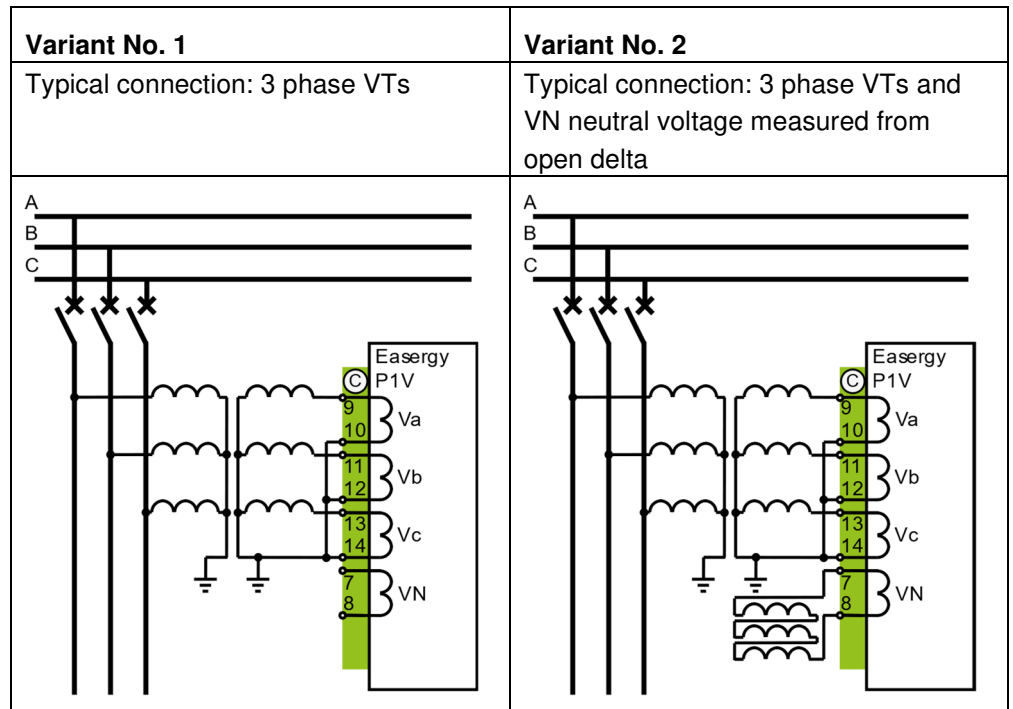

<p>Variant No. 3</p> <p>Typical connection: 2 phase to phase VTs, and VN neutral voltage measured from open delta</p>	<p>Variant No. 4</p> <p>Typical connection: 3 phase to phase VTs, and VN neutral voltage measured from open delta</p>
<p>Variant No. 5</p> <p>Typical connection: 3 Phase voltages, 220 - 480 VAC hardware option (direct measurement)</p>	<p>Variant No. 6</p> <p>Typical connection: 3 phase to phase voltages, 220 - 480 VAC hardware option (direct measurement)</p>

Connecting Voltage Transformers (VTs)

Connecting

Standard 100 V or 110 V voltage transformers (VTs) can be connected to Easergy P1V, to measure phase voltages, phase to phase voltages and neutral voltage VN.

To determine the VT, refer to *Dimensioning the VTs of this chapter*, page 34.

Connection Example

The diagram below shows the connection of:

- 3 phase VTs to measure phase voltages
- Open delta circuit to measure the neutral voltage VN

Figure 9. Connecting voltage transformers diagram

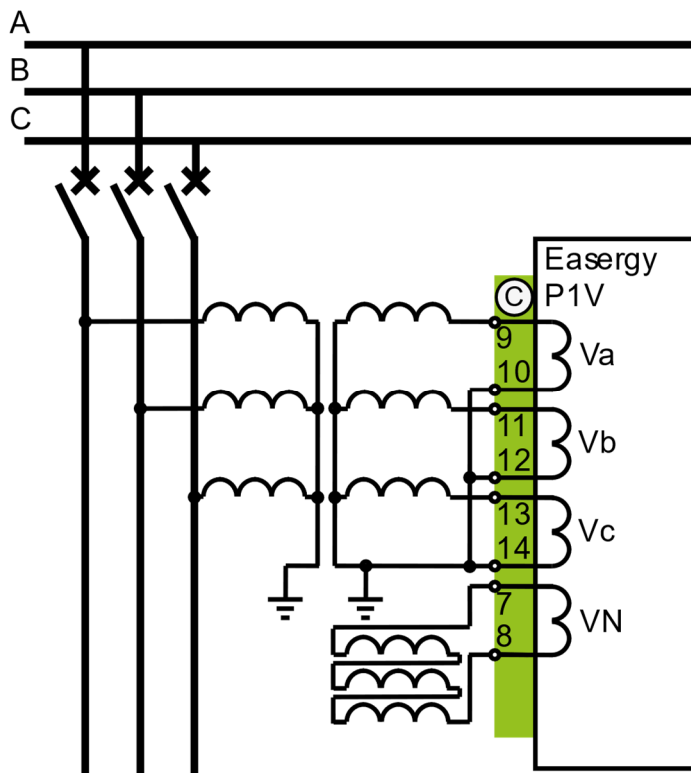

Connection Precautions

- In the cubicle VT compartment, check that the common points of the VT secondaries are connected, using wires of equal length and as short as possible, to a copper bar with a rectangular cross-section connected to the cubicle protective earth.
- Flatten the cable against the metal frames of the cubicle.

If you need to disconnect the Easergy P1V voltage inputs:

DANGER

HAZARD OF ELECTRIC SHOCK, ELECTRIC ARC OR BURNS

- Wear insulating gloves to avoid any contact with a conductor that has accidentally been energized.

Failure to follow these instructions will result in death or serious injury.

Recommended Cable

The cross-section of the cable for connecting the VTs must be selected according to the characteristics of the VT secondary and the length of the link so as to limit the wiring energy consumption.

For more information, refer to *Dimensioning the VTs*, page 34.

Connecting Binary Inputs and Outputs Relays

Safety Precautions

DANGER

HAZARDOUS VOLTAGE

Do not allow hazardous live voltages to coexist with voltages that could be connected to accessible parts (SELV, PELV or PEB) on power supply and I/O block terminals A, B and C. The logic inputs and output relays are isolated from one another with simple isolation.

Failure to follow these instructions will result in death or serious injury.

CAUTION

RISK OF DAMAGE TO THE I/O

Do not supply the logic inputs and relay outputs from sources of power that could come from different phases of a 3-phase supply.

Failure to follow these instructions can result in injury or equipment damage.

Connecting the Output Relays

The Easergy P1V output relays have volt-free contacts.

CAUTION

LOSS OF PROTECTION OR RISK OF NUISANCE TRIPPING

If the Easergy P1V is no longer supplied with power or is in fail-safe position, the protection functions are no longer active and all the Easergy P1V output relays are de-energized. Check that this operating mode and the watchdog relay wiring are compatible with your installation.

Failure to follow these instructions can result in injury or equipment damage.

Connecting the Logic Inputs

The Easergy P1V logic inputs are volt-free.

The Easergy P1V power supply voltage determines:

- The logic input supply voltage range
- The logic input switching threshold

Easergy P1V binary inputs can be triggered both with AC or DC voltage signals.

Advice on Connecting Logic Inputs

To reduce the consequences of electromagnetic disturbance, there should not be a loop between live conductors contained in a single connection. A connection made with a twisted pair helps to ensure that the outward and return conductors remain in close proximity along the whole length of the connection.

Figure 10. Correct and not correct connecting the logic inputs

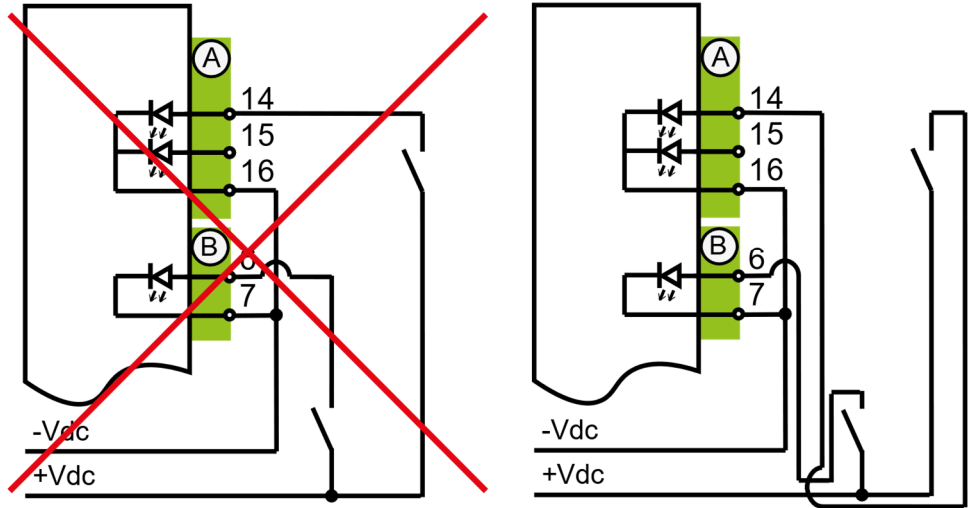

Connecting the Communication Port

Introduction

Easergy P1V can communicate using a 2-wire RS 485 EIA communication port. Connection to the bus is direct, and needs no accessories.

Connection Diagram

Connection is in a daisy-chain and requires a line termination resistor.

Figure 11. RS485 connection diagram

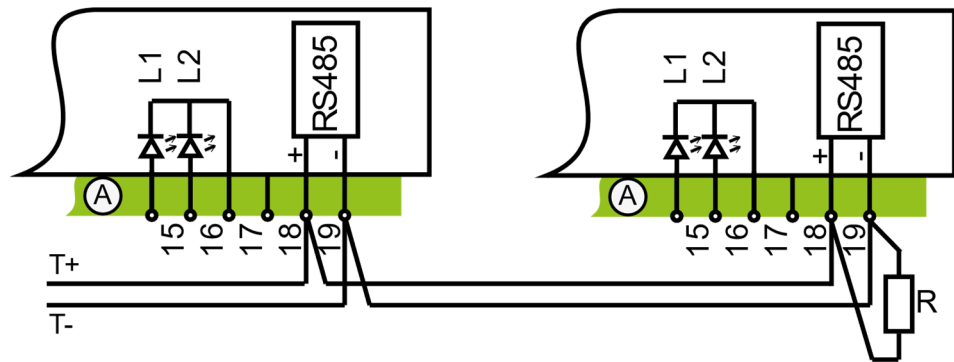

Terminal	Data Item Connected	Description
A18	T+	Connected to terminal (+) of the SCADA communication port
A19	T-	Connected to terminal (-) of the SCADA communication port

Connection Precautions

The number of connected Easergy P1V relays must not exceed 32 and the total cable length must not exceed 1300 m (4265 ft).

The cable shielding connection must also be as short as possible.

If the Easergy P1V is at the end of the line, install a 120 Ω impedance matching resistor between terminals A18 and A19.

Dimensioning the VTs

Introduction

The Easergy P1V phase voltage inputs can be connected to standard 100 V or 110 V VTs (for hardware option 57 – 130 V).

VTs Requirements

In choosing the VT for use with the Easergy P1V relays, it is only necessary to consider the accuracy requirements and the output burden of the VT is sufficient to supply the relay demands. Protection classes 3P or 6P are usually adequate in terms of accuracy but care should be taken that the VT is not over-sized as this may lead to resonance problems. Typically, the output burden of the VT could be 10% higher than the total connected burden of all connected devices

Mounting Precaution

DANGER

HAZARD OF ELECTRIC SHOCK, ELECTRIC ARC OR BURNS

Only qualified personnel should install this equipment. Such work should be performed only after reading this entire set of instructions and checking the technical characteristics of the device.

- NEVER work alone.
- Turn off all power supplying this equipment before working on or inside it. Consider all sources of power, including the possibility of backfeeding.
- Always use a properly rated voltage sensing device to confirm that all power is off.
- Screw tight all terminals, even those not in use.
- Cables with a rated voltage of more than 1000 V must also have shielding connected to the protective earth.

Failure to follow these instructions will result in death or serious injury.

Commissioning

Safety Precautions

Before Starting

You are responsible for compliance with all the existing international and national electrical codes concerning protective grounding of any device.

You should also read the safety precautions described below. These instructions must be followed strictly when installing, servicing or repairing electrical equipment.

DANGER

HAZARD OF ELECTRIC SHOCK, ELECTRIC ARC, BURNS OR EXPLOSION

- Only qualified personnel should install this equipment. Such work should be performed only after reading this entire set of instructions.
- NEVER work alone.
- Turn off all power supplying this equipment before working on or inside it.
- Always use a properly rated voltage sensing device to confirm that all power is off.
- Before performing visual inspections, tests, or maintenance on this equipment:
 - Disconnect all sources of electric power.
 - Assume that all circuits are live until they have been completely de-energized, tested and tagged.
 - Pay particular attention to the design of the power system. Consider all sources of power, including the possibility of back-feeding.
- Beware of potential hazards, wear personal protective equipment, and carefully inspect the work area for tools and objects that may have been left inside the equipment.
- The successful operation of Easergy P1 depends upon proper installation, setting, and operation.
- Setting the Easergy P1 relay requires relevant expertise in the field of electrical network protection. Only competent people who have this expertise are allowed to set this product.

Failure to follow these instructions will result in death or serious injury.

CAUTION

HAZARD OF DAMAGE TO EASERGY

- Before performing Dielectric (Hi-Pot) or Megger testing on any equipment in which the relay is installed, disconnect all input and output wires to the relay. High voltage testing may damage electronic components contained in the relay.
- Do not open the Easergy case. The Easergy P1 relay contains components that are susceptible to electrostatic discharge. It is assembled in specially equipped premises.

Failure to follow these instructions can result in injury or equipment damage.

Principles

Easergy P1V Tests

Protection relays are tested prior to commissioning, with the dual aim of maximizing availability and minimizing the risk of malfunction of the assembly being commissioned. The question is to define the list of tests required at the time of commissioning.

Protection relays based on electromechanical and solid state technologies, whose performance cannot be fully reproduced, must be systematically submitted to detailed testing, not only to test their operational performance, but also to check that they are in good working order and have the required level of performance.

These tests are not necessary for relays based on digital technology:

- The use of this technology helps to ensure reproducibility of the stated performances.
- An internal self-testing system provides continuous information on the state of the electronic components and the integrity of the functions, thereby helping to ensure a high level of availability.

Each of the Easergy P1V functions has undergone full factory performance testing. The Easergy P1V relay is therefore ready to operate without requiring any additional performance testing that concerns it directly.

Commissioning Easergy P1V Relays

The preliminary Easergy P1V commissioning tests can therefore be limited to a commissioning check, i.e.:

- Only carrying out the checks specific to the hardware configuration and the functions activated
- Checking compliance with BOMs and hardware installation diagrams and rules during a preliminary general check
- Checking compliance of the general settings and protection settings entered with the preliminary studies
- Checking connections of the voltage inputs by secondary injection tests
- Checking the VT ratio
- Checking connection of the logic inputs and output relays by simulating input data and forcing the output relay status
- Validating the complete protection chain
- Using the test sheet provided to record the results of the commissioning tests

The Commissioning chapter describes the simple but exhaustive procedure to apply when performing these checks.

It is no longer essential to test each individual protection or control and monitoring function. However, if it does prove necessary to test a function, the test procedures are described in this chapter.

Which Tests Do You Need to Perform?

Not all the checks and tests described in this chapter apply to all Easergy P1V models (L, N, A). Each check or test begins with indicating which Easergy P1V models it applies to: it does not apply to models whose identifier (L, N, A) has a bar over it.

Example

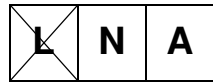

means that the check or test only applies to Easergy P1V model N and A

Testing and Metering Equipment Required

Voltage Generator

To check the voltage input connections, use a sinusoidal AC voltage generator of the following type:

- 50 or 60 Hz frequency (according to the country of use)
- Single-phase (as minimum), adjustable from 0 to 130 V RMS (or 0 to 480 V RMS)
- Three-phases (recommended), adjustable from 0 to 130 V RMS (or 0 to 480 V RMS) per phase
- With injection-controlled digital chronometer, accurate to 10 ms
- With connector suited to the built-in test terminal block in the voltage input connection diagram

If the voltage generator is equipped with electronic on/off controls, check that the voltage is definitely zero in the automatic stop position (depending on the cursor position, the solid state contactor can allow more than 5% of the voltage to flow through).

To check that the Easergy P1V (N, A) logic inputs are connected correctly use one of the following:

- A DC voltage generator, adjustable from 0 to 200 V DC for adaptation to the voltage level of the tested input
- A DC voltage auxiliary power supply the same as the Easergy P1V auxiliary supply voltage

Accessories

Accessories are required for the following connections:

- A plug with cord corresponding to the test terminal block for installed voltages
- An electric cord with clamps, wire grip or touch probes

Metering Devices

Class 1 metering devices are required:

- A voltmeter (0 to 250 V RMS or 0 to 1 kV RMS)

Documents

The set of installation documents includes:

- The complete Easergy P1V connection diagram, showing:
 - Connection of the phase or phase to phase voltage inputs to the corresponding VTs via the test terminal block
 - Connection of the neutral voltage input
 - Connection of the logic inputs and output relays
- The hardware bill of material and installation rules
- The settings sheet with all the Easergy P1V parameters and settings
- The test sheets

Tolerances and Injection Limits

- Minimum injection voltage:
 - 0,2 V for model with directional eart fault protection,
 - 2 V for hardware option 57-130 V,
 - 10 V for hardware option 220-480 V
- Maximum injection voltage:
 - Continuous:
 - 135 V for model with directional eart fault protection,
 - 200 V for hardware option 57-130 V,
 - 720 V for hardware option 220-480 V.
 - For 10 seconds:
 - 200 V for model with directional eart fault protection,
 - 300 V for hardware option 57-130 V,
 - 1300 V for hardware option 220-480 V.
- Frequency: 50 Hz +/- 10% or 60 Hz +/- 10%.

Energization

Checks to be Performed Prior to Energization

Apart from the mechanical state of the equipment, use the diagrams and BOMs provided by the contractor to check:

- The Easergy P1V label
- Conformity of the Easergy P1V power supply voltage (indicated on the identification label on the front panel) with the power supply voltage of the switchboard (or cubicle)
- Correct connection of the auxiliary power supply:
- The presence of test terminal blocks upstream from the voltage inputs
- Conformity of connections between the Easergy P1V terminals and the test terminal blocks

Checking the Connections

With the equipment de-energized, check that the connections are tightened.

Energization Procedure

1. Switch on the auxiliary power supply.
2. Check that the Healthy LED lights up. Check that watchdog changes status. The default screen is displayed (phase and neutral voltage VN measurement of V).

Easergy P1V Identification

Record the Easergy P1V serial number (found on the identification label on the top of the relay or menu cell **OP PARAMETERS/Serial number**) on the test sheet.

Record the Easergy P1V software version number (menu cell **OP PARAMETERS/Firmware Version** and **Firmware Release**) on the test sheet.

Validation of the Complete Protection Chain

Principle

The complete protection chain is validated during the simulation of a fault that causes tripping of the circuit breaker by Easergy P1V.

Simply testing one function indicates that the whole system is working correctly, provided it has been installed correctly.

Procedure

To validate the complete protection chain, proceed as follows:

Step	Description
1	Select one of the protection functions that trips the circuit breaker.
2	Depending on the function(s) selected, inject a voltage corresponding to a fault and note whether the circuit breaker trips.
3	If the switchgear is equipped in terminal blocks put the covers back on the test terminal blocks.

Checking Settings

Determining Parameter and Protection Settings

All the Easergy P1V parameter and protection settings are determined beforehand by the design department in charge of the application and should be approved by the customer.

It is presumed that the study has been carried out with all the attention necessary, or even consolidated by a discrimination study.

All the Easergy P1V parameter and protection settings should be available for commissioning in the form of a dossier.

Checking Parameter and Protection Settings

Checks should be made when the Easergy P1V parameter and protection settings have not been entered during commissioning tests, to confirm the conformity of the parameter and protection settings entered with the values determined during the study.

These checks consist of:

- Going through all the Easergy P1V parameter and protection setting cells
- For each menu cell, comparing the values entered in the Easergy P1V relay with the values recorded in the parameter and protection settings file
- Correcting any parameter and protection settings that have not been entered correctly.

NOTE: Once the checks are complete, as of that phase, the parameter and protection settings should not be changed any further and are considered to be final.

The tests which follow must be performed with these parameter and protection settings. It will not be possible to modify any values, even temporarily. The only exception to this is the disabling of protection functions in order to isolate the protection function being tested.

Checking the VT Ratio

Purpose of the Check

In the context of checking the complete protection chain, checking each VT helps to ensure that its transformation ratio conforms to expectations and is identical for the 2 or 3 phase VTs.

Purpose

The VT conformity certificates can be used as a basis for the check. If these documents are missing, proceed as follows:

Step	Action
1	Check that the VT primary circuit is accessible, de-energized and completely isolated.
2	Using documents (diagrams, etc.), determine the expected ratio and check the corresponding Easergy P1V setting.
3	Make sure that the VT secondary is connected to the Easergy P1V relay and install (parallel) a voltmeter on the secondary circuit of the first VT.
4	Connect the generator to the VT primary circuit.
5	Inject a voltage of at least 20% of VT primary rated voltage if possible and measure the injected value.
6	Read the voltage measured in the secondary circuit by the voltmeter and check that the transformation ratio conforms to expectations. If the VT is connected to Easergy P1V, check that the voltage displayed by Easergy P1V is the same as the voltage injected in the VT primary.
7	Repeat steps 3 to 6 for the other phase VT(s) and check that the results obtained are identical for both or all 3 VTs.
8	If the neutral voltage is measured from open delta, inject voltage to one phase and check that measured by voltmeter or displayed by Easergy P1V value is correct.
9	Record your measurements on the test sheet.

Checking the Phase Voltage Input Connections

Applicable to Easergy P1V Series

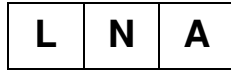

Wiring Diagram

To inject a voltage into the phase A voltage input, connect the single-phase voltage generator to the test terminal block, as shown in the diagram below.

Figure 12. Phase voltages input connections diagram

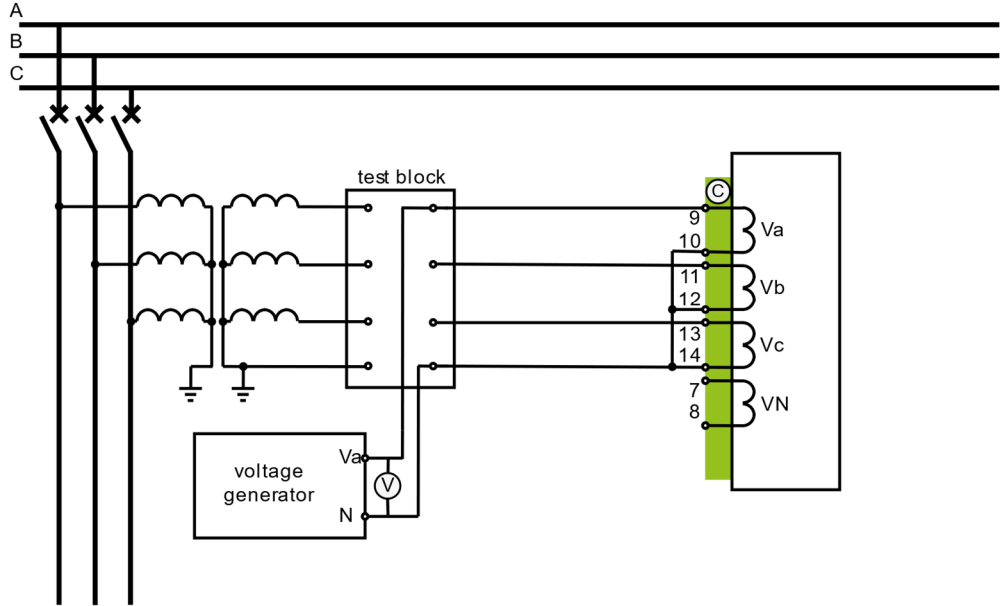

Procedure

NOTICE

RISK OF EQUIPMENT DAMAGE

- Using a multi-meter/voltmeter, measure the voltage transformer secondary voltages to ensure they are compliant with the Easergy P1 protection relay’s input ratings.
- Check that the system phase rotation is correct using a phase rotation meter.

Failure to follow these instructions can result in equipment damage.

⚠ DANGER

HAZARD OF ELECTRIC SHOCK, ELECTRIC ARC OR BURNS

- Wear insulating gloves to avoid any contact with a conductor that has accidentally been energized.

Failure to follow these instructions will result in death or serious injury.

Step	Action
1	Connect the voltage generator to inject a voltage into a phase voltage input.
2	Turn on the generator.
3	Inject the VT secondary rated voltage (57.74 V/63.51 V).

4	On the P1V display, check that the value of the phase A voltage is approximately equal to the VT primary rated voltage or related to V_n (depends on setting).
5	Turn off the generator.
6	Repeat steps 1 to 5 for the other two phase voltage inputs.
7	Replace the cover on the test terminal block.

Checking the Neutral Voltage Input Connections

Applicable to Easergy P1V Series

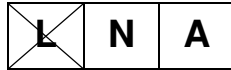

Wiring Diagram

Connect the single-phase voltage generator to the test terminal block, as shown in the diagram below:

Figure 13. Neutral voltage input – open delta connections diagrams

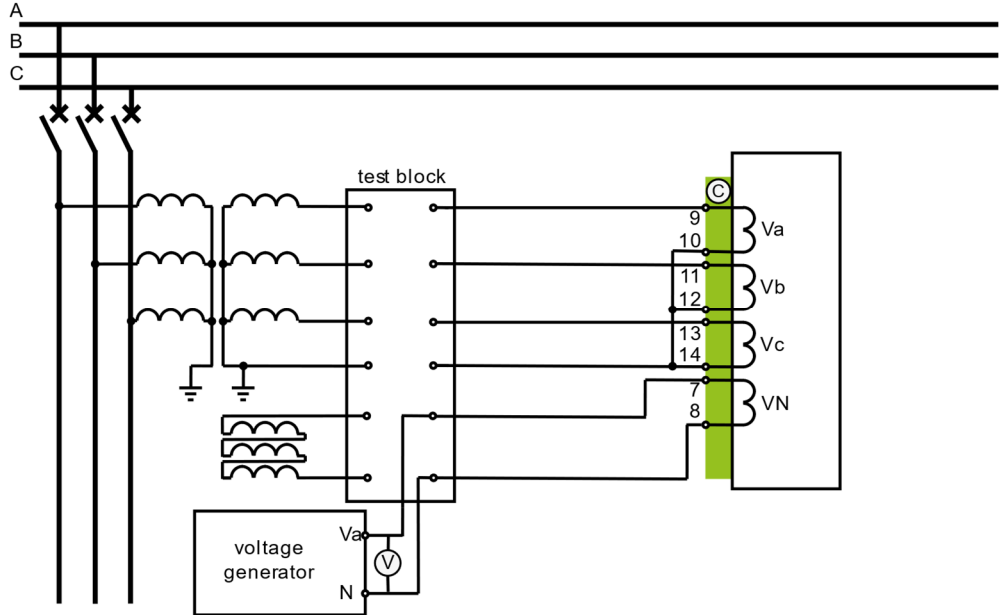

Neutral Voltage (open delta) Input Check Procedure

Step	Action
1	Turn on the generator.
2	Inject the VT secondary rated voltage (57.74 V/63.51 V).
3	Check on the P1V display that the earth fault voltage value is approximately equal to 57.74 V/63.51 V.
4	Turn off the generator.
5	Replace the cover on the test terminal block.

Overvoltage Protection (ANSI 59) Test

Applicable to Easergy P1V Series

L	N	A
---	---	---

Purpose of the Test

The phase overvoltage protection test is used to check the setting values for the following protection functions:

- Tripping threshold
- Tripping time delay

Wiring Diagram

To inject voltage into the phase A voltage input, connect the single-phase voltage generator as shown in the diagram below.

Use one of the P1V output relays to stop the chronometer. If you are using a circuit breaker contact to stop the chronometer, the measured time includes the circuit breaker operating time.

Figure 14. Connection diagram to overvoltage protection function tests

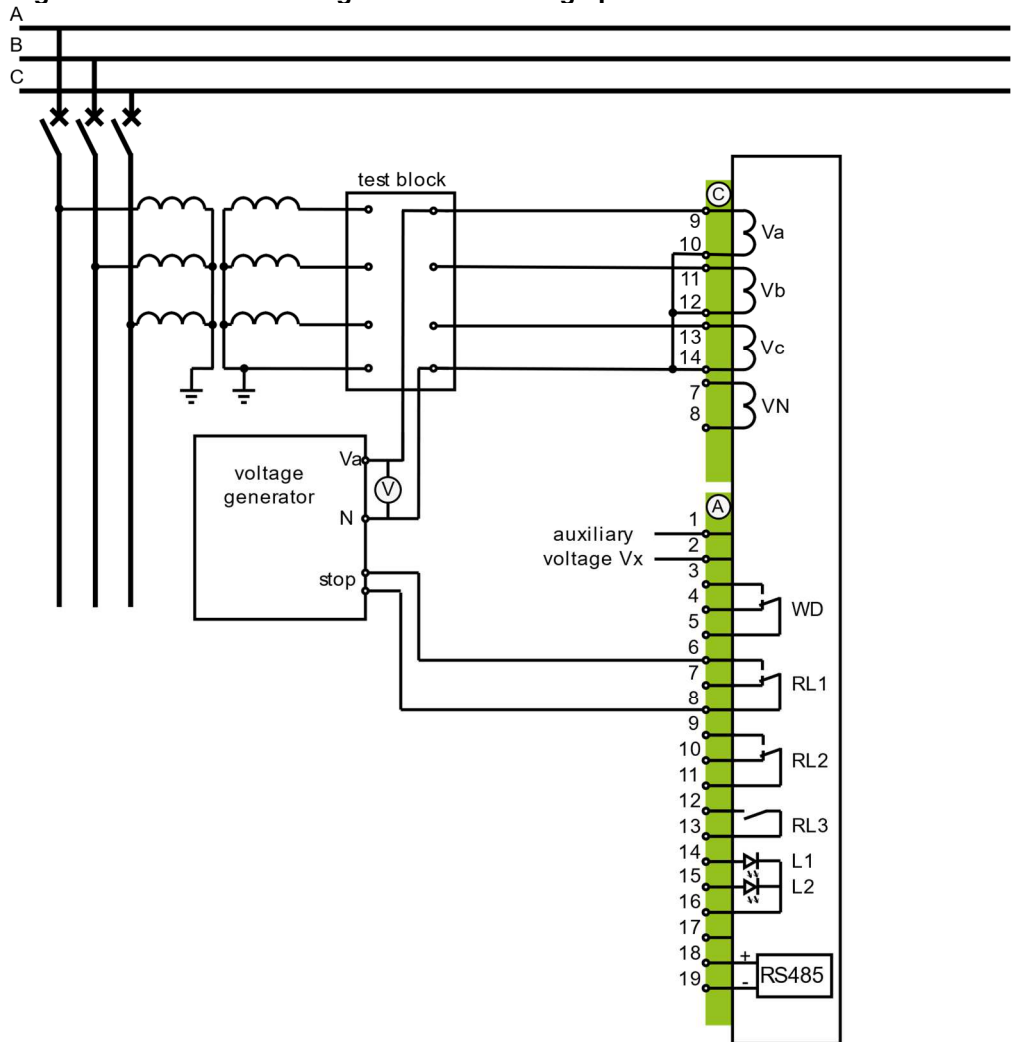

Definite Time Protection Test

⚠ DANGER

HAZARD OF ELECTRIC SHOCK, ELECTRIC ARC OR BURNS

- Wear insulating gloves to avoid any contact with a conductor that has accidentally been energized.
- Disconnect secondary circuit of voltage transformer winding by use test block without disconnecting the wires from it.

Failure to follow these instructions will result in death or serious injury.

A definite time protection function uses two settings that are independent of one another:

- The voltage set point (V>, V>> or V>>>)
- The time delay

Two checks are therefore required

Threshold check:

Step	Action
1	If necessary disable: <ul style="list-style-type: none"> • undervoltage protection function the earth fault protections (if they are based on the vector sum of the 3 phase $(\vec{V}_a + \vec{V}_b + \vec{V}_c)$). • negative sequence overvoltage protection function (N, A). • positive sequence undervoltage protection function (A). • over-/under- frequency protection function (A).
2	Inject a voltage approximately equal to 80% of the threshold value.
3	Increase the voltage slowly until the P1V relay trips or until the overvoltage protection (signals: tV>, tV>>, tV>>>) LED flashes quickly (if are assigned).
4	Record the voltage value at the time of tripping on the test sheet and compare it with the value on the settings sheet.
5	Reset P1V (R key).
6	If you are not performing any other checks: <ul style="list-style-type: none"> • Re-enable the protections and functions required by the settings sheet. • When a blocking input is used, re-enable the back-up time delay associated with each threshold.

Time delay check:

Step	Action
1	If necessary disable: <ul style="list-style-type: none"> • undervoltage protection function the earth fault protections (if they are based on the vector sum of the 3 phase $(\vec{V}_a + \vec{V}_b + \vec{V}_c)$). • negative sequence overvoltage protection function (N, A). • positive sequence undervoltage protection function (A). • over-/under- frequency protection function (A).
2	Prepare to inject a voltage at least twice as high as the tripping voltage measured in the threshold check.
3	Re-establish the injection circuit in the P1V relay and set the chronometer to zero.
4	Start voltage injection and the chronometer simultaneously and use the voltmeter to make sure the injected voltage is stable. When P1V trips, the chronometer stops.
5	Record the time elapsed on the test sheet and compare it with the value on the settings sheet.
6	Reset Easergy device (R key).

7	<p>If you are not performing any other checks:</p> <ul style="list-style-type: none"> • Re-enable the protections and functions required by the settings sheet. • When a blocking input is used, re-enable the back-up time delay associated with each threshold.
---	---

IDMT Protection Test

IDMT protection uses a standardized curve (V, t).

The test consists of testing a few points on the curve, in the tripping zone for the threshold V>.

Checking a point on the curve:

Step	Action
1	<p>If necessary disable:</p> <ul style="list-style-type: none"> • undervoltage protection function <p>the earth fault protections (if they are based on the vector sum of the 3 phase ($\vec{V}_a + \vec{V}_b + \vec{V}_c$)).</p> <ul style="list-style-type: none"> • negative sequence overvoltage protection function (N, A). • positive sequence undervoltage protection function (A). • over-/under- frequency protection function (A).
2	<p>Choose a point (V/V>, t) to be tested in the threshold tripping zone, using the <i>Overvoltage Protection Tripping Curves, page 105 and subsequent ones</i>.</p>
3	<p>Set the generator for the voltage determined in step 2.</p>
4	<p>Reset the chronometer to zero and reset P1V if necessary (R key).</p>
5	<p>Start voltage injection and the chronometer simultaneously and use the voltmeter to make sure the injected voltage is stable. When P1V trips, the chronometer stops.</p>
6	<p>Record the time elapsed on the test sheet and compare it with the expected value.</p>
7	<p>Reset Easergy device (R key).</p>
8	<p>If you are not performing any other checks:</p> <ul style="list-style-type: none"> • Re-enable the protections and functions required by the settings sheet. • When a blocking input is used, re-enable the back-up time delay associated with each threshold.

Neutral Voltage Displacement Protection (ANSI 59N) Test

Applicable to Easergy P1V Series

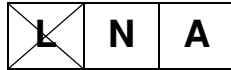

Purpose of the Test

The neutral voltage displacement protection test is used to check the setting values for the following protection functions:

- Tripping threshold
- Tripping time delay

Neutral voltage is being measured using an open delta connection.

Wiring Diagram with open delta circuit

To inject voltage into the neutral voltage input, connect the single-phase voltage generator as shown in the diagram below.

Use one of the P1V output relays to stop the chronometer. If you are using a circuit breaker contact to stop the chronometer, the measured time includes the circuit breaker operating time.

Figure 15. Connection diagram to neutral voltage displacement protection function tests

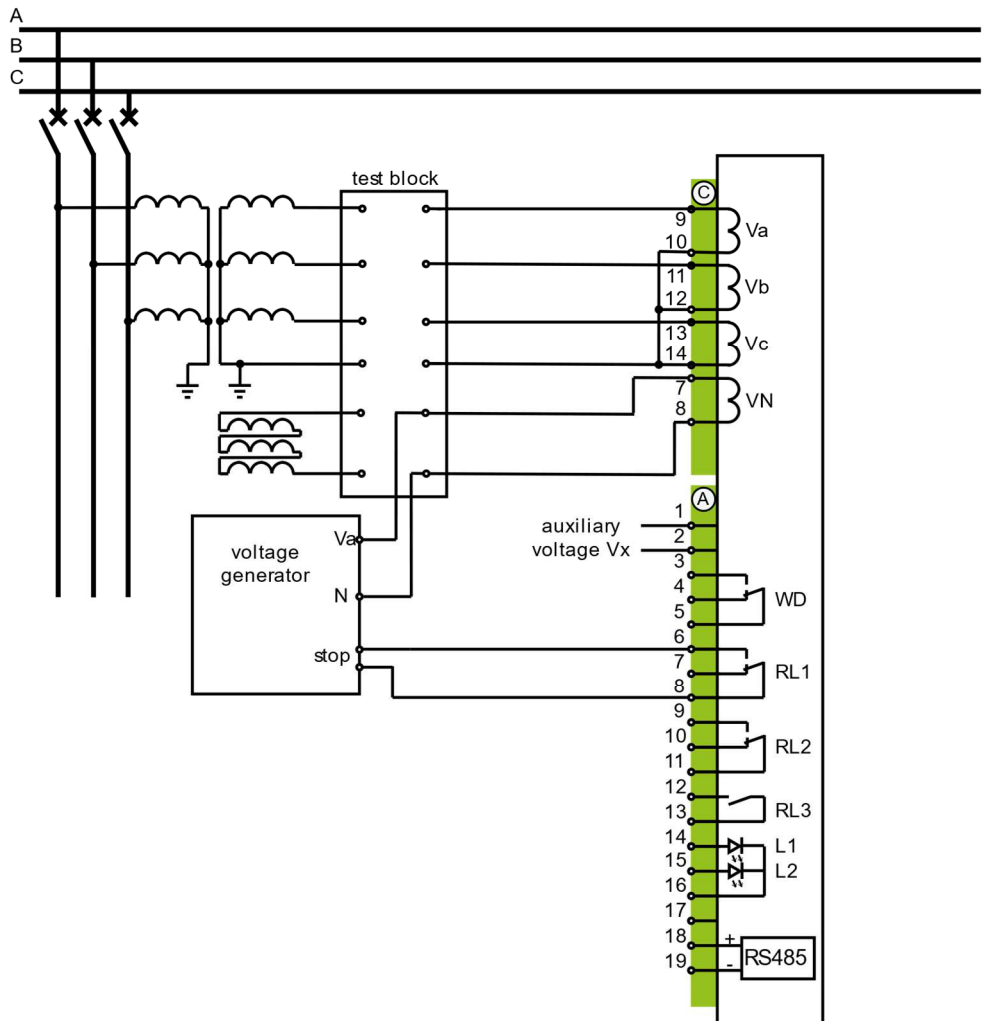

Definite Time Protection Test

A definite time protection function uses two settings that are independent of one another:

- The voltage set point (VN>, VN>> or VN>>>)
- The time delay

Two checks are therefore required

Threshold check:

Step	Action
1	If necessary disable: <ul style="list-style-type: none"> • undervoltage protection function • overvoltage protection function • negative sequence overvoltage protection function (N, A). • positive sequence undervoltage protection function (A). • over-/under- frequency protection function (A).
2	Inject a voltage approximately equal to 80% of the threshold value.
3	Increase the voltage slowly until the P1V relay trips or until the overvoltage protection (signals: tVN>, tVN>>, tVN>>>) LED flashes quickly (if assigned).
4	Record the voltage value at the time of tripping on the test sheet and compare it with the value on the settings sheet.
5	Reset P1V (R key).
6	If you are not performing any other checks: <ul style="list-style-type: none"> • Re-enable the protections and functions required by the settings sheet. • When a blocking input is used, re-enable the back-up time delay associated with each threshold.

Time delay check:

Step	Action
1	If necessary disable: <ul style="list-style-type: none"> • undervoltage protection function • overvoltage protection function • negative sequence overvoltage protection function (N, A). • positive sequence undervoltage protection function (A). • over-/under- frequency protection function (A).
2	Prepare to inject a voltage at least twice as high as the tripping voltage measured in the threshold check.
3	Re-establish the injection circuit in the P1V relay and set the chronometer to zero.
4	Start voltage injection and the chronometer simultaneously and use the voltmeter to make sure the injected voltage is stable. When P1V trips, the chronometer stops.
5	Record the time elapsed on the test sheet and compare it with the value on the settings sheet.
6	Reset P1V (R key).
7	If you are not performing any other checks: <ul style="list-style-type: none"> • Re-enable the protections and functions required by the settings sheet. • When a blocking input is used, re-enable the back-up time delay associated with each threshold.

IDMT Protection Test

IDMT protection uses a standardized curve (VN, t).

The test consists of testing a few points on the curve, in the tripping zone for the threshold VN>.

Checking a point on the curve:

Step	Action
1	If necessary disable: <ul style="list-style-type: none"> • undervoltage protection function • overvoltage protection function • negative sequence overvoltage protection function (N, A). • positive sequence undervoltage protection function (A). • over-/under- frequency protection function (A).
2	Choose a point ($VN/VN>$, t) to be tested in the threshold tripping zone, using the <i>Overvoltage Protection Tripping Curves, page 105 and subsequent</i> .
3	Set the generator for the voltage determined in step 2.
4	Reset the chronometer to zero and reset P1V if necessary (R key).
5	Start voltage injection and the chronometer simultaneously and use the voltmeter to make sure the injected voltage is stable. When P1V trips, the chronometer stops.
6	Record the time elapsed on the test sheet and compare it with the expected value.
7	Reset P1V (R key).
8	If you are not performing any other checks: <ul style="list-style-type: none"> • Re-enable the protections and functions required by the settings sheet. • When a blocking input is used, re-enable the back-up time delay associated with each threshold.

Checking the Logic Input Connections

Applicable to Easergy P1V Series

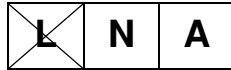

Checking the Logic Inputs

To check the logic inputs, proceed as follows for each input.

Step	Action
1	Display the <i>I/P Status</i> menu cell in the relay menu.
2	<ul style="list-style-type: none"> • If the input power supply voltage is available, use an electric cord to short-circuit the contact that delivers logic data to the input. • If the input power supply voltage is not available, apply a voltage supplied by the DC voltage generator to the terminal of the contact linked to the chosen input. To adjust the voltage level: refer to <i>Connecting the Logic Inputs, page 31</i>.
3	Note any change in the display.
4	If necessary, reset the P1V (R key).

Operational Commissioning

Final Check

When the tests are complete, proceed as follows for the final check:

Step	Action
1	Put the cover back on the test block
2	Look through all the screens relating to the Easergy P1V protection functions and check that only the desired protections are active.
3	Check the conformity of the validated parameters in Easergy P1V against the settings sheet.
4	Record the last event recorded by Easergy P1V on the test sheet so that you can distinguish between the values attributable to the tests and those due to subsequent activation of the protections by a fault on the installation. The Easergy P1V relay is now operational.

Easergy P1V Test Sheet

Use

This test sheet can be used to record the results of the commissioning tests. Each test is described in detail in the Commissioning chapter. Only carry out the tests required, depending on the Easergy type and the functions in use.
Check the box when the check has been made and is conclusive.

Identification

Workstation		Test Conducted on:	By:
Cubicle		Comments	
Type of Easergy P1			
Serial Number			
Software version			
(to be read in the EASERGY screen in the parameters menu)			

Overall Checks

Type of Check	
Preliminary inspection, prior to energization	<input type="checkbox"/>
Energization	<input type="checkbox"/>
Checking parameters and settings	<input type="checkbox"/>
Connecting the logic inputs (Easergy P1V, model N, A)	<input type="checkbox"/>
Validation of the Complete Protection Chain	<input type="checkbox"/>

Checking the VT Ratio

VT Checked	Theoretical Transformation Ratio	Primary Injection Voltage	Voltage Measured at the Secondary	Measured Transformation Ratio	
Phase VT A					<input type="checkbox"/>
Phase VT B					<input type="checkbox"/>
Phase VT C					<input type="checkbox"/>
Neutral VN					<input type="checkbox"/>

Checking the Voltage Inputs

Type of Check	Test Performed	Result	Display	
Connecting the phase voltage inputs	Secondary injection of the VT rated voltage, either 100 V or 110 V.	VT primary rated voltage	Va = Vb = Vc =	<input type="checkbox"/>
Connecting the neutral voltage input	Secondary injection of the VT rated voltage 100 V	Injected voltage value	VN =	<input type="checkbox"/>

Overvoltage Protection (ANSI 59) Tests

V> set point with definite time curve

Voltage Set Point Test <input type="checkbox"/>		Time Delay Test <input type="checkbox"/>	
Set point set	Set point measured	Time delay set	Time delay measured

V> set point with IDMT curve

	Injected Voltage Measured	Tripping Time		
		Theoretical	Measured	
Point 1				<input type="checkbox"/>
Point 2				<input type="checkbox"/>
				<input type="checkbox"/>
				<input type="checkbox"/>

V>> set point with definite time curve

Voltage Set Point Test <input type="checkbox"/>		Time Delay Test <input type="checkbox"/>	
Set point set	Set point measured	Time delay set	Time delay measured

V>> set point with IDMT curve

	Injected Voltage Measured	Tripping Time		
		Theoretical	Measured	
Point 1				<input type="checkbox"/>
Point 2				<input type="checkbox"/>
				<input type="checkbox"/>
				<input type="checkbox"/>

V>>> set point with definite time curve

Voltage Set Point Test <input type="checkbox"/>		Time Delay Test <input type="checkbox"/>	
Set point set	Set point measured	Time delay set	Time delay measured

Neutral Voltage Protection (ANSI 50N/51N) Tests

VN> set point with definite time curve

Voltage Set Point Test <input type="checkbox"/>		Time Delay Test <input type="checkbox"/>	
Set point set	Set point measured	Time delay set	Time delay measured

VN> set point with IDMT curve

	Injected Voltage Measured	Tripping Time		
		Theoretical	Measured	
Point 1				<input type="checkbox"/>
Point 2				<input type="checkbox"/>
				<input type="checkbox"/>
				<input type="checkbox"/>

VN>> set point with definite time curve

Voltage Set Point Test <input type="checkbox"/>		Time Delay Test <input type="checkbox"/>	
Set point set	Set point measured	Time delay set	Time delay measured

VN>>> set point with definite time curve

Voltage Set Point Test <input type="checkbox"/>		Time Delay Test <input type="checkbox"/>	
Set point set	Set point measured	Time delay set	Time delay measured

Undervoltage Protection (ANSI 59) Tests

V< set point with definite time curve

Voltage Set Point Test <input type="checkbox"/>		Time Delay Test <input type="checkbox"/>	
Set point set	Set point measured	Time delay set	Time delay measured

V< set point with IDMT curve

	Injected Voltage Measured	Tripping Time		
		Theoretical	Measured	
Point 1				<input type="checkbox"/>
Point 2				<input type="checkbox"/>
				<input type="checkbox"/>
				<input type="checkbox"/>

V<< set point with definite time curve

Voltage Set Point Test <input type="checkbox"/>		Time Delay Test <input type="checkbox"/>	
Set point set	Set point measured	Time delay set	Time delay measured

V<<< set point with definite time curve

Voltage Set Point Test <input type="checkbox"/>		Time Delay Test <input type="checkbox"/>	
Set point set	Set point measured	Time delay set	Time delay measured

Negative Sequence Overvoltage Protection (ANSI 47) Tests

V2> set point with definite time curve

Voltage Set Point Test <input type="checkbox"/>		Time Delay Test <input type="checkbox"/>	
Set point set	Set point measured	Time delay set	Time delay measured

V2> set point with IDMT curve

	Injected Voltage Measured	Tripping Time		
		Theoretical	Measured	
Point 1				<input type="checkbox"/>
Point 2				<input type="checkbox"/>
				<input type="checkbox"/>
				<input type="checkbox"/>

V2>> set point with definite time curve

Voltage Set Point Test <input type="checkbox"/>		Time Delay Test <input type="checkbox"/>	
Set point set	Set point measured	Time delay set	Time delay measured

Positive Sequence Undervoltage Protection (ANSI 27D) Tests

V1 < set point with definite time curve

Voltage Set Point Test <input type="checkbox"/>		Time Delay Test <input type="checkbox"/>	
Set point set	Set point measured	Time delay set	Time delay measured

V1 < set point with IDMT curve

	Injected Voltage Measured	Tripping Time		
		Theoretical	Measured	
Point 1				<input type="checkbox"/>
Point 2				<input type="checkbox"/>
				<input type="checkbox"/>
				<input type="checkbox"/>

V1 << set point with definite time curve

Voltage Set Point Test <input type="checkbox"/>		Time Delay Test <input type="checkbox"/>	
Set point set	Set point measured	Time delay set	Time delay measured

Over/Under Frequency Protection (ANSI 81O/81U) Tests

f1 set point with definite time curve

Overfrequency <input type="checkbox"/>		Underfrequency <input type="checkbox"/>	
Frequency Set Point Test <input type="checkbox"/>		Time Delay Test <input type="checkbox"/>	
Set point set	Set point measured	Time delay set	Time delay measured

f2 set point with definite time curve

Overfrequency <input type="checkbox"/>		Underfrequency <input type="checkbox"/>	
Frequency Set Point Test <input type="checkbox"/>		Time Delay Test <input type="checkbox"/>	
Set point set	Set point measured	Time delay set	Time delay measured

f3 set point with definite time curve

Overfrequency <input type="checkbox"/>		Underfrequency <input type="checkbox"/>	
Frequency Set Point Test <input type="checkbox"/>		Time Delay Test <input type="checkbox"/>	
Set point set	Set point measured	Time delay set	Time delay measured

f4 set point with definite time curve

Overfrequency <input type="checkbox"/>		Underfrequency <input type="checkbox"/>	
Frequency Set Point Test <input type="checkbox"/>		Time Delay Test <input type="checkbox"/>	
Set point set	Set point measured	Time delay set	Time delay measured

f5 set point with definite time curve

Overfrequency <input type="checkbox"/>		Underfrequency <input type="checkbox"/>	
Frequency Set Point Test <input type="checkbox"/>		Time Delay Test <input type="checkbox"/>	
Set point set	Set point measured	Time delay set	Time delay measured

f6 set point with definite time curve

Overfrequency <input type="checkbox"/>		Underfrequency <input type="checkbox"/>	
Frequency Set Point Test <input type="checkbox"/>		Time Delay Test <input type="checkbox"/>	
Set point set	Set point measured	Time delay set	Time delay measured

External Trip (Auxiliary Timers) Tests

AUX1 with definite time curve

Time Delay Test <input type="checkbox"/>	
Time delay set	Time delay measured

AUX2 with definite time curve

Time Delay Test <input type="checkbox"/>	
Time delay set	Time delay measured

AUX3 with definite time curve

Time Delay Test <input type="checkbox"/>	
Time delay set	Time delay measured

Binary Inputs Tests

Binary Inputs	Working
L1	<input type="checkbox"/>
L2	<input type="checkbox"/>
L3	<input type="checkbox"/>
L4	<input type="checkbox"/>
L5	<input type="checkbox"/>
L6	<input type="checkbox"/>

Relay Outputs Tests

Relay Outputs	Working
RL1	<input type="checkbox"/>
RL2	<input type="checkbox"/>
RL3	<input type="checkbox"/>
RL4	<input type="checkbox"/>
RL5	<input type="checkbox"/>
RL6	<input type="checkbox"/>
RL7	<input type="checkbox"/>
WD	<input type="checkbox"/>

LEDs Tests

Relay Outputs	Working
LED 1 Trip	<input type="checkbox"/>
LED 2 Alarm	<input type="checkbox"/>
LED 3	<input type="checkbox"/>
LED 4	<input type="checkbox"/>
LED 5	<input type="checkbox"/>

LED 6	<input type="checkbox"/>
LED 7	<input type="checkbox"/>
LED 8 Healthy	<input type="checkbox"/>

Use

Human Machine Interface

Front Panel

The Human Machine Interface (HMI) on the front panel of P1V relays consists of a display, LEDs, keys and front local communication port (mini USB).

A sealable pivoting flap can help to prevent access to the setting keys by unauthorized persons (optional equipment).

Figure 16. Front panel of the relay:

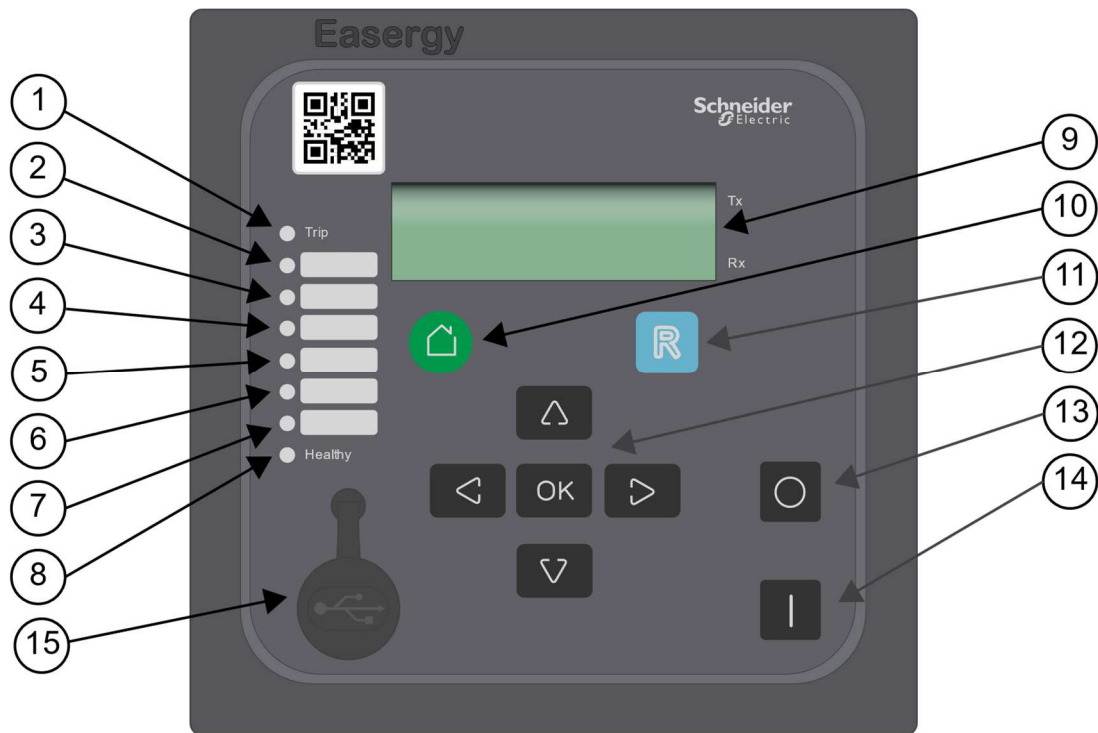

- 1 – Red “Trip” LED
- 2, 3, 4, 5, 6, 7, – Freely programmable LED (second LED is yellow, rest of them red)
- 8 – Green “Healthy” LED (Watchdog)
- 9 – Display (graphic liquid crystal display - LCD)
- 10 – Home key
- 11 – Reset/Clear key
- 12 – 4 arrow keys, and confirm entry OK key
- 13 – CB Open key
- 14 – CB Close key
- 15 – Mini-USB type B port for local connectionsUSB

Healthy LED Status

Healthy LED status	Function
Green LED On	P1V on
Green LED Flashing	P1V in the fail-safe position

Display

The display is a backlit LCD unit.

Each P1V protection function is presented in a screen consisting of the following items:

- First line: Protection function name
- Second line: Displays protection function status or set values of parameters associated with the function
- Third line:
 - <0.10 40.00> setting range:
 - ┌┐0.01 step values of parameters associated with the function
- Fourth line: The following special symbols may appear:
 - ▲ possible to move up by pressing the ▲ key.
 - ◀ possible to move left by pressing the ◀ key.
 - ▼ possible to move down by pressing the ▼ key.
 - ▶ possible to move right by pressing the ▶ key.
 - ↶ the last menu cell in the column. If the ▼ key is pressed here the cursor will reach the first cell in the column.
 - ✎ possible to edit the displayed values. A menu pointer, on the left: it points to the pictogram for the selected menu.
 - 🔒 Edition of values on the display password-protected.
 - 🔓 Edition of setting value is possible (the level correct password has been entered).
 - 1 On the last line: Setting group 1 is displayed.
In the bottom right corner: Setting group 1 is active.
 - 2 On the last line: Setting group 2 is displayed.
In the bottom right corner: Setting group 2 is active.
 - USB USB communication port is active. When communication port is disabled then USB pictogram is not displayed.

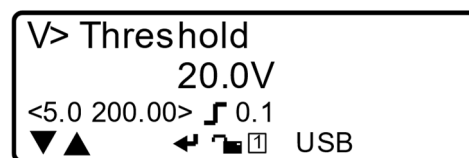

Menu organization

The menu content depends on the Easergy P1V model. The list of screens by menu, for each model, is given at the end of this chapter – Menu Map. Menu in Easergy P1V has got pulldown structure.

Default Display

A default screen is displayed automatically 10 minutes after the last keystroke. This default screen is (depends on settings **GLOBAL SETTINGS/LOC/Default Display**):

- The screen displaying the three phase to phase voltages and neutral voltage in volts
- The screen displaying the three phase to phase voltages and neutral voltage per unit (in reference to Vn or Ven)
- The screen displaying the three phase to neutral voltages and neutral voltage in volts
- The screen displaying the three phase to neutral voltages and neutral voltage per unit (in reference to Vn or Ven)
- The screen displaying CB status and possibility to CB control

- The screen displaying control mode status and possibility to change the control mode

Operation

Access to Data

During operation, the user can access the following data:

- Readout of measurements, parameters and protection settings
- Local annunciation of the last fault:
 - by a light up LED associated with a fault
 - by a fault screen on the display unit
- Acknowledgement of the last fault
- Readout of the 20 last recorded faults
- Readout of the 5 last recorded alarms
- Readout of the 5 last recorded triggers
- Readout counters:
 - control counters
 - fault counter
 - CB monitoring counter
- Reset of latched LEDs and relay outputs (if the causes disappeared)
- LED test

Readout of Measurements, Parameters and Protection Settings

When the P1V operate, the user can read all the data contained in the relay.

Announcement of the Last Fault

When a fault is detected by P1V, it may be indicated locally by:

- A fault LED (Trip and any other freely configurable LEDs, depending on configuration), which lights up for as long as the fault is present and has not been acknowledged
- A fault screen, which is displayed on the display unit and remains displayed until the operator presses a key

The operator can acknowledge faults locally by pressing the Reset key.

P1V relays connected to a communication network:

- Indicate faults remotely-indication bit
- Can receive an order to acknowledge faults from the communication



Fault and LEDs Signals

The fault and signals LEDs light up to indicate a fault or any other signals assigned to LEDs (depending on configuration).

Trip and Healthy LEDs are fixed, the rest of LEDs are freely configurable. LEDs can be latched or not. If latching of LED is disabled, the LED goes out once the cause disappeared.

Fault Screens (Fault Record)

Fault screens (column) inform the operator about the characteristics of the last fault detected by the P1V relay.

The operator can consult the other cells using the  or  keys. If the relay is reset the operator can still consult the 20 last recorded faults in the **FAULT RECORDS** menu (column).

Menu Cell	Description
<div style="border: 1px solid black; padding: 5px;"> Fault Type Trip tV> ▼▲ </div>	Fault origin Protection function that caused the trip
<div style="border: 1px solid black; padding: 5px;"> Fault Time 00:24:01.760 ▼▲ </div>	Time of the fault
<div style="border: 1px solid black; padding: 5px;"> Fault Date 01/01/15 ▼▲ </div>	Date of the fault
<div style="border: 1px solid black; padding: 5px;"> Active Setting Group 1 ▼▲ </div>	Which setting group was active at the time of the fault
<div style="border: 1px solid black; padding: 5px;"> Fault Origin Phases A-C ▼▲ </div>	Phase fault origin
<div style="border: 1px solid black; padding: 5px;"> Va= 40.1V Vb= 0.0V ▼▲ </div>	Value of the voltages in phase A and B measured at the time of the fault
<div style="border: 1px solid black; padding: 5px;"> Vc= 40.1V VN= 0.0V ▼▲ </div>	Value of the voltages in phase C and neutral measured at the time of the fault

Fault Acknowledgement

Pressing the Reset key acknowledges faults locally and causes:

- The latched output relays to be reset
- The fault LED to go out

After acknowledgement, the P1V relay displays the default display (set in **GLOBAL SETTINGS/LOC/Default Display**).

Readout of the 20 Last Recorded Faults

Each P1V relays record the characteristics of the 20 last faults.

These records can be accessed in the **RECORDS/FAULT RECORDS** menu. Selection of fault number is possible in below cell (first cell in **FAULT RECORDS** column):

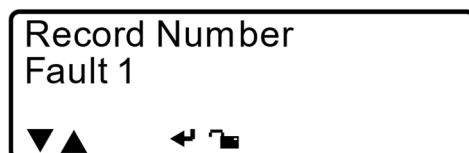

Readout of the 5 Last Recorded Alarms

Each P1V relays record the characteristics of the 5 last alarms.

These records can be accessed in the **RECORDS/ALARM RECORD** menu.

Selection of alarm number is possible in below cell (first cell in **ALARM RECORD** column):

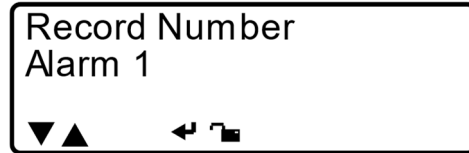

Readout Counters

P1V relays models **N, A** count the following values:

- CONTROL COUNTERS
 - Trip numbers
 - Close numbers
- FAULT COUNTER
 - Fault Trips number
 - Fault Starts number
 - Alarms number
 - Hardware Warnings number

Each above counter can be reset in below cell (in the end of each counter column)



Reset of Latched LEDs and Relay Outputs

Reset of latched LEDs and relay outputs is possible if the causes disappeared.

Reset can be done by:

- Use reset key
- Assigned binary inputs
- From Scada system (depends on select control mode)

LED Test

The LED test is used to check that each LED on the front panel are working correctly.

To perform the test (when any protections are not triggered), press C button from default display cell level. After this, all LEDs on the front panel light up for approx. 1s.

Settings

Access to Parameters and Settings

These parameters and settings are divided into the following menus:

- The protection menu (**SETTING GROUP x**), which contains the essential settings for setting up the protection functions
- The parameters menu (**GLOBAL SETTINGS**), which contains the parameters that can be used to adapt Easergy P1V operation to particular applications

Access the Settings with a Password









By default, modification of the Easergy P1V protection and parameter settings are accessed by a password. Refer to *Password*, page 128





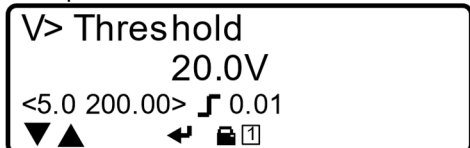
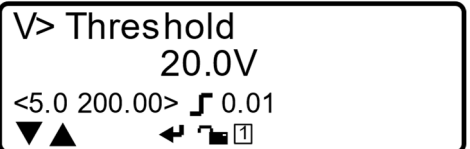
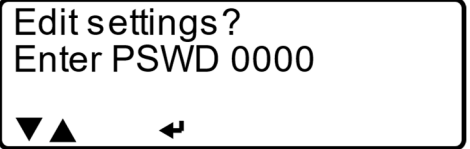

In this mode (passworded device), P1V will ask automatically about the password if the **OK** key is pressed in any editable menu cell during a setting operation (edit mode). The password is a 4-digit number. Depends on the level (**Configurator**, **Operator**, **User**) passwords are different.

Once the correct code has been entered, modification of the settings is allowed for 10 minutes after the last keystroke. When the user wants to exit from edit mode faster then one can select **Edit settings?** cell from menu (**SETTING CHANGE MODE** column) and press **OK** key.

Setting a Parameter

















The procedure for setting a protection function or a parameter is as follows:

Step	Action
1	<p>Select the menu cell for the function to be set using the , ,  or  keys.</p> <p>Example:</p> 
2	<p>Press the OK key:</p> <ul style="list-style-type: none"> • If password protection is not active, the function parameter flashes - the parameter is selected and can be set (edition is possible – edit mode, padlock is open):  <ul style="list-style-type: none"> • Otherwise, the password entry menu cell is displayed:  <p>and refer to the <i>Entering the Password</i> section.</p>
3	<p>Use the , ,  and  keys to scroll through the parameter values until the desired value is displayed.</p>
4	<p>To confirm the new parameter value, press the OK key: the set parameter value is displayed (not flashing) to indicate that it has been considered by P1V only after exit from setting mode.</p>

Step	Action
	To abort the voltage parameter entry, back to step 2 and set again previous value or set.
5	If the set parameter is completely set, then you can select a new settings (menu cells) using the  ,  ,  and  keys and set as described in step 3.
6	If all required P1V protection and parameter settings are completely set then to confirm all new settings it is necessary exit from setting mode. To exit from setting mode select Edit settings? cell from menu (SETTING CHANGE MODE column): <div data-bbox="584 521 1051 674" style="border: 1px solid black; padding: 5px; margin: 10px 0;"> Edit settings? Exit: Press OK    </div> and press OK key.

Setting a Relay Outputs

The procedure for assigning a relay outputs is as follows:











Step	Action
1	Using the  ,  ,  or  keys to select in SETTING GROUP x/ OUTPUT RELAYS CONFIGURATION Gx signal or signals which to be assigned to the outputs. Example (A) <div data-bbox="584 1043 1051 1196" style="border: 1px solid black; padding: 5px; margin: 10px 0;"> Protect. 7654321 Trip 0000000      </div> Digits in first row (7654321) means number of relay outputs: 7 – RL 7 6 – RL 6 5 – RL 5 4 – RL 4 3 – RL 3 2 – RL 2 1 – RL 1 Digits in second row (0000000) means that the signal is assigned to definite relay output or outputs. The high state of the function mapped to the output determines the high state of the output relay. The low state of this function does not change the state of the output relay.
2	Press the OK key: <ul style="list-style-type: none"> If password protection is not active, the first digits on the right side in second row flashes (edition is possible – edit mode): <div data-bbox="584 1753 1051 1906" style="border: 1px solid black; padding: 5px; margin: 10px 0;"> Protect. 7654321 Trip 0000000      </div> Otherwise, the password entry menu cell is displayed: <div data-bbox="584 1944 1051 2096" style="border: 1px solid black; padding: 5px; margin: 10px 0;"> Edit settings? Enter PSWD 0000    </div>

Step	Action
	and refer to the <i>Entering the Password</i> section.
3	Using the , , or keys select output or outputs to assigned definite signal. Digit 0 (in second row) under the relay output number means that signal is not assigned to output. Digit 1 (in second row) under the relay output number means that selected signal is assigned to selected output (for example to RL 1 and RL 4): <div style="border: 1px solid black; padding: 5px; margin: 10px 0;"> Protect 7654321 Trip 0001001 </div>
4	Press the OK key to confirm the new settings for relay outputs: the set parameter value is displayed (not flashing) to indicate that it has been considered by P1V only after exit from setting mode.
5	If the relay outputs is completely set, then you can select a new signals using the and keys and set as described in step 2 and 3.
6	If all required P1V relay outputs are completely set then to confirm all new settings it is necessary exit from setting mode (refer section <i>Setting a Parameter</i>).

Setting a Binary Input

















The procedure for assigning a binary input is as follows:







Step	Action
1	Using the , , or keys to select in SETTING GROUP x/ INPUTS CONFIGURATION Gx signal or signals which to be assigned to the binary inputs. Example (A) <div style="border: 1px solid black; padding: 5px; margin: 10px 0;"> Status 654321 CB 52A 000000 </div> Digits in first row (654321) means number of binary inputs: 6 – BI 6 5 – BI 5 4 – BI 4 3 – BI 3 2 – BI 2 1 – BI 1 Digits in second row (000000) means that the signal is assigned to definite relay input or inputs – 1, or not assigned – 0 .
2	Press the OK key: <ul style="list-style-type: none"> If password protection is not active, the first digits on the right side in second row flashes (edition is possible – edit mode): <div style="border: 1px solid black; padding: 5px; margin: 10px 0;"> Status 654321 CB 52A 000000 </div> Otherwise, the password entry menu cell is displayed: <div style="border: 1px solid black; padding: 5px; margin: 10px 0;"> Edit settings? Enter PSWD 0000 </div> and refer to the <i>Entering the Password</i> section.

Step	Action
3	<p>Using the , ,  or  keys select input or inputs to assigned definite signal. Digit 0 (in second row) under the binary input number means that signal is not assigned to input. Digit 1 (in second row) under the binary input number means that selected signal is assigned to selected input (for example to BI 2 and BI 6):</p> <div style="border: 1px solid black; padding: 5px; width: fit-content; margin: 10px auto;"> <p>Status 654321 CB 52A 100010</p> <p>    </p> </div>
4	<p>Press the OK key to confirm the new settings for binary inputs: the set parameter value is displayed (not flashing) to indicate that it has been considered by P1V only after exiting from setting mode.</p>
5	<p>If the binary inputs is completely set, then you can select a new signals using the , and  keys and set as described in step 2 and 3.</p>
6	<p>If all required P1V binary inputs are completely set then to confirm all new settings it is necessary exit from setting mode (refer section <u>Setting a Parameter</u>).</p>

Setting a LED Indicators

The procedure for assigning a LED indicator is as follows:

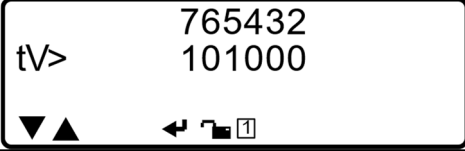



Step	Action
1	<p>Using the , ,  or  keys to select in SETTING GROUP x/ LEDS CONFIGURATION Gx signal or signals which to be assigned to the LED indicators.</p> <p>Example:</p> <div style="border: 1px solid black; padding: 5px; width: fit-content; margin: 10px auto;"> <p>tV> 765432 000000</p> <p>    </p> </div> <p>Digits in first row (765432) means number of LED indicators: 7 – LED 7 6 – LED 6 5 – LED 5 4 – LED 4 3 – LED 3 2 – LED 2</p> <p>Digits in second row (000000) means that the signal is assigned to definite LED indicator or indicators – 1, or not assigned – 0.</p>
2	<p>Press the OK key:</p> <ul style="list-style-type: none"> If password protection is not active, the first digits on the right side in second row flashes (edition is possible – edit mode): <div style="border: 1px solid black; padding: 5px; width: fit-content; margin: 10px auto;"> <p>tV> 765432 000000</p> <p>    </p> </div> <ul style="list-style-type: none"> Otherwise, the password entry menu cell is displayed: <div style="border: 1px solid black; padding: 5px; width: fit-content; margin: 10px auto;"> <p>Edit settings? Enter PSWD 0000</p> <p>  </p> </div>

Step	Action
	and refer to the <i>Entering the Password</i> section.
3	Using the  ,  ,  or  keys select LED or LEDs to assigned definite signal. Digit 0 (in second row) under the LED indicator number means that signal is not assigned to this LED. Digit 1 (in second row) under the LED indicator number means that selected signal is assigned to selected LED (for example to LED 5 and LED 7): 
4	Press the OK key to confirm the new settings for LED indicators: the set parameter value is displayed (not flashing) to indicate that it has been considered by P1V only after exit from setting mode.
5	If the LED indicator is completely set, then you can select a new signal using the  and  keys and set as described in step 2 and 3.
6	If all required P1V LED indicators are completely set then to confirm all new settings it is necessary exit from setting mode (refer section <i>Setting a Parameter</i>).

NOTE: Trip LED is fixed.

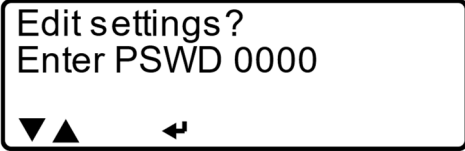
Entering a Password to Authorize a Setting

The 4 password digits must be entered common. The procedure for entering the password is as follows:

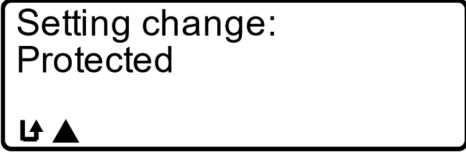
Step	Action
1	The password entry screen is displayed and the first from the right digit (0) flashes: 
2	Use the  ,  ,  and  keys to scroll through the digits from 0 to 9 and select correct password.
3	Once the password has been entered: <ul style="list-style-type: none"> • If the password is correct: the voltage setting menu cell is displayed again. It is then possible to modify the protection and parameter settings. • If the password is incorrect: the message Protected is displayed and this means that no protection and parameter settings can be change. 

Lost Password

If you lost the password, read the serial number on the Easergy P1V label and contact your local Schneider Electric after-sales service.

Password Protection

More details are described in Password subchapter in Function and Parameters chapter (see on page 128).

USB Communication Port

Introduction

Mini-USB type B front port is dedicated to local connection with eSetup Easergy Pro setting and operating software tool for configuring Easergy P1 devices. By default, port is disabled.

NOTICE

USB communication port is dedicated to set the relay; extract settings, event, disturbance recorder files. USB port is not dedicated to energizing the device.

Operation

It is possible to enable a USB communication port from the local panel of Easergy P1 protection relay only. To enable USB communication port qualified personnel must be logged in to the relay from the *Configurator* level. To modification of USB communication port parameters is not required approved of all settings – exit from edit mode (warm restart). When USB communication is active then on LCD is displayed following pictogram:



When communication on USB line/port is not active for 60 minutes, the USB port is automatically disabled and USB pictogram on LCD disappears.

It is not possible to enable USB communication port by rear RS485 communication port.

Setting

Settings for the COMMUNICATION USB port can be found in **GLOBAL SETTINGS/COMMUNICATION USB** menu:

Available Setting	Authorized Values	Default Setting
Enable USB Port	0: Disable 1: Enable	Disable
Protocol	0: Modbus S1 1: IEC-103 2: Modbus Std 3: GetSet	Modbus S1
Baud Rate	0: 4800 1: 9600 2: 19200 3: 38400 4: 57600 5: 115200 6: 187500	115200
Parity	0: No parity 1: Odd parity 2: Even parity	No parity
Stop Bits	0: 1 stop bit 1: 2 stop bits	1 stop bit

GetSet protocol is dedicated to communication Easergy P1 with eSetup Easergy Pro. Recommended USB parameters to communication with eSetup Easergy Pro are presented in below:

Setting	Recommended Setting
Enable USB Port	Enable
Protocol	GetSet
Baud Rate	115200
Parity	No parity
Stop Bits	1 stop bit

RS485 Communication Port

Introduction

RS485 rear port is dedicated to connection with SCADA system. By default port is disabled.

It is possible to enable a communication port from the local panel of Easergy P1 protection relay or from eSetup Easergy Pro with the CONFIGURATOR access right (COMMUNICATION/Communication RS485 – see below).

Figure 17. eSetup Easergy Pro Communication RS485 window

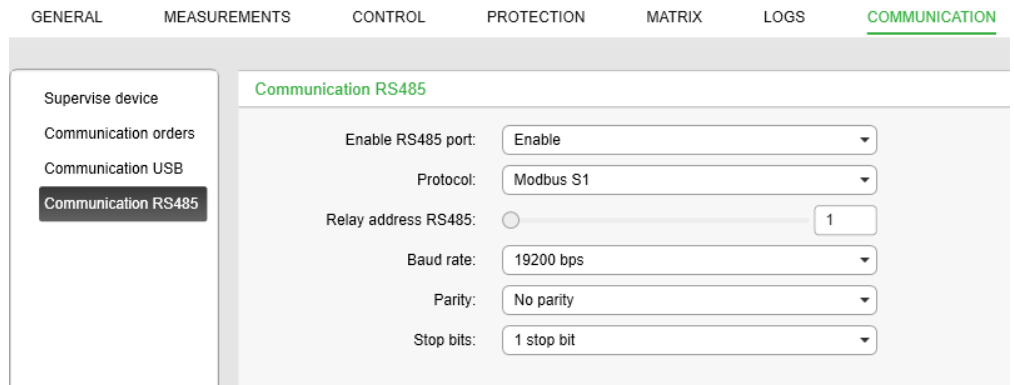

Setting

Settings for the COMMUNICATION USB port can be found in **GLOBAL SETTINGS/COMMUNICATION RS485** menu:

Available Setting	Authorized Values	Default Setting
Enable USB Port	0: Disable 1: Enable	Disable
Protocol	0: Modbus S1 1: IEC-103 2: Modbus Std 3: GetSet	Modbus S1
Relay Address RS485	1-247 (Step 1)	247
Baud Rate	0: 4800 1: 9600 2: 19200 3: 38400 4: 57600 5: 115200	115200
Parity	0: No parity 1: Odd parity 2: Even parity	No parity
Stop Bits	0: 1 stop bit 1: 2 stop bits	1 stop bit

First Steps with eSetup Easergy Pro

Overview

eSetup Easergy Pro is a setting and operating software tool for configuring Easergy P1 devices, local operation and customization functions. The eSetup Easergy Pro software is supplied directly through the Schneider - Electric website www.schneider-electric.com, along with the eSetup Easergy Pro program for recovering disturbance recording files, and all the Easergy P1 documentation in PDF format.

Figure 18. eSetup Easergy Pro menu bar and tool bar

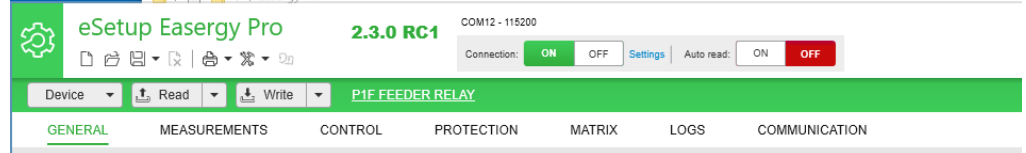

The eSetup Easergy Pro software has a graphical interface where the protection relay settings and parameters are grouped under nine menu tabs:

- General
- Measurements
- Control
- Protection
- Matrix
- Logs
- Communication

The contents of the tabs depend on the device type and the selected application mode. Refer to the User Manual of eSetup Easergy Pro for detailed information on the setting views of each menu.

The eSetup Easergy Pro stores the device configuration in a setting file. The configuration of one physical device is saved in one setting file. The configurations can be printed out and saved for later use.

When starting to work with eSetup Easergy Pro, you have three options:

- Create a new setting file without connecting to a protection relay
- Open an existing (previously saved) setting file without connecting to a protection relay
- Connect to a relay and read the settings from the protection relay.

eSetup Easergy Pro can be connected to a single relay via the USB port in the protection relays front panel or via RS485 in the protection relays rear port.

Operation Modes

The eSetup Easergy Pro software can be used in three operation modes:

- Disconnected mode
- Single unit connecting mode
- Network connecting mode

Using eSetup Easergy Pro in disconnected mode

The disconnected mode allows you to prepare parameters and settings files for Easergy P1 prior to commissioning.

The parameter and protection setting files prepared in disconnected mode will be downloaded later to the Easergy P1 protection relays in connected mode.

In Disconnected mode, the user can create a setting file from scratch, or open a previously saved setting file as a basis for creating configuration for a protection relay of the same type. Refer to the User Manual of eSetup Easergy Pro for more information.

Using eSetup Easergy Pro connected to a single Easergy P1

The single connection mode is used during commissioning of an Easergy P1 protection relay:

- To upload, download or modify Easergy P1 parameters and settings.

Refer to the User Manual of eSetup Easergy Pro for more information on uploading (writing)/downloading (reading) setting files to/from the connected protection relays.

NOTICE

After writing new settings, configurations or firmware to a protection relay, perform a test to verify that the protection relay operates correctly with the new settings.

Failure to follow these instructions can result in unwanted shutdown of the electrical installation.

- To have all the measurements and supporting data available for commissioning.

The PC fitted with the eSetup Easergy Pro software is connected to the USB port on the front panel of the Easergy P1 using a USB cord.

Cable Type: USB 2.0:

- Connectors:
 - PC: type A male
 - P1V: type mini B 5-pin male
- USB Cable: minimum 1P*28AWG/2C*24AWG, max: 2m

Figure 19. Connecting a PC to the Easergy P1 using a USB cable

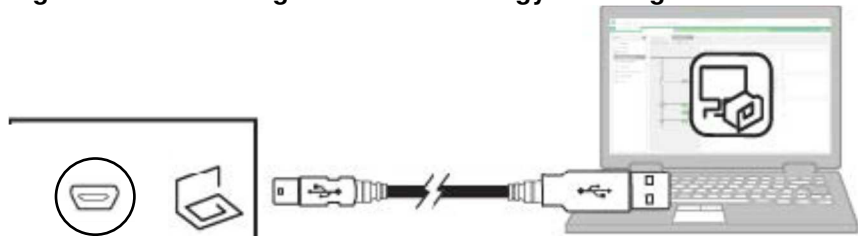

Using eSetup Easergy Pro connected to an Easergy P1 network

The network connection mode is used during operation:

- To manage the protection system.
- To check the status of the power supply.
- To diagnose any incident occurring on the power supply.

The PC fitted with the eSetup Easergy Pro software is connected to a group of Easergy P1 units via a communication network (connection via serial link).

The connection window allows configuration of the Easergy P1 network, and provides access to the parameter and protection setting files of the Easergy P1 units on the network.

Connecting to a single protection relay using USB cable

1. Install the USB driver from the eSetup Easergy Pro file package (location: Drivers/P3 – for the Easergy P1 is the same driver as Easergy P3) for the first time connecting the Easergy P1 protection relay to a PC running eSetup Easergy Pro
2. Connect the USB cable between the PC running eSetup Easergy Pro and the local port of the Easergy P1 protection relay, with the mini-USB type B connector of the cable plugged into the protection relay and the type A connector to the PC.
3. On the eSetup Easergy Pro toolbar, click the ON connection button. The Login pop-up window opens.

Figure 20. The connection buttons on the tool bar



4. Select the right USB serial port and connection speed.

Figure 21. Connect window in the eSetup Easergy Pro

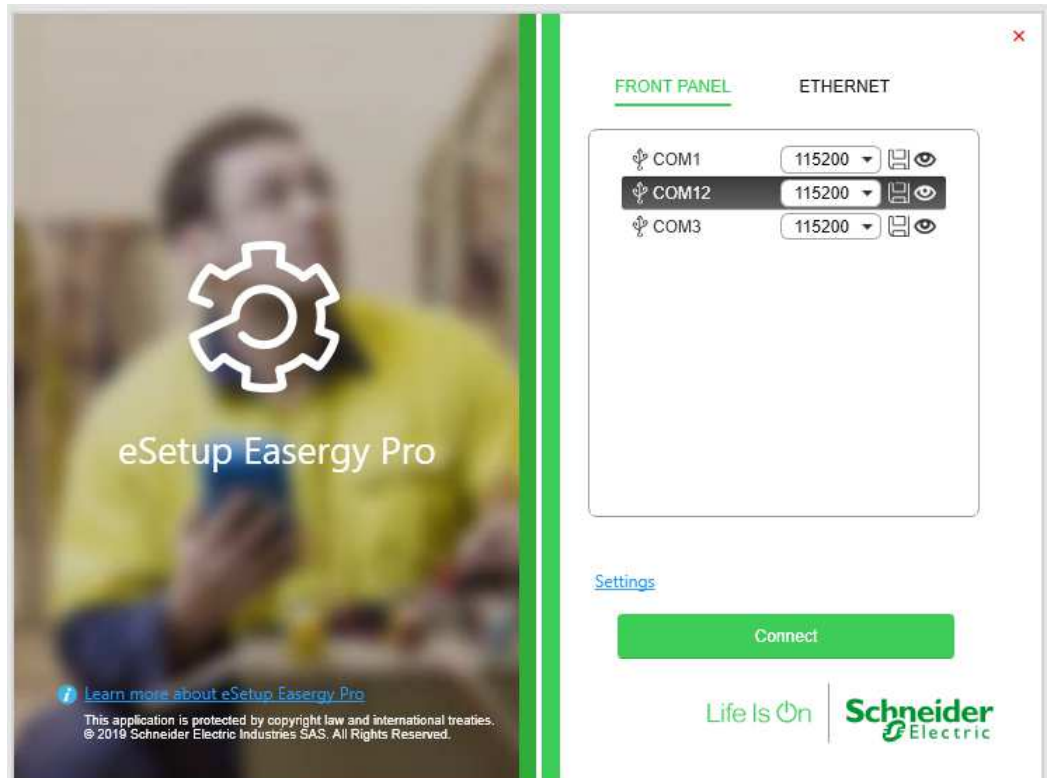

5. Click Connect.
A new window showing the relay information opens.

Figure 22. Window of access level selection in the eSetup Easergy Pro

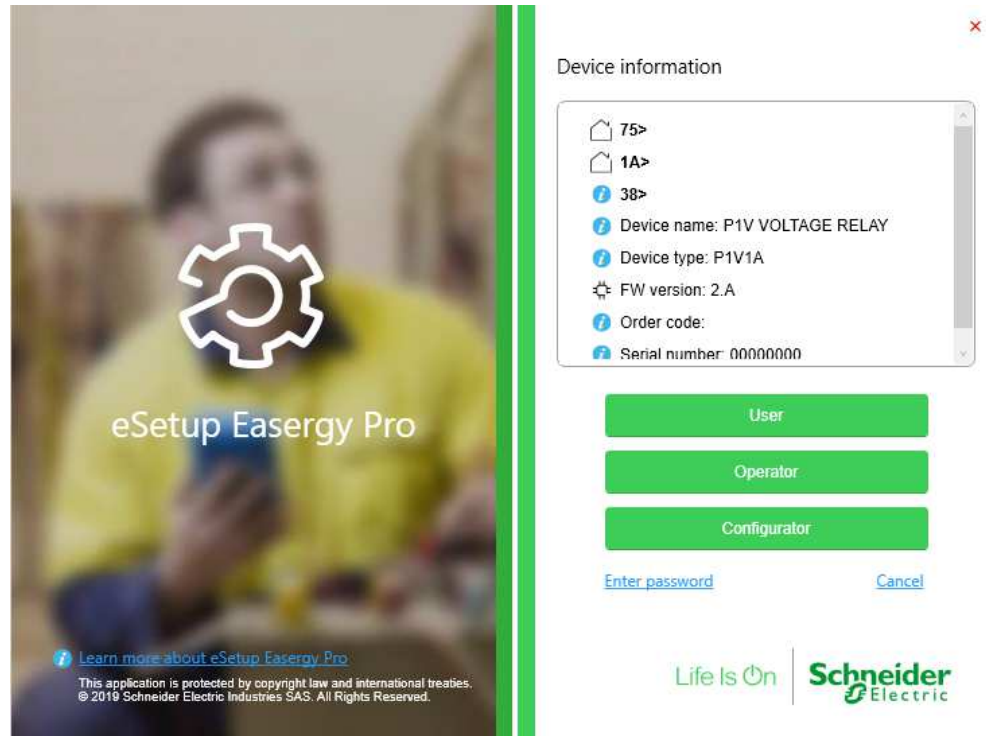

6. Enter the user name and password to login.

Figure 23. Main menu window in the eSetup Easergy Pro

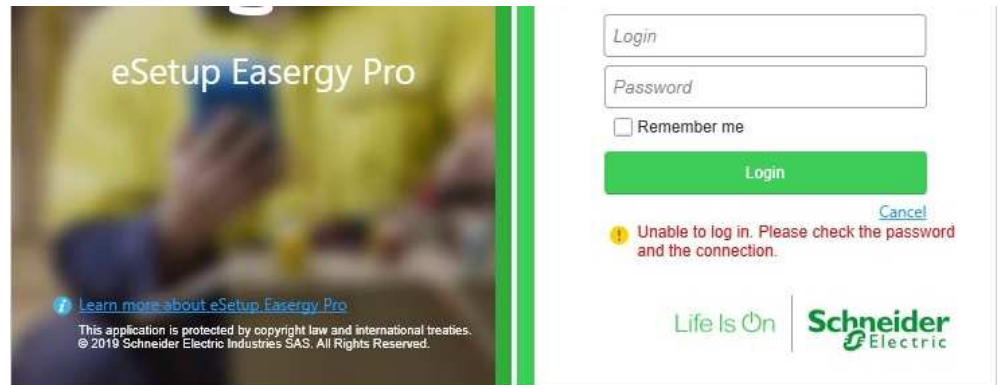

Name of the login for each levels are given in below table.

Level	Login
Configurator	conf
Operator	oper
User	user

7. eSetup Easergy Pro's main view opens.

Figure 24. Main menu window in the eSetup Easergy Pro

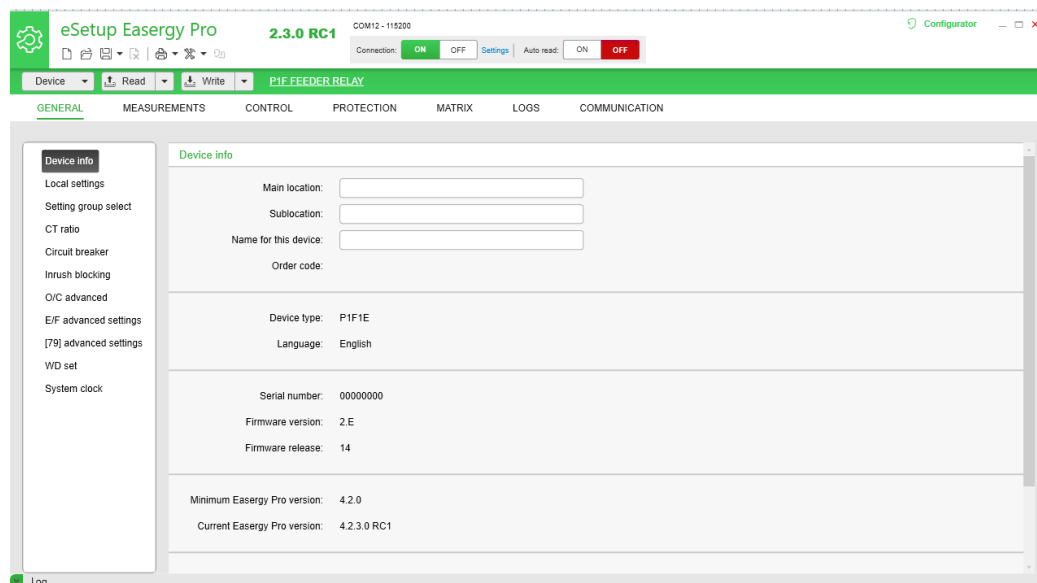

NOTE: If you connect for the first time to a device on which the default users and passwords are used, see [Password subchapter in Function and Parameters chapter](#), page 128.

Menu Map

The menu content depends on the Easergy P1V model. Binary inputs and relay outputs menu cells content maximum number of binary inputs and relay outputs which are different depends on the model. For example, for model A in relay outputs menu cells is displayed 7 relay outputs (maximum), and for model L 3 relay outputs only.

	Binary inputs	Relay Outputs
Model L	0	3+WD
Model N	2	5+WD
Model A	6	7+WD

Figure 25. Menu map main menu

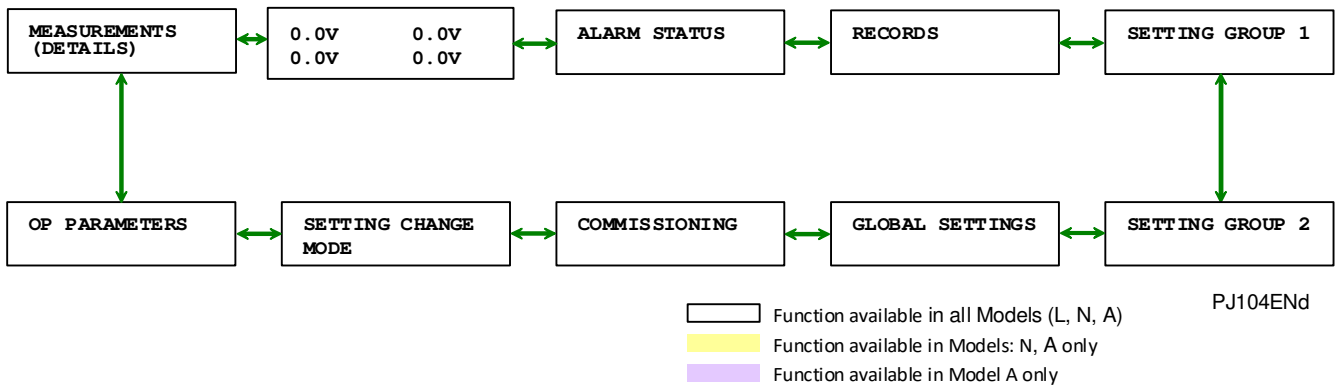

Figure 26. Menu map submenu part 1

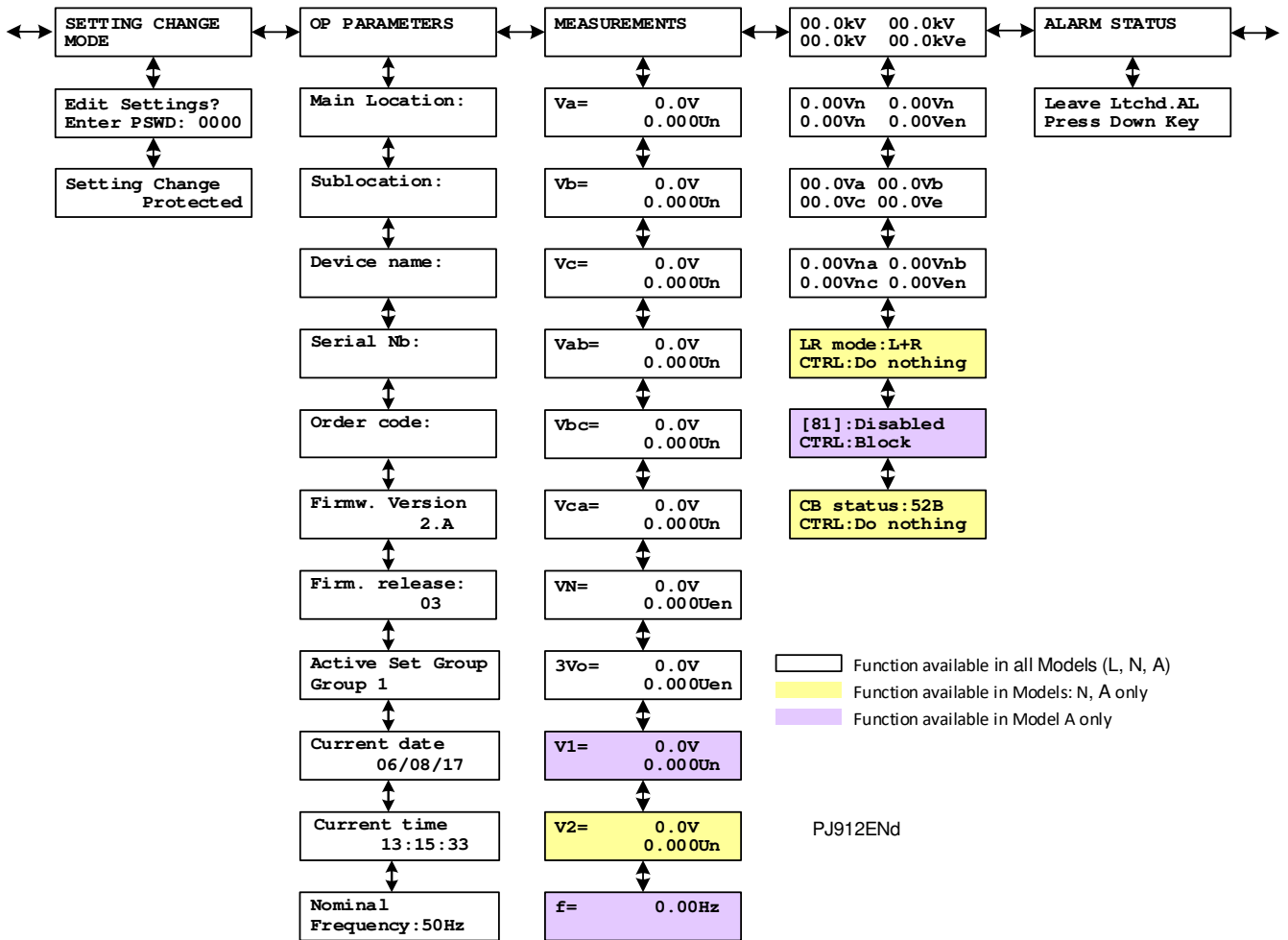
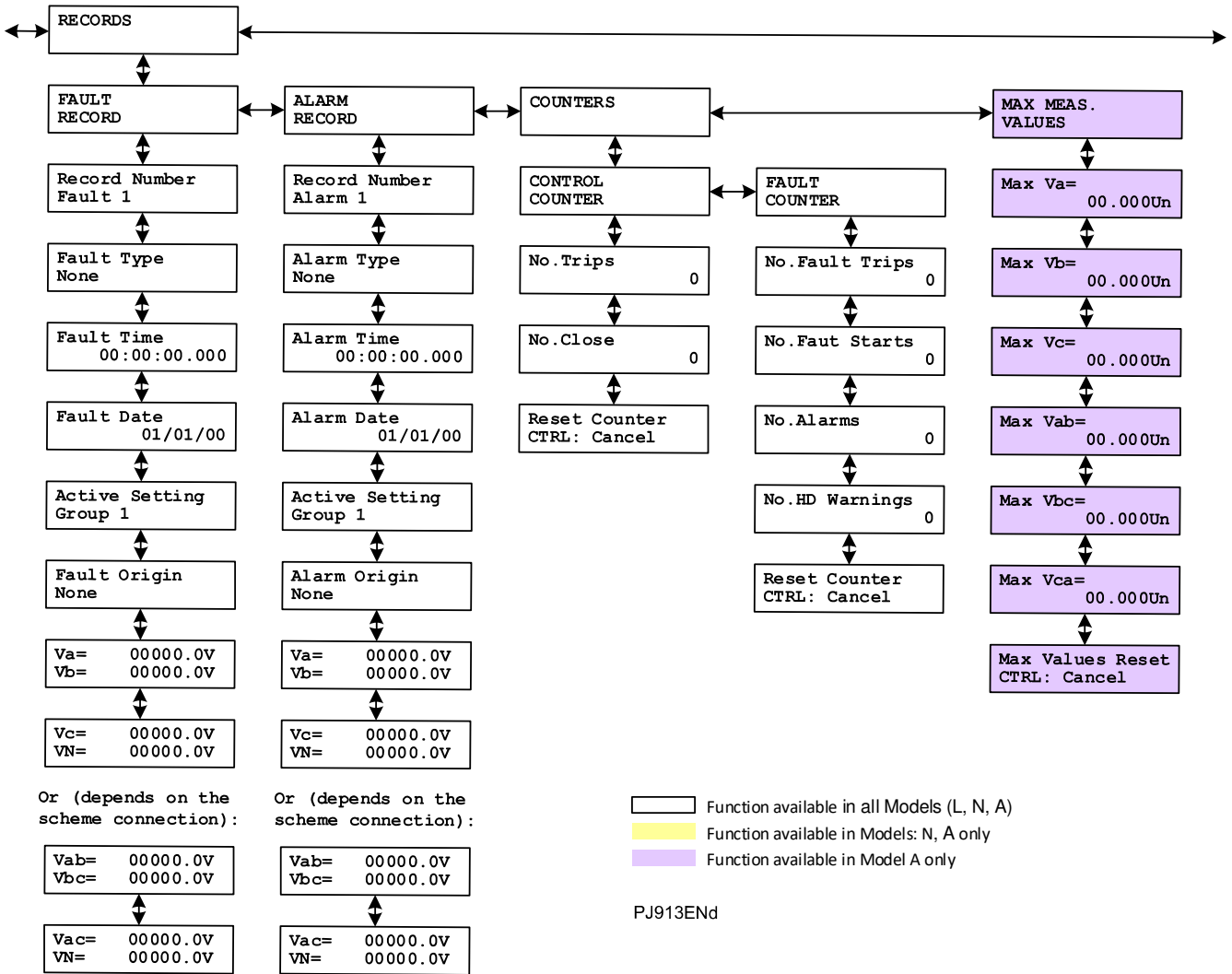

Figure 27. Menu map submenu part 2



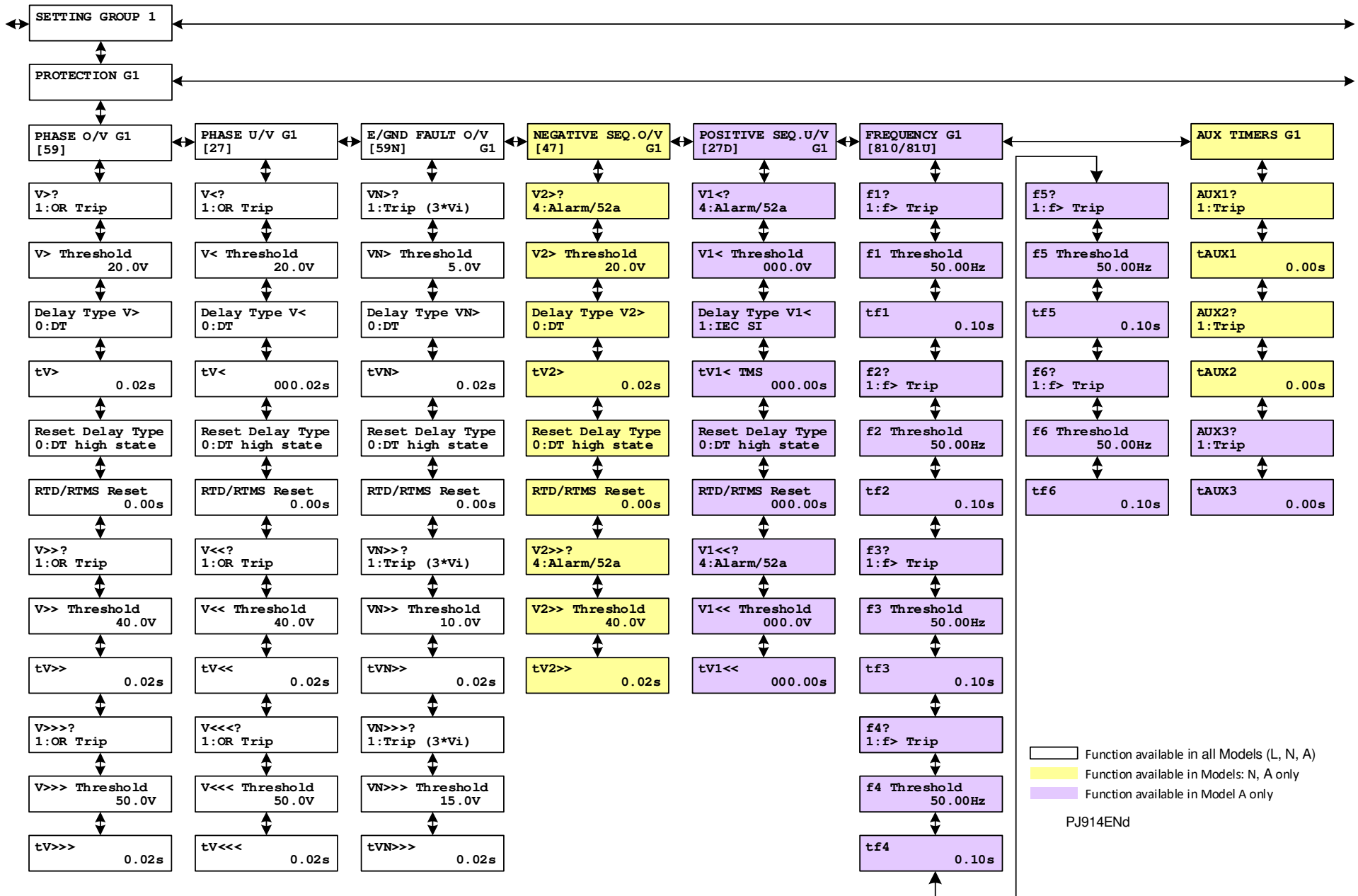
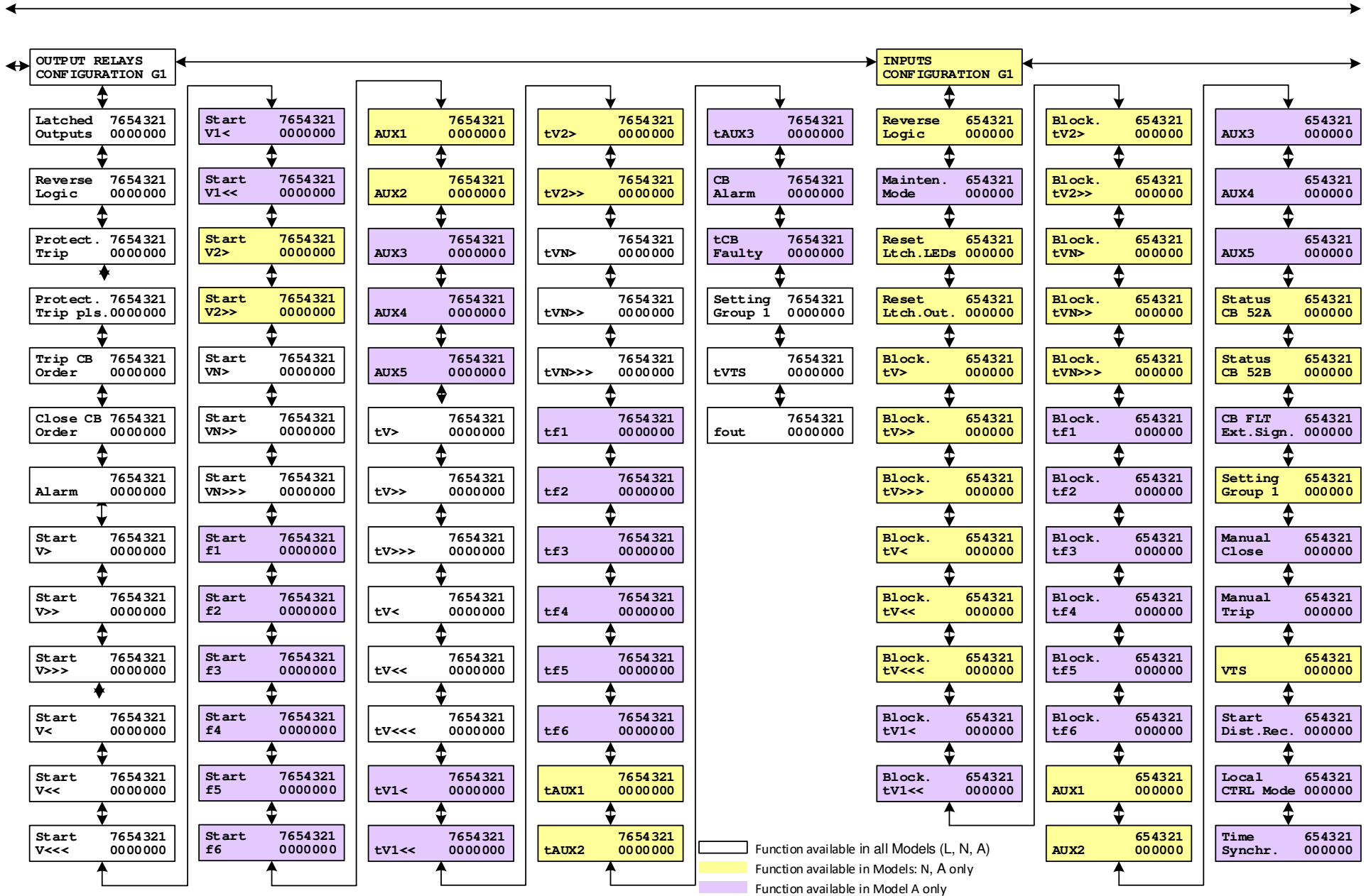

Figure 28. Menu map submenu part 3



Function available in all Models (L, N, A)
 Function available in Models: N, A only
 Function available in Model A only

PJ915END

Figure 29. Menu map submenu part 4

Figure 30. Menu map submenu part 5

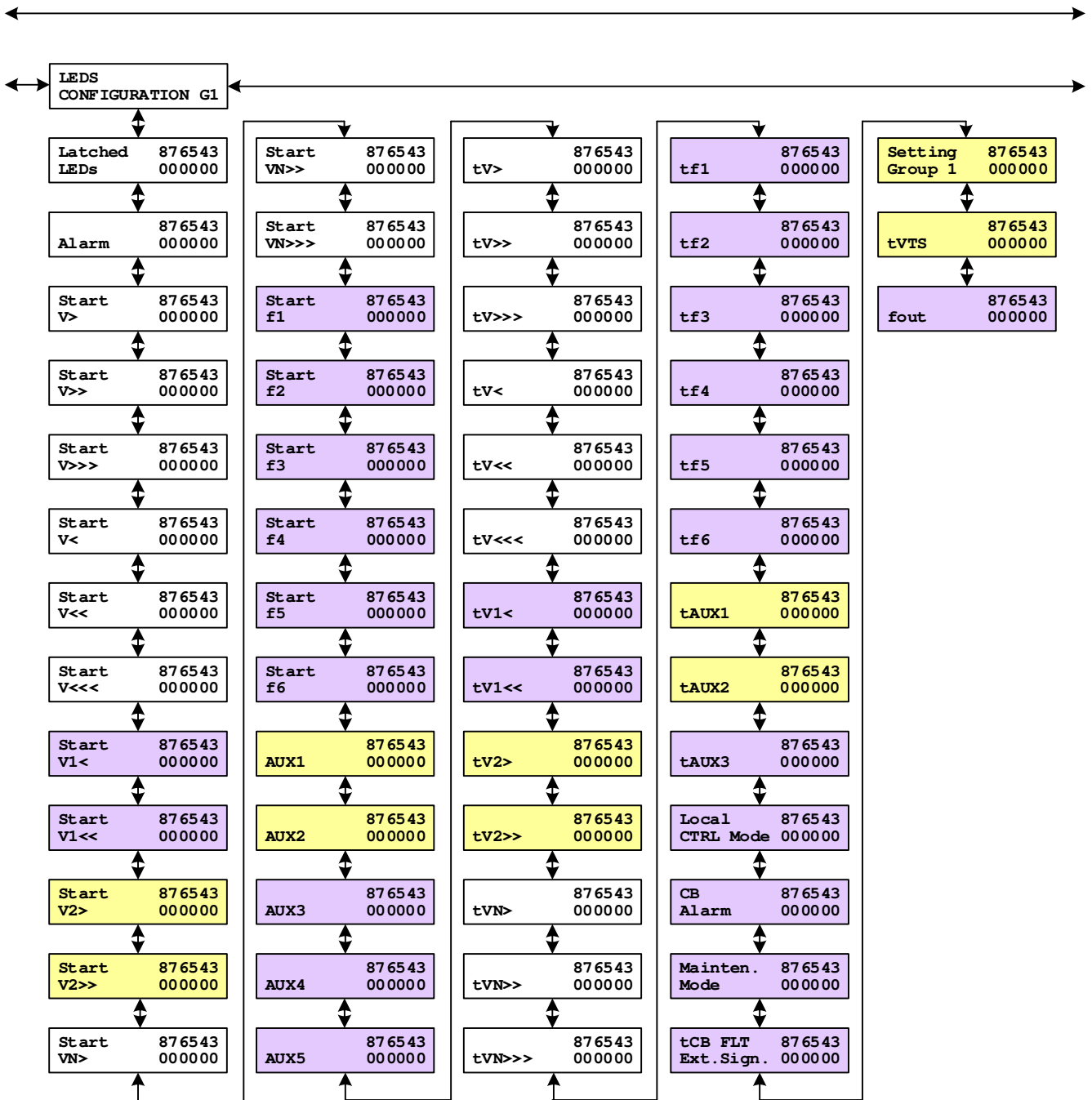

- Function available in all Models (L, N, A)
- Function available in Models: N, A only
- Function available in Model A only

PJ916END

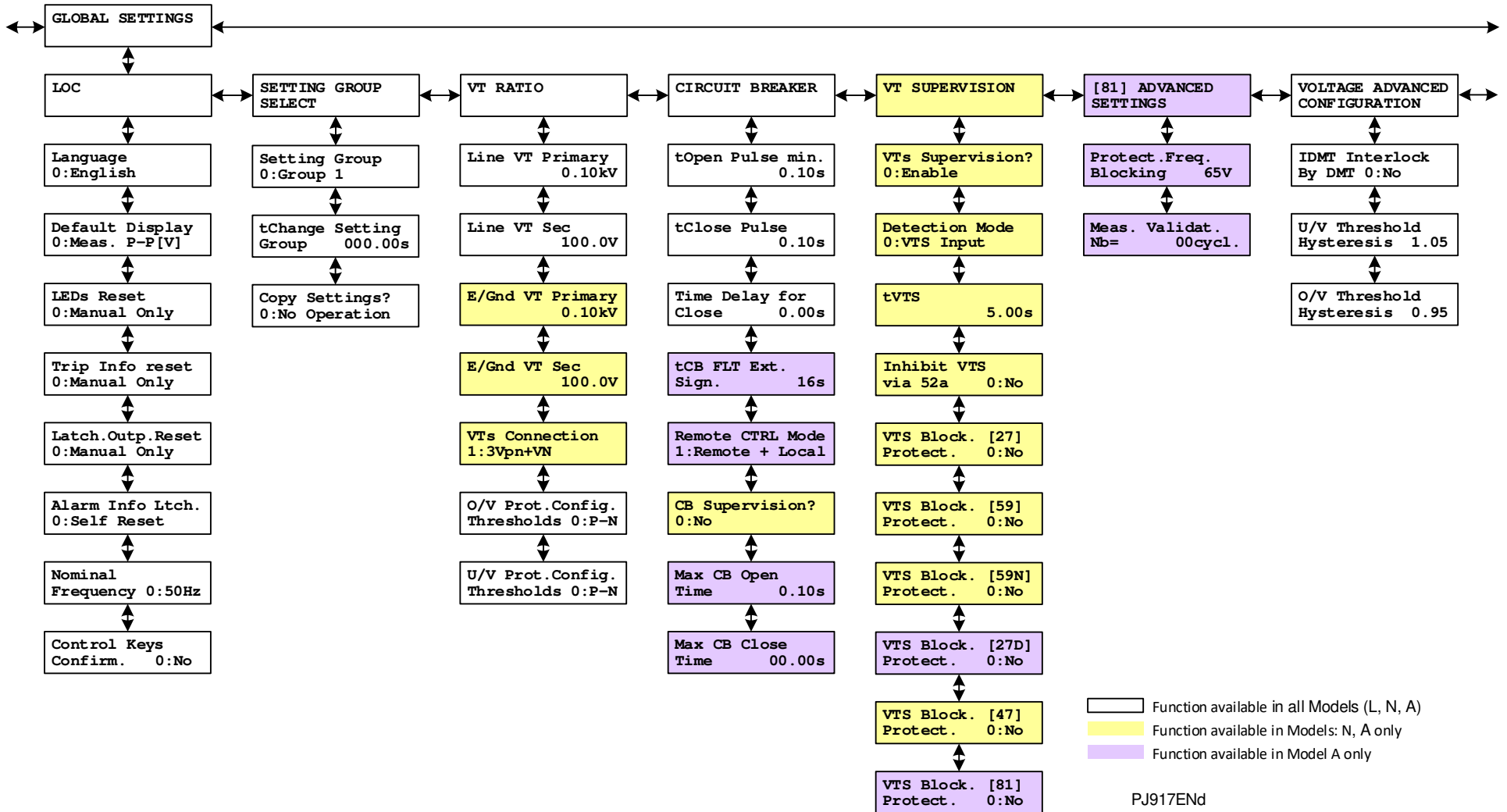

Function available in all Models (L, N, A)
 Function available in Models: N, A only
 Function available in Model A only

PJ917END

Figure 31. Menu map submenu part 6

Figure 32. Menu map submenu part 7

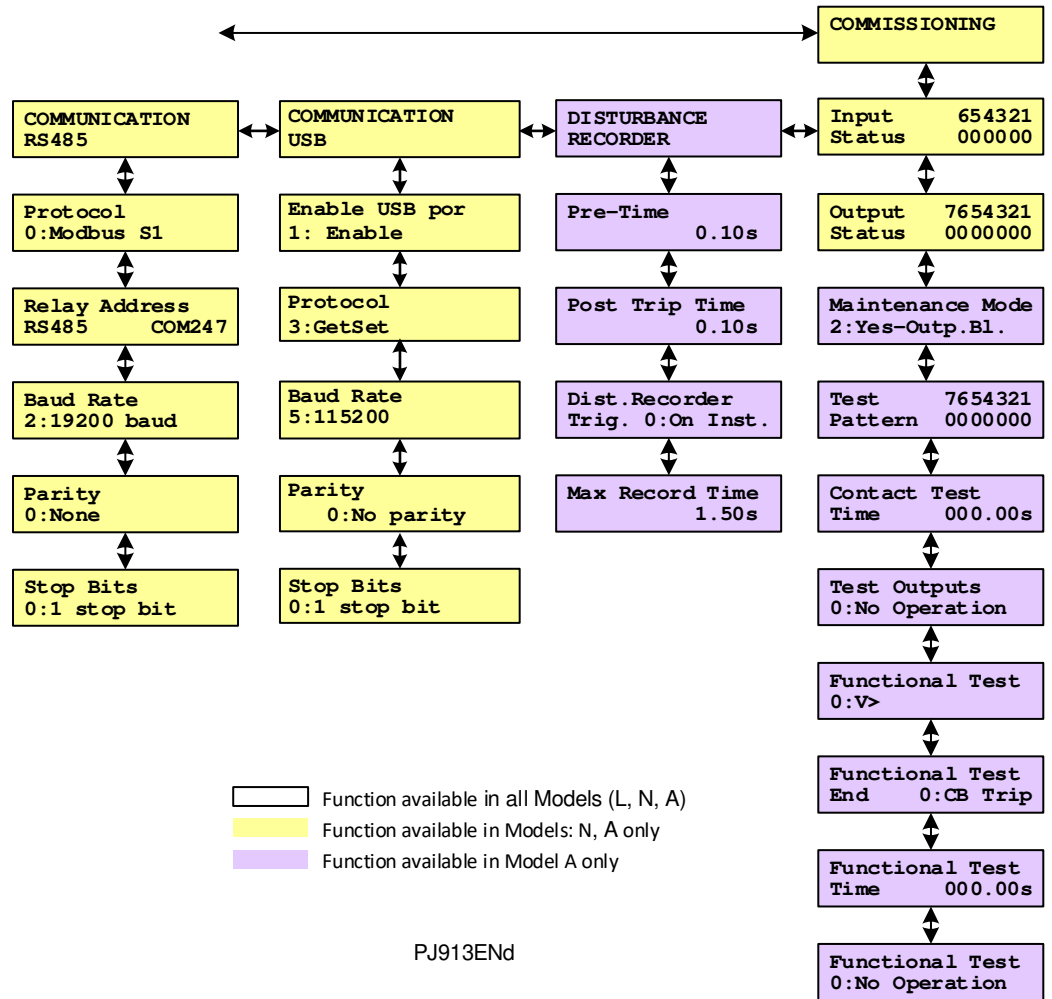

Functions and Parameters

Line VT Ratio

Applicable to Easergy P1V Series

L	N	A
----------	----------	----------

Description

The line VT ratio can be accessed in the protection menu and must always be set at the time of commissioning. It is used by all Easergy P1 functions which deal with the voltage.

NOTE: Good practice is to set this ratio before implementing the protection settings.

The parameter to be set is:

- Line VT ratio setting (**GLOBALSETTINGS/VT RATIO** menu cell).

NOTE: Two hardware versions of Easergy P1V are available, one for measurements with use of a voltage transformer and one for direct measurements.

Settings

Settings for the primary and secondary voltage can be found in **GLOBALSETTINGS/ VT RATIO** menu:

Available Setting	Authorized Values	Default Setting
Line VT Primary	0.05...65 kV (step: 0.01 kV)	0.1 kV (for Phase Range 50 – 130 V) 0.22 kV (for Phase Range 220 – 480 V)
Line VT Sec	57... 130 V (step: 0.1 V) 220... 480 V (step: 0.1 V)	100 V (for 57-130 VAC measuring range) 220 V (for 220-480 VAC measuring range)
VT Connection (A, N)	3Vpn 3Vpn+VN 2Vpp+VN 3Vpp+VN	3Upn+UN
Prot. Config. V>	P-N P-P	P-P
Prot. Config. V<	P-N P-P	P-P

NOTE: VT Connection, Prot. Config. V> and Prot. Config. V< correspond both to Line VT Ratio and Earth VT Ratio settings.

NOTE: All voltage settings are in secondary side voltage (transformed by VT). The voltage can be defined as phase to phase or phase to neutral measurements.

There are four possibilities for VT connections:

- 3Vpn – connected three voltage phase to neutral

- $3V_{pn} + V_N$ – connected three voltage phase to neutral and earth fault voltage (open delta)
- $2V_{pp} + V_N$ – connected two voltage phase to phase and earth fault voltage (open delta)
- $3V_{pp} + V_N$ – connected three voltage phase to phase and earth fault voltage (open delta)

Easergy Studio 9.0.0 (or higher) or eSetup Easergy Pro can be used to download and upload protection and configuration setting values via the relay's USB port.

Earth VT Ratio

Applicable to Easergy P1V Series

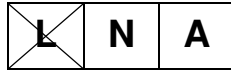

Description

The earth VT ratio can be accessed in the protection menu and must always be set at the time of commissioning. It is used by all Easergy P1V functions which deal with the earth fault voltage.

NOTE: Good practice is to set this ratio before implementing the protection settings.

The parameter to be set is:

- Earth VT ratio setting (*GLOBALSETTINGS/VT RATIO* menu cell).

NOTE: Two hardware versions of measuring neutral voltage in Easergy P1V are available, one for measurements (57-130V) with use of a voltage transformer and one for calculation neutral voltage as vector sum ($\vec{V}_a + \vec{V}_b + \vec{V}_c$).

Settings

Settings for the primary and secondary voltage ratings of both: the phase and the earth fault voltage transformers can be found in *PROTECTION / EARTH VT* menu

Available Setting	Authorized Values	Default Setting
E/Gnd VT Primary	0.05...65 kV (step: 0.01 kV)	0.1 kV
E/Gnd VT Sec	57... 130 V (step: 0.1 V)	100 V

Network Frequency

Applicable to Easergy P1V Series

L	N	A
---	---	---

Description

The network frequency can be accessed in the protection menu and must always be indicated (50 or 60 Hz) at the time of commissioning. It is used by all Easergy P1V functions which deal with the phase voltage and the neutral voltage.

Easergy P1V uses this parameter to adapt operation of the measurement and protection algorithms to the network frequency. If the setting is implemented incorrectly, the accuracy of the metering and protection functions will be seriously affected.

Settings

Settings for the network frequency selection can be found in **GLOBALSETTINGS/LOC/Nominal Frequency** menu:

Available Setting	Authorized Values	Default Setting
Nominal Frequency	50 or 60 Hz (step: N/A)	50 Hz

Overvoltage Protection [59]

Applicable to Easergy P1V Series

L	N	A
---	---	---

Description

Easergy P1V relays offer three independent stages both for phase and earth fault protection. For the first stage (59) it is possible to set a definite time delay (DT) or an inverse time delay (IDMT) with different types of curves (see below). Each stage and related time delay can be programmed to provide maximum selectivity.

In both functions the first stage reset delay type can be selected between DT or IDMT timer to reduce clearance times when intermittent faults occur. Phase overvoltage protection function (59) can also be configured as the undervoltage function ("OR TRIP", "AND TRIP", "OR Alarm", "AND Alarm" etc.).

The Easergy P1V relay has separate instantaneous and delayed indications for each stage. Output relays and LEDs can be configured to indicate the faulted phase(s). Each protection function can be disabled, enabled, configured to trip a circuit breaker or as alarm signal only.

Each protection stage can be selected to Trip the CB (works when all three phases are faulty – AND option, or if in any one phase fault appears – OR option) or to indicate a signal (Alarm) only, there is possibility to choose trip and alarm with blocking option from state of CB contacts (52a).

If an overvoltage protection stage (V>, V>> or V>>>) is set to **Trip**, it means that stage is linked to the **Protect.Trip** and **Prot.Trip pulse**.

If an overvoltage protection stage (V>, V>> or V>>>) is set to **Alarm**, it means that that stage is linked to the **Alarm** function.

- If **OR Trip** is selected, the overvoltage stage will trip when any phase is faulty (works similarly for alarm option).
- If **AND Trip** is selected, the overvoltage stage will trip when all phases are faulty (works similarly for alarm option).
- If **OR Trip/52a** is selected, the overvoltage stage will trip when any phase is faulty and there is confirmation of closed state of breaker (works similarly for alarm option).
- If **AND Trip/52a** is selected, the overvoltage stage will trip when all phases are faulty and there is confirmation of closed state of breaker (works similarly for alarm option).

Block Diagram

Figure 33. Block diagram of Overvoltage Protection (59)

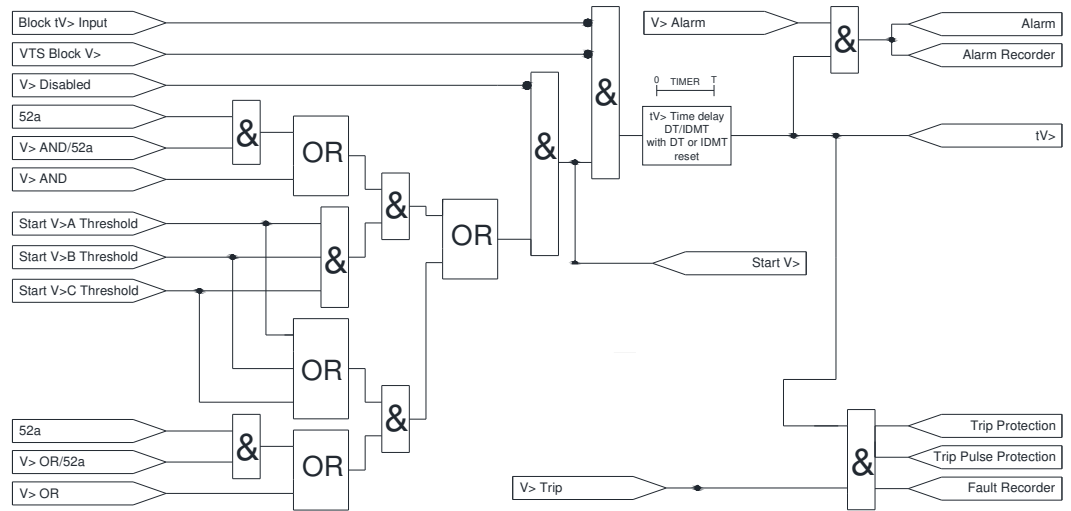

Standard Operation

For more information about types of IDMT characteristics, time-delay characteristic and time delayed reset characteristic refer to *Overvoltage and Undervoltage Protection Tripping Curves section of this manual.*

Settings

Menu Text	Authorized Values	Default Setting
V> ?	Disabled OR Trip OR Alarm AND Trip AND Alarm OR Trip/52a (NA) OR Alarm/52a (NA) AND Trip/52a (NA) AND Alarm/52a (NA)	Disabled
V> Threshold	5... 200 V (step: 0.1 V) 20... 720 V (step: 0.1 V)	20 V 20 V
V> Delay Type	DT IEC_SI IEC_VI IEC_EI IEC_LTI UK_STI RECT RI IEEE_MI IEEE_VI IEEE_EI CO2_Px20 US_CO8 RXIDG BPN_EDF CO2_Px40	DT
tV> /TMS/TD	0.02... 200 s (step: 0.01 s)	0.02 s
V> Reset Delay Type	DT High State IDMT	DT High State
V> DMT tReset	0... 600 s (step: 0.01 s)	0 s
V>> ?	Disabled OR Trip OR Alarm AND Trip AND Alarm OR Trip/52a (NA) OR Alarm/52a (NA) AND Trip/52a (NA) AND Alarm/52a (NA)	Disabled

V>> Threshold	5... 200 V (step: 0.1 V) 20... 720 V (step: 0.1 V)	40 V 40 V
tV>>	0.02... 200 s (step: 0.01 s)	0.02 s
V>>> ?	Disabled OR Trip OR Alarm AND Trip AND Alarm OR Trip/52a (NA) OR Alarm/52a (NA) AND Trip/52a (NA) AND Alarm/52a (NA)	Disabled
V>>> Threshold	5... 200 V (step: 0.1 V) 20... 720 V (step: 0.1 V)	50 V 50 V
tV>>>	0.02... 200 s (step: 0.01 s)	0.02 s

IDMT tripping can be blocked if any DMT stage is started, settings: **IDMT interlock by DMT (GLOBAL SETTINGS/O/V ADVANCED** column). These settings is common for **E/Gnd Fault O/V [59N], Phase O/V [59] and Phase U/V [27]**

Menu Text	Authorized Values	Default Setting
IDMT interlock by DMT stage	No Yes	No
[27] Hysteresis	1... 1.2 (step: 0.1)	1.05
[59] Hysteresis	0.80... 1.00 (step: 0.01)	0.95

Additional Functions

Blocking Logic

Easergy P1V relays provide definite and independent time-delayed overvoltage protection.

Each Phase voltage input is associated with three stages.

The first stage for earth fault can be set to definite time-delay or inverse time-delay using the IEC_SI, IEC_VI, IEC_EI, IEC_LTI, UK_STI, C02_P20, US_C08, IEEE_MI, IEEE_VI, IEEE_EI, RXIDG, BPN EDF, RI, RECT, C02_P40 curves. Their parameters are shown above in this section.

The third stage for overvoltage can be set as definite time-delay only.

The instantaneous stages for overvoltage elements are labeled “V>” for the first stage, “V>>” and “V>>>” for the second and third instantaneous stages respectively.

The time-delayed overvoltage stages are labeled “tV>” for the first stage, “tV>>” and “tV>>>” for the second and third time-delayed stages respectively.

The protection elements trip when the following conditions are realized:

- a phase to phase or phase to neutral voltages exceeds the set overvoltage threshold,
- the relevant time-delay has elapsed,
- the blocking logic (if used) is not activated.

Figure 34. Diagram showing the functionality of Blocking Logic

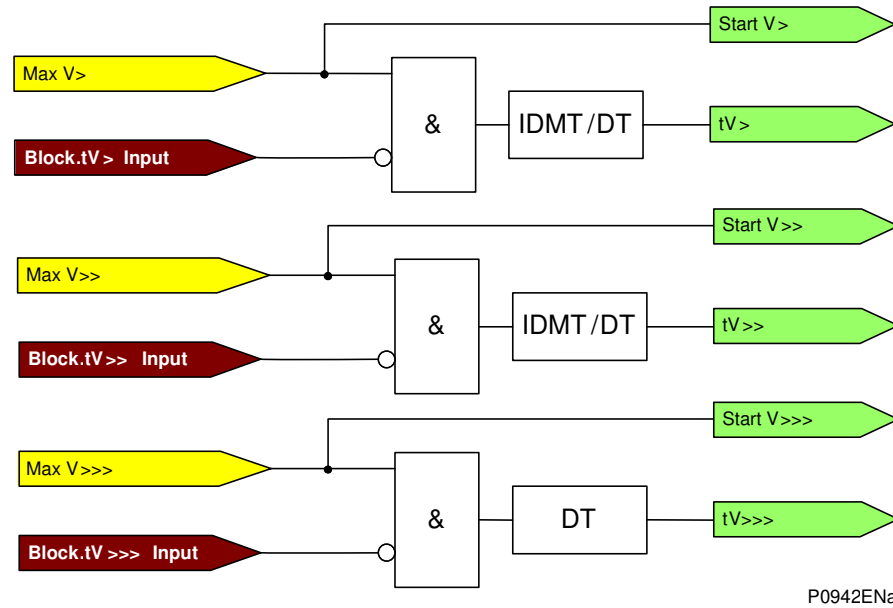

P0942ENa

The logic associated with the earth fault stage is identical to the logic described above. The stages V> & tV>, V>> & tV>> and V>>> & tV>>> are respectively replaced by the stages VN> & tVN>, VN>> & tVN>>, VN>>> & tVN>>>.

Thanks to the "Blocking Logic" function, it is possible to freeze the timer as long as the "Block Logic" signal is active.

As soon as the blocking "Block Logic" signal drops, if the overvoltage value is still over the set threshold, the time-delay resumes using the value prior to the activation of the blocking function as its new initial value. This allows faster clearance of the fault after resetting of the "Block Logic" signal.

Instantaneous function

As soon as a phase (or earth) timer stage starts running, the instantaneous output associated with that stage is activated. This output indicates that the protection element has detected a phase (or earth) fault and that the corresponding time-delay has started. This time-delay can be blocked via the associated "Block Logic" logic input. If this blocking input is activated by an output contact of a downstream relay, the logic that will lead to the trip command is then blocked only if the relay that is the closest to the fault can see and therefore eliminate the fault. This principle is known as «Blocking logic» or «Blocking». It is described in more detail above.

DMT timer stages

The three phase (earth) overvoltage stages can be assigned definite time-delays. The time to operate is equal to the set time-delay plus the time for the output contact to operate and the time required to detect the overvoltage condition.

For DMT stages, a definite-time "tReset" reset timer is associated with the first phase overvoltage stage, and with the first earth fault stage.

IDMT timer stages

The first and the second (V>, V>>) and earth fault (VN>) overvoltage stages can be selected with an inverse maximum time (IDMT) characteristic.

The time-delay in relay operation is calculated with a mathematical formula that depends on the relay voltage and TMS (IEC and UK) or TD (IEEE and US) values.

There are twelve inverse time characteristics available (all of them described above in this section of the manual).

Reset Timer

The first overvoltage [V>] and the first earth fault [VN>] stages have a reset timer. The value that is set for this reset timer corresponds to the minimum time during which the voltage value needs to be lower than 95% of the phase to phase or phase to neutral (or earth) threshold before the corresponding phase (or earth) time-delay is reset.

NOTE: This rule does not apply when the protection element is triggered. When the protection element is triggered, the time-delay $t_{V>}$ (or $t_{VN>}$) is immediately reset.

DMT stages have DMT reset timers only.

IDMT characteristics can be associated with either a DMT or an IDMT reset timer. This selection is made in the menu: **SETTING GROUP x/PROTECTION Gx/[59] PHASE O/V Gx/Reset Delay Type: 0:DT High State or 1: IDMT**

Additional Options

By default function is off.

Undervoltage Protection [27]

Applicable to Easergy P1V Series

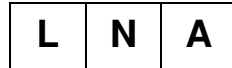

Description

The undervoltage protection included in the P1V relays provides three-stage undervoltage protection with independent time-delay characteristics (DT or IDMT – depending on stage), which can be set to operate from phase to phase or phase to neutral voltage. All undervoltage settings apply to all three phases but are independent for each of the three stages.

Each protection stage can be also selected to Trip the CB (works when all three phases are faulty – AND option, or if any one phase is faulty – OR option) or to indicate a signal (Alarm) only, there is possibility to choose trip and alarm with blocking option from state of CB contacts (52a).

If an overvoltage protection stage ($V<$, $V<<$ or $V<<<$) is set to **Trip**, it means that that stage is linked to the **Protect.Trip** and **Prot.Trip pulse** functions .

If an undervoltage protection stage ($V<$, $V<<$ or $V<<<$) is set to **Alarm**, it means that that stage is linked to the **Alarm** function.

- If **OR Trip** is selected, the undervoltage stage will trip when any phase is faulty (works similarly for alarm option).
- If **AND Trip** is selected, the undervoltage stage will trip when all phases are faulty (works similarly for alarm option).
- If **OR Trip/52a** is selected, the undervoltage stage will trip when any phase is faulty and there is confirmation of closed state of breaker (works similarly for alarm option).
- If **AND Trip/52a** is selected, the undervoltage stage will trip when all phases are faulty and there is confirmation of closed state of breaker (works similarly for alarm option).

Block Diagram

Figure 35. Block diagram of Undervoltage Protection function

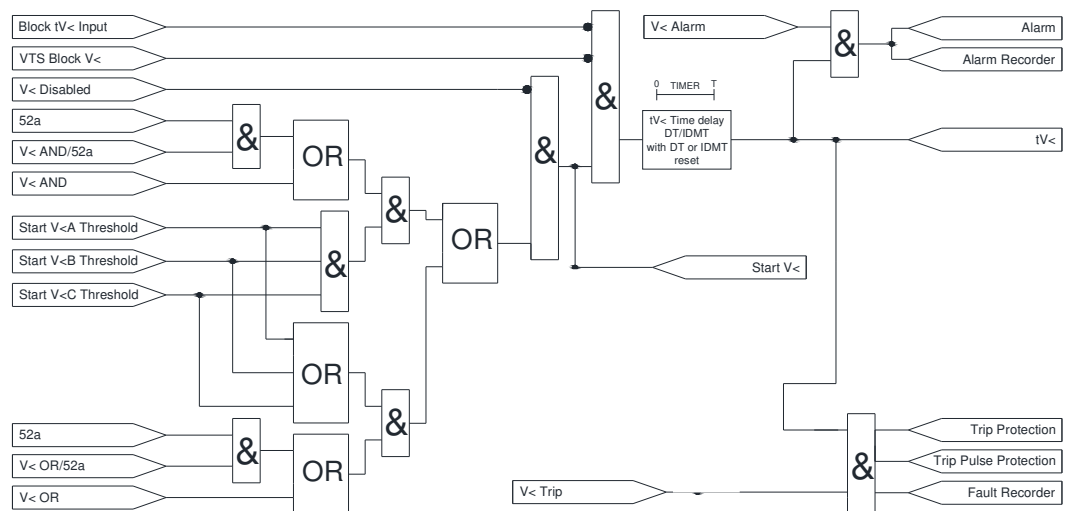

Standard Operation

For more information about types of IDMT characteristics, time-delay characteristic and time delayed reset characteristic refer to *Overvoltage and Undervoltage Protection Tripping Curves section of this manual*.

Settings

Menu Text	Authorized Values	Default Setting
V< ?	Disabled OR Trip OR Alarm AND Trip AND Alarm OR Trip/52a (NA) OR Alarm/52a (NA) AND Trip/52a (NA) AND Alarm/52a (NA)	Disabled
V< Threshold	5... 130 V (step: 0.1 V) 20... 480 V (step: 0.1 V)	20 V 20 V
V< Delay Type	DT IEC_SI IEC_VI IEC_EI IEC_LTI UK_STI RECT RI IEEE_MI IEEE_VI IEEE_EI CO2_Px20 US_CO8 RXIDG BPN_EDF CO2_Px40	DT
tV< /TMS/TD	0.02... 200 s (step: 0.01 s)	0.02 s
V< Reset Delay Type	DT High State IDMT	DT High State
V< DMT tReset	0... 600 s (step: 0.01 s)	0 s
V<< ?	Disabled OR Trip OR Alarm AND Trip AND Alarm OR Trip/52a (NA) OR Alarm/52a (NA) AND Trip/52a (NA) AND Alarm/52a (NA)	Disabled
V<< Threshold	5... 130 V (step: 0.1 V) 20... 480 V (step: 0.1 V)	40 V 40 V
tV<<	0.02... 200 s (step: 0.01 s)	0.02 s
V<<< ?	Disabled OR Trip OR Alarm AND Trip AND Alarm OR Trip/52a (NA) OR Alarm/52a (NA) AND Trip/52a (NA) AND Alarm/52a (NA)	Disabled
V<<< Threshold	5... 130 V (step: 0.1 V) 20... 480 V (step: 0.1 V)	50 V 50 V
tV<<<	0.02... 200 s (step: 0.01 s)	0.02 s

Additional Functions

Easergy P1V relays provide definite and independent time-delayed undervoltage protection.

Each phase voltage input is associated with three stages.

The first timer stage for phase undervoltage can be set to definite time-delay or inverse time-delay using the IEC_SI, IEC_VI, IEC_EI, IEC_LTI, UK_STI, C02_P20, US_C08, IEEE_MI, IEEE_VI, IEEE_EI, RXIDG, BPN EDF, RI, RECT, C02_P40 curves. Their parameters are shown in the *Overvoltage Protection section of this manual*.

The second and third stage for undervoltage can be set as definite time-delay only.

The instantaneous stages are labeled “V<” for the first stage, “V<<” and “V<<<” for the second and third instantaneous stages respectively.

The time-delayed stages are labeled “tV<” for the first stage, “tV<<” and “tV<<<” for the second and third time-delayed stages respectively.

The protection elements trip when the following conditions are met:

- a phase to phase or phase to neutral voltages exceeds the set undervoltage threshold,
- the relevant time-delay has elapsed,
- the blocking logic (if used) is not activated.

The first phase undervoltage stages [V</tV<] has a reset timer.

The value that is set for this reset timer corresponds to the minimum time during which the voltage value needs to be higher than 102% of threshold before the corresponding phase time-delay is reset.

NOTE: This rule does not apply when the protection element is triggered. When the protection element is triggered, the time-delay tV< is immediately reset.

All other information about undervoltage functions are similar to overvoltage function. Refer to *Overvoltage Protection section of this manual*

Additional Options

By default finction is off.)

Earth Fault Overvoltage Protection [59N]

Applicable to Easergy P1V Series

L	N	A
---	---	---

Description

In the Easergy P1V relays the Earth fault element operates from a measured (NA) or calculated from phase to neutral or phase to phase voltages (L) earth fault voltage value.

The first earth fault stage has time-delayed characteristics which are selectable between inverse definite minimum time (IDMT) and definite time (DT). The second and third stages have a definite time characteristic only.

If an earth fault stage (VN>, VN>> or VN>>>) is set to **Trip**, it means that that stage is linked to the **Protect.Trip** and **Prot.Trip pulse** functions.

If an earth fault stage (VN>, VN>> or VN>>>) is set to **Alarm**, it means that that stage is linked to the **Alarm** function.

- If **Trip (measured)** is selected, the earth fault stage will trip from measured zero sequence of voltage.
- If **Alarm (measured)** is selected, the earth fault stage will indicate alarm from measured zero sequence of voltage.
- If **Trip (Ua+Ub+Uc)** is selected, the earth fault stage will trip from calculated zero sequence of voltage.
- If **Alarm (Ua+Ub+Uc)** is selected, the earth fault stage will indicate alarm from calculated zero sequence of voltage

Block Diagram

Figure 36. Block diagram of Earth Fault Overvoltage Protection (59N) function

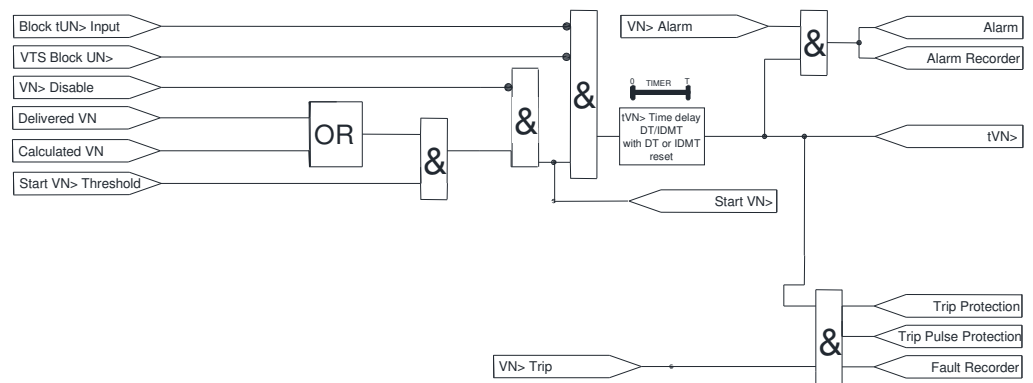

Standard Operation

For more information about types of IDMT characteristics, time-delay characteristic and time delayed reset characteristic refer to **Overvoltage and Undervoltage Protection Tripping Curves section of this manual**.

Settings

Menu Text	Authorized Values	Default Setting
VN> ?	Disabled Trip (measured) (NA) Alarm (measured) (NA) Trip (Ua+Ub+Uc) Alarm (Ua+Ub+Uc)	Disabled
VN> Threshold	0.5... 130 V (step: 0.1 V)	5 V
VN> Delay Type	DT IEC_SI IEC_VI IEC_EI IEC_LTI UK_STI RECT RI IEEE_MI IEEE_VI IEEE_EI CO2_Px20 US_CO8 RXIDG BPN_EDF CO2_Px40	DT
tVN> /TMS/TD	0.02... 200 s (step: 0.01 s)	0.02 s
VN> Reset Delay Type	DT High State IDMT	DT High State
VN> DMT tReset	0... 600 s (step: 0.01 s)	0 s
VN>> ?	Disabled Trip (measured) (NA) Alarm (measured) (NA) Trip (Ua+Ub+Uc) Alarm (Ua+Ub+Uc)	Disabled
VN>> Threshold	0.5... 130 V (step: 0.1 V)	10 V
tVN>>	0.02... 200 s (step: 0.01 s)	0.02 s
VN>>> ?	Disabled Trip (measured) (NA) Alarm (measured) (NA) Trip (Ua+Ub+Uc) Alarm (Ua+Ub+Uc)	Disabled
VN>>> Threshold	0.5... 130 V (step: 0.1 V)	15 V
tVN>>>	0.02... 200 s (step: 0.01 s)	0.02 s

Additional Functions

Easergy P1V relays provide definite and independent time-delayed overvoltage protection.

Each earth voltage (or calculated earth voltage) input is associated with three stages.

The first stage for earth fault can be set to definite time-delay or inverse time-delay using the IEC_SI, IEC_VI, IEC_EI, IEC_LTI, UK_STI, C02_P20, US_CO8, IEEE_MI, IEEE_VI, IEEE_EI, RXIDG, BPN EDF, RI, RECT, C02_P40 curves. Their parameters are shown in the *Overvoltage Protection section of this manual*.

The second and third stage for earth fault overvoltage can be set as definite time-delay only.

The instantaneous stages for earth fault elements are labeled “VN>” for the first stage, “VN>>” and “VN>>>” for the second and third instantaneous stages respectively.

The time-delayed earth fault stages are labeled “tVN>” for the first stage, “tVN>>” and “tVN>>>” for the second and third time-delayed stages respectively.

The protection elements trip when the following conditions are realized:

- a phase to phase or phase to neutral voltages exceeds the set overvoltage threshold,

- the relevant time-delay has elapsed,
- the blocking logic (if used) is not activated.

All other information about earth fault overvoltage functions are similar to overvoltage function. Refer to *Overvoltage Protection section of this manual*

Additional Options

By default functions is off.

Overvoltage and Undervoltage Protection Tripping Curves

Applicable to Easergy P1V Series

L	N	A
----------	----------	----------

Description

Operation Time-Delay

The first stage (V>) of overvoltage and undervoltage (V<) protection have time -delayed characteristics which are selectable between inverse definite minimum time (IDMT) and definite time (DT). The second and third (V>>, V>>>, V<<, V<<<) stages has a definite time characteristic only.

The inverse time-delayed characteristics comply with the following formula:

- IEC/UK/FR curves:

$$t = TMS \cdot \left(\frac{k}{\left(\frac{G}{G_s}\right)^\alpha - P} + c \right)$$

- For IEEE/US standard curves:

$$t = TD \cdot \left(\frac{k}{\left(\frac{G}{G_s}\right)^\alpha - P} + c \right)$$

where:

- t* - operating time in [s],
- k*, *P*, *c* - constants,
- G* - measured voltage in [V],
- TMS* - time multiplier setting for IEC curves,
- TD* - time dial setting for IEEE curves,
- G_s* - voltage threshold setting in [V],
- α* - constant.

Type of Curve according to IEC 60255-151 std definition	Standard	k	c	α	P
IEC Standard Inverse Time (SI)	IEC/A	0.14	0	0.02	1
IEC Very Inverse Time (VI)	IEC/B	13.5	0	1	1
IEC Extremely Inverse Time (EI)	IEC/C	80	0	2	1
IEC Long Time Inverse (LTI)	IEC	120	0	1	1
FR Short Time Inverse (STI)	FR	0.05	0	0.04	1
UK Rectifier (Rect)	UK	45900	0	5.6	1
IEEE Moderately Inverse Time (MI)	IEEE (IEC/D)	0.0515	0.114	0.02	1
IEEE Very Inverse Time (VI)	IEEE (IEC/E)	19.61	0.491	2	1
IEEE Extremely Inverse Time (EI)	IEEE (IEC/F)	28.2	0.1217	2	1
US Time Inverse (CO8)	US	5.848	0.1654	2	1
US Short Time Inverse (CO2 P20)	US	0.02394	0.01694	0.02	1
US Short Time Inverse (CO2 P40)	US	0.16758	0.11858	0.02	1
BNP (EDF)	EDF	1000	0.655	2	1
RI		-4.2373	0	-1	1.43644

A time multiplier setting TMS is used to adjust the operating time of IEC & UK IDMT curves.

A time multiplier setting TD is used to adjust the operating time of IEEE or US IDMT curves.

NOTE:

1. For (CO2 P20), TD is defined like in MiCOM P20 series
2. For (CO2 P40), TD is defined like in MiCOM P40 series

The difference between above two characteristics is in definition of TD setting value only.

Figure 37. The inverse time-delayed characteristics

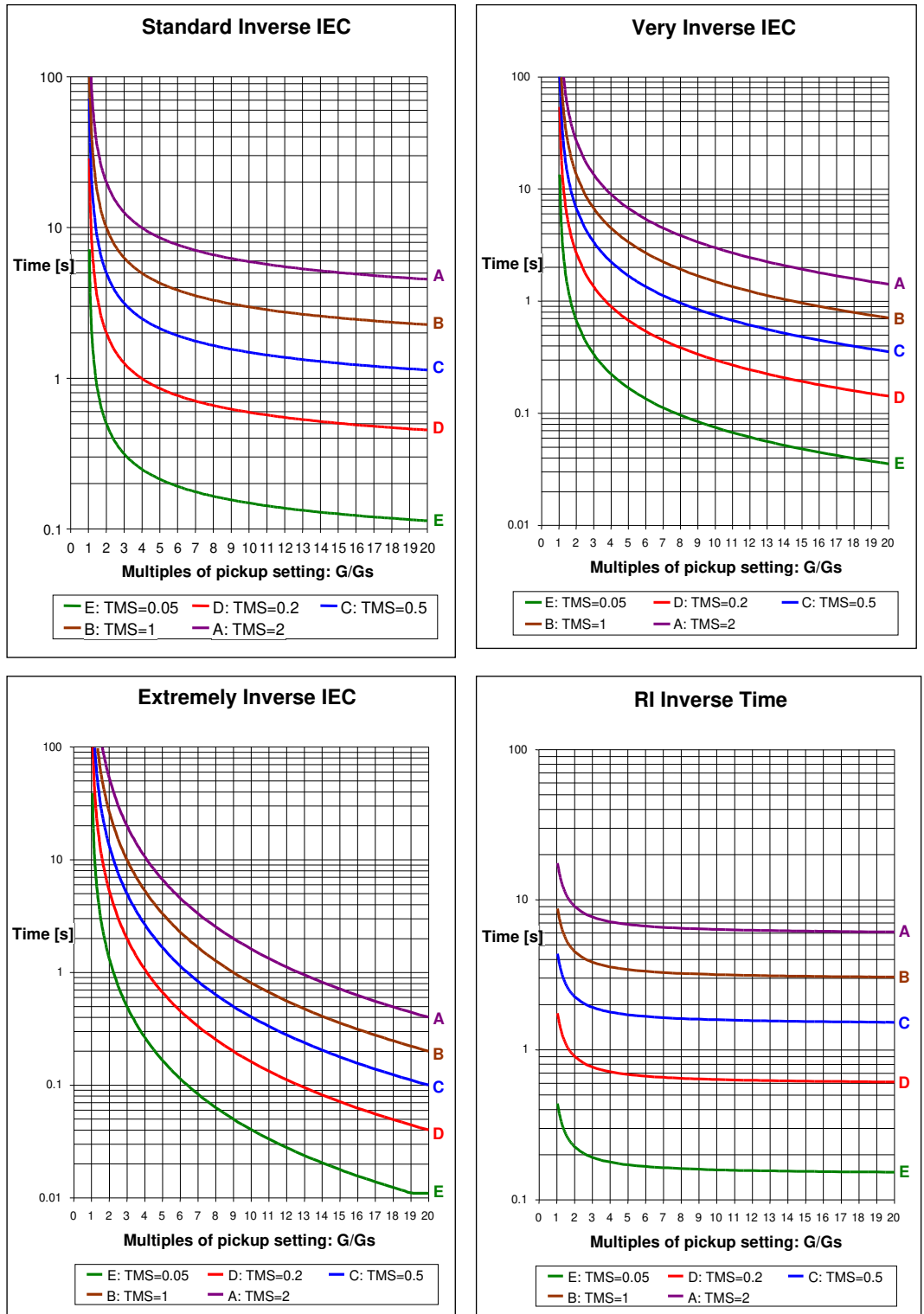

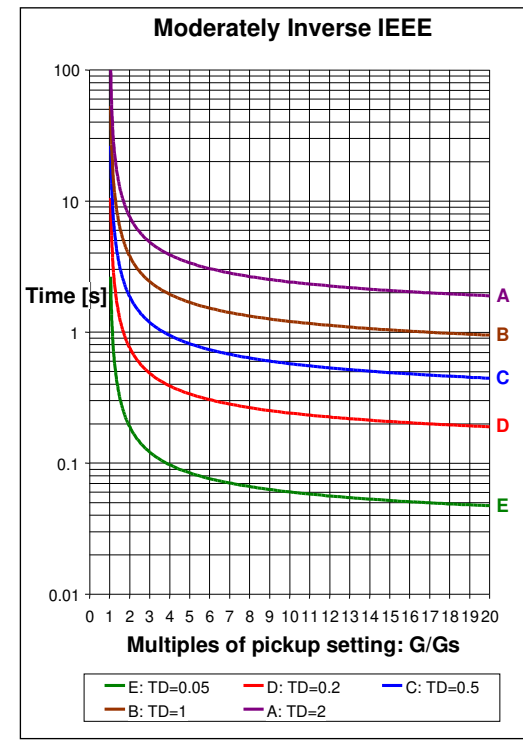
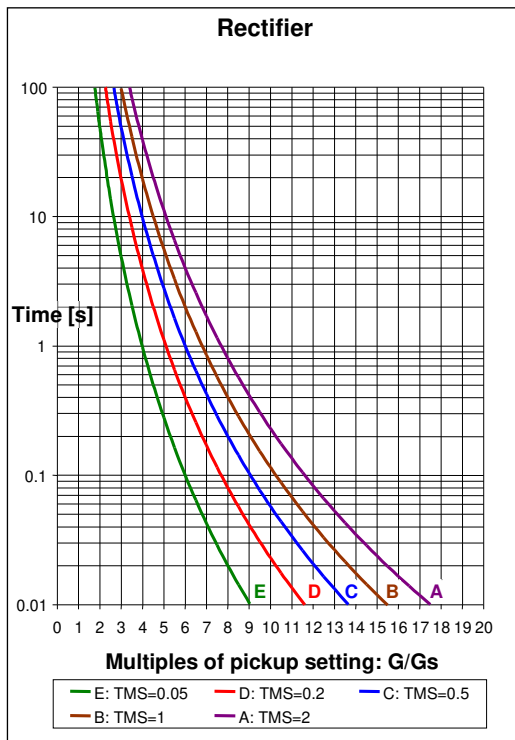
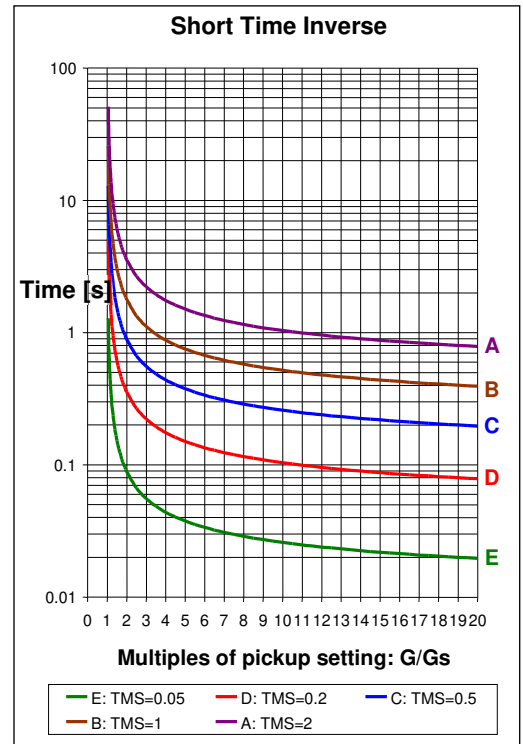
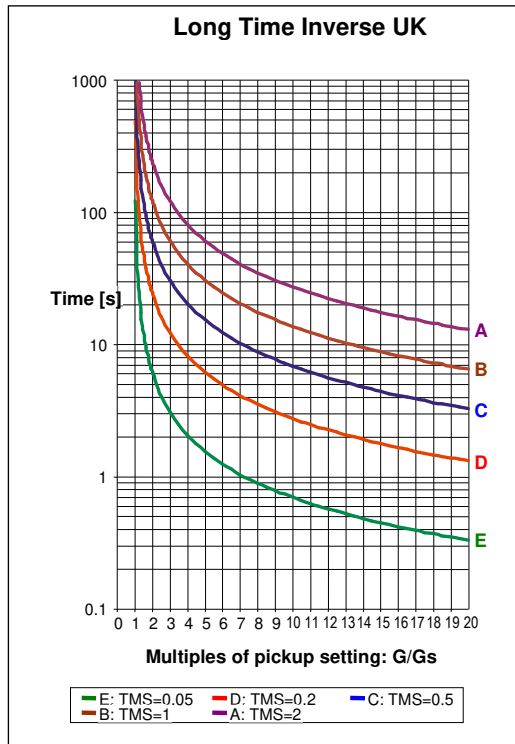

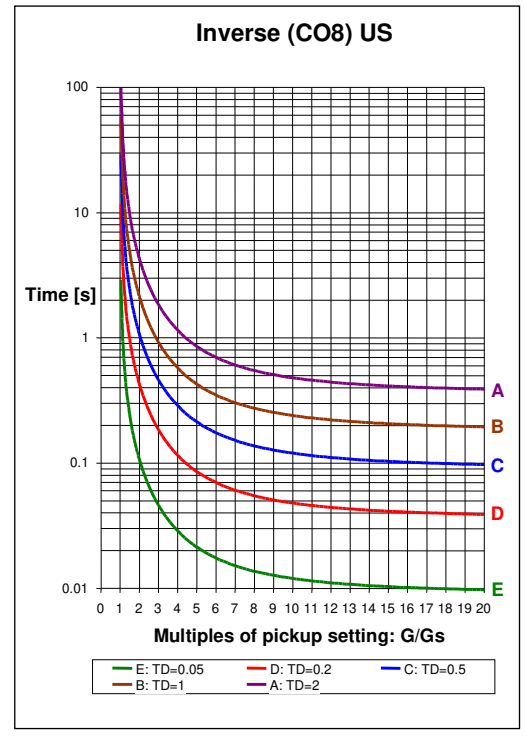
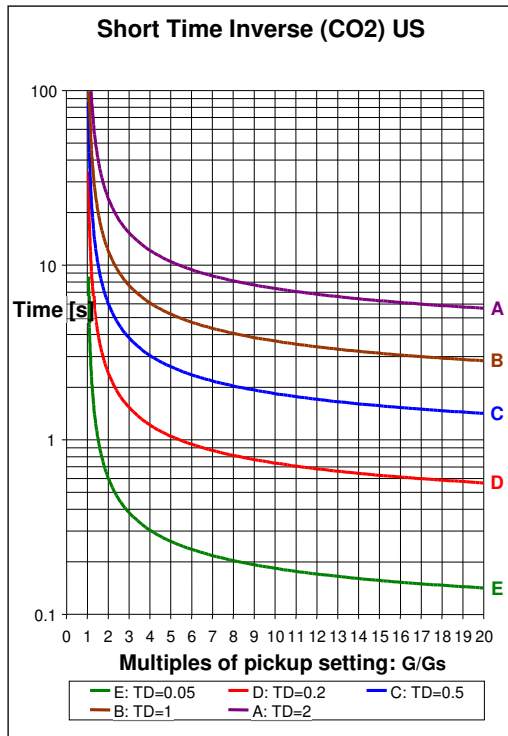
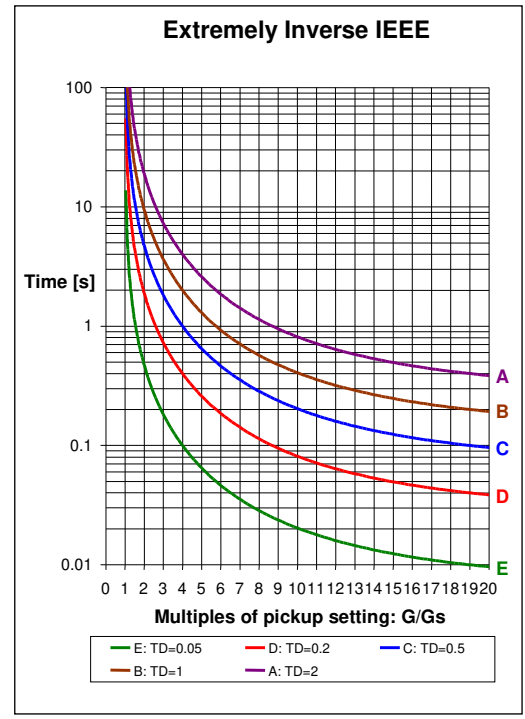
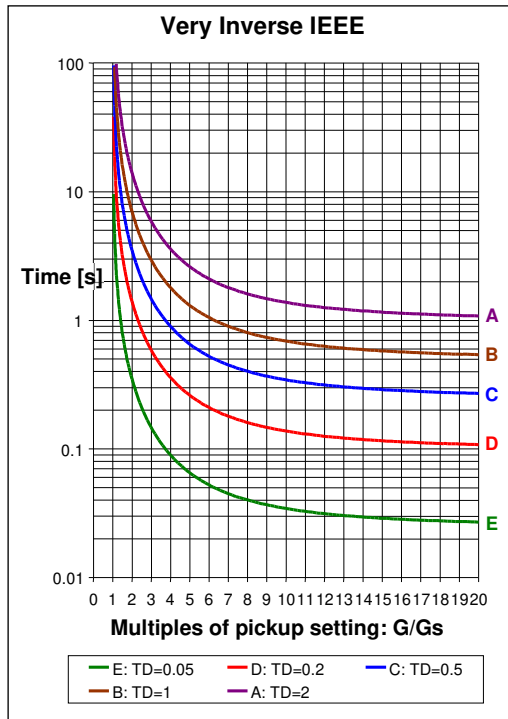

RXIDG Curves

The curves available follow the formula:

$$t = 5.8 - 1.35 \cdot \ln \left(\frac{1}{k \left(\frac{Gs}{G} \right)} \right)$$

where:

- t - tripping time
- k - coefficient (from 0.3 to 1, by steps of 0.01)
- Us - value of the programmed threshold (Pick-up value)
- U - value of measured voltage

DMT Reset Timer

For the first phase and earth overvoltage stages, the Easergy P1V has a timer hold facility, **DMT tReset**, which can be set to a definite time value or to an inverse time characteristic.

This timer hold facility is used to reduce fault clearance times and is also useful in situations where intermittent faults may be experienced. This can for example be the case on a plastic insulated cable. In that case, the fault energy may cause the cable insulation to melt and reseal, thereby extinguishing the fault. This process repeats itself a couple of times giving a succession of fault voltage pulses, each of increasing duration with reducing intervals between the pulses, until the fault becomes permanent.

When the reset time of the overvoltage relay is instantaneous the relay will be repeatedly reset and unable to trip until the fault becomes permanent. By using the Timer Hold facility, the relay will integrate the fault voltage pulses, thereby reducing fault clearance time.

The Easergy P1V's reset timer **DMT tReset** can be found in the following menu cell:
SETTING GROUP x/PROTECTION Gx /[59] PHASE O/V Gx /DMT tReset

Reset IDMT Characteristic

IEEE/US /IEC

The IEEE/US/IEC curves may have an inverse time reset characteristic (**V>**, **Reset Delay Type 1: IDMT** setting) or instantaneous reset (**V>**, **Reset Delay Type 0:DMT** setting). If IDMT reset is selected (**V>**, **Reset Delay Type 1: IDMT** setting) then the following menu will be available: **V>**, **RTD/RTMS RESET**. The following equation can be used to calculate the inverse reset time for IEEE/IEC curves:

IEC:

$$resetime = RTMS \frac{tr}{1 - \left(\frac{G}{Gs}\right)^P}$$

IEEE:

$$resetime = RTD \cdot \frac{tr}{1 - \left(\frac{G}{Gs}\right)^P}$$

where:

- RTD** - Time dial setting for IEEE/US curves,
- RTMS** - A time multiplier setting for IEC curves,
- tr, P** - Constants (see table below).
- G** - Measured voltage in [V],
- Gs** - Voltage threshold setting in [V],

NOTE: To be in line with IEEE/IEC the RTMS (RTD) value should be equal to the TMS (TD) value. The setting for RTMS or RTD is given to adjust the reset characteristic to specific applications. Typically RTMS = TMS and RTD = TD.

Type of Curve	Standard	tr	P
IEC Standard Inverse Time (SI)	IEC/A	12.1	2
IEC Very Inverse Time (VI)	IEC/B	43.2	2
IEC Extremely Inverse Time (EI)	IEC/C	80	2
IEC Long Time Inverse (LTI)	IEC	0	2
FR Short Time Inverse (STI)	FR	0	2
UK Rectifier (Rect)	UK	0	2
IEEE Moderately Inverse Time (MI)	IEEE (IEC/D)	4.9	2
IEEE Very Inverse Time (VI)	IEEE (IEC/E)	21.6	2
IEEE Extremely Inverse Time (EI)	IEEE (IEC/F)	29.1	2
Time Inverse (CO8)	US	5.95	2
Short Time Inverse (CO2 P20)	US	2.261	2
Short Time Inverse (CO2 P40)	US	2.261	2
BNP EDF	BNP EDF	0	2
RXIDG	RXIDG	0	0

NOTE:

1. For CO2_P20, RTD is defined like in MiCOM P20 series
2. For CO2_P40, RTD is defined like in MiCOM P40 series

The difference between above two characteristics is in definition of TD setting value only.

Reset DMT Characteristic

If **Reset Delay Type** for V> is set as DT high state, the Reset Delay Type is consequently a DMT type. This applies independently from Reset Delay Type cell setting.

Negative Sequence Overvoltage Protection [47]

Applicable to Easergy P1V Series

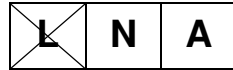

Description

This function is used to provide protection against unbalance resulting from phase inversion or unbalanced supply.

The negative sequence overvoltage element included in the Easergy P1V (N, A) relays provides two stage non-directional negative sequence overvoltage protection with independent time-delay characteristics. These characteristics are selectable between inverse definite minimum time (IDMT) and definite time (DT) for first stage, second stage can operate only with DT characteristic.

If the **V2>** protection element is set to **Trip**, it means that the element is linked to the **Protect.Trip** and **Prot.Trip pulse** functions.

If the **V2>** protection element is set to **Alarm**, it means that that element is linked to the **Alarm** function.

- If **Trip** is selected, the negative sequence overvoltage stage will trip when negative sequence of voltage exceeds set threshold value.
- If **Alarm** is selected, the negative sequence overvoltage stage will indicate when negative sequence of voltage exceeds set threshold value.
- If **Trip/52a** is selected, the negative sequence overvoltage stage will trip when negative sequence of voltage exceeds set threshold value and there is a confirmation of closed state of breaker.
- If **Alarm/52a** is selected, the negative sequence overvoltage stage will indicate then negative sequence of voltage exceeds set threshold value and there is a confirmation of closed state of breaker.

Block Diagram

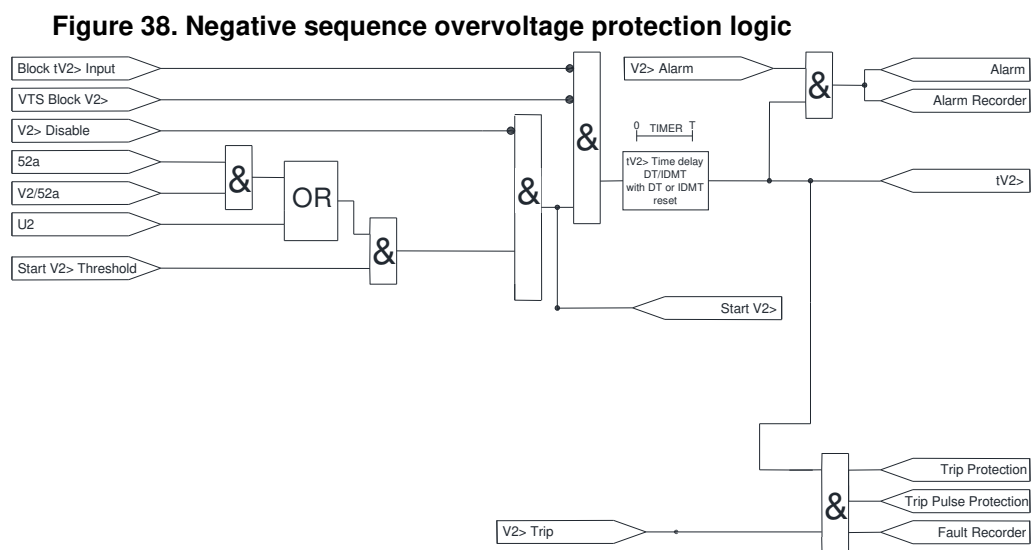

Settings

Menu Text	Authorized Values	Default Setting
V2> ?	Disabled Trip Alarm Trip/52a Alarm/52a	Disabled
V2> Threshold	5... 200 V (step: 0.1 V) 20... 720 V (step: 0.1 V)	20 V (for 57 – 130 VAC) 20 V (for 220 – 480 VAC)
V2> Delay Type	DT IEC_SI IEC_VI IEC_EI IEC_LTI UK_STI RECT RI IEEE_MI IEEE_VI IEEE_EI CO2_Px20 US_CO8 RXIDG BPN_EDF CO2_Px40	DT
tV2> /TMS/TD	0.02... 200 s (step: 0.01 s)	0.02 s
V2> Reset Delay Type	DT High State IDMT	DT High State
V2> DMT tReset	0... 600 s (step: 0.01 s)	0 s
V2>> ?	Disabled Trip Alarm Trip/52a Alarm/52a	Disabled
V2>> Threshold	5... 200 V (step: 0.1 V) 20... 720 V (step: 0.1 V)	40 V (for 57 – 130 VAC) 40 V (for 220 – 480 VAC)
tV2>>	0.02... 200 s (step: 0.01 s)	0.02 s

Additional Functions

Negative sequence overvoltage function has two independent stages. Each stage can work to trip and signal to alarm. There is a possibility to block this function from state of the connector (when state is open function is blocked) or from input.

The first negative sequence overvoltage stage can be set to definite time-delay or inverse time-delay using the IEC_SI, IEC_VI, IEC_EI, IEC_LTI, UK_STI, C02_P20, US_CO8, IEEE_MI, IEEE_VI, IEEE_EI, RXIDG, BPN EDF, RI, RECT, C02_P40 curves. Their parameters are shown in the *Overvoltage and Undervoltage Protection Tripping Curves section of this manual*.

The second stage can be set as definite time-delay only.

The instantaneous stages are labeled “V2>” for the first stage, “V2>>” for the second instantaneous stages respectively.

The time-delayed stages are labeled “tV2>” for the first stage, “tV2>>” for the second time-delayed stages respectively.

The protection elements trip when the following conditions are realized:

- A negative sequence of the voltage exceeds the set overvoltage threshold
- The relevant time-delay has elapsed
- The blocking logic (if used) is not activated.

Additional Options

By default this function is off.

Positive Sequence Undervoltage Protection

Applicable to Easergy P1V Series



Description

This function is used to help to protect motors against faulty operation due to insufficient or unbalanced network voltage, and detection of reverse rotation of motor.

The positive sequence undervoltage element included in the Easergy P1V relays provides two stage non-directional positive sequence undervoltage protection with independent time-delay characteristics. These characteristics are selectable between inverse definite minimum time (IDMT) and definite time (DT) for first stage. The second stage can operate only with DT characteristic.

If the **V1<** protection element is set to **Trip**, it means that that element is linked to the **Protect.Trip** and **Prot.Trip pulse** functions.

If the **V1<** protection element is set to **Alarm**, it means that that element is linked to the **Alarm** function.

- If **Trip** is selected, the positive sequence overvoltage stage will trip when positive sequence of voltage exceeds set threshold value.
- If **Alarm** is selected, the positive sequence overvoltage stage will indicate when positive sequence of voltage exceeds set threshold value.
- If **Trip/52a** is selected, the positive sequence overvoltage stage will trip when positive sequence of voltage exceeds set threshold value and there is a confirmation of closed state of breaker.
- If **Alarm/52a** is selected, the positive sequence overvoltage stage will indicate when positive sequence of voltage exceeds set threshold value and there is a confirmation of closed state of breaker.

Block Diagram

Figure 39. Positive sequence undervoltage protection logic

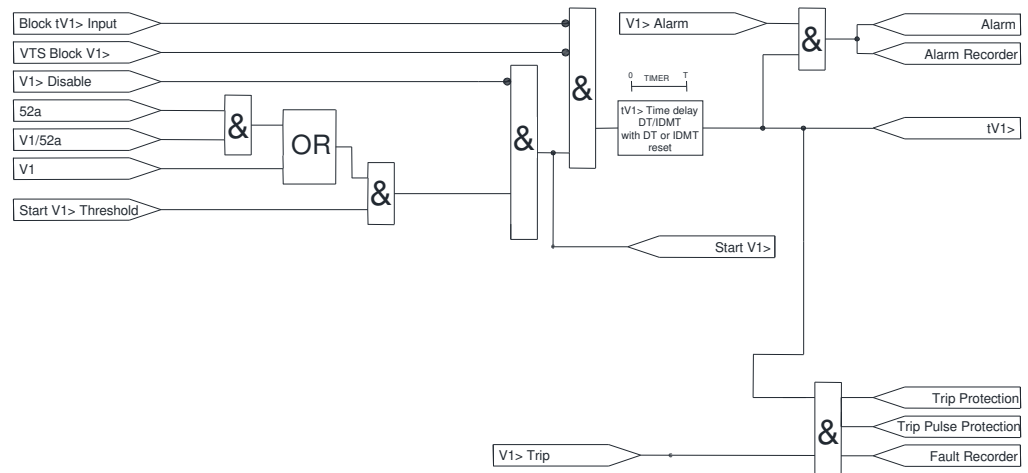

Settings

Menu Text	Authorized Values	Default Setting
V1< ?	Disabled Trip Alarm Trip/52a Alarm/52a	Disabled
V1< Threshold	5... 130 V (step: 0.1 V) 20... 480 V (step: 0.1 V)	20 V (for 57 – 130 VAC) 20 V (for 220 – 480 VAC)
V1< Delay Type	DT IEC_SI IEC_VI IEC_EI IEC_LTI UK_STI RECT RI IEEE_MI IEEE_VI IEEE_EI CO2_Px20 US_CO8 RXIDG BPN_EDF CO2_Px40	DT
tV1< /TMS/TD	0.02... 200 s (step: 0.01 s)	0.02 s
V1< Reset Delay Type	DT High State IDMT	DT High State
V1< DMT tReset	0... 600 s (step: 0.01 s)	0 s
V1<<?	Disabled Trip Alarm Trip/52a Alarm/52a	Disabled
V1<< Threshold	5... 200 V (step: 0.1 V) 20... 720 V (step: 0.1 V)	40 V (for 57 – 130 VAC) 40 V (for 220 – 480 VAC)
tV1<<	0.02... 200 s (step: 0.01 s)	0.02 s

Additional Functions

Positive sequence undervoltage function has two independent stages. Each stage can work to trip and signal to alarm. There is a possibility to block this function from state of the connector (when state is open function is blocked) or from input.

The first positive sequence undervoltage stage can be set to definite time-delay or inverse time-delay using the IEC_SI, IEC_VI, IEC_EI, IEC_LTI, UK_STI, C02_P20, US_CO8, IEEE_MI, IEEE_VI, IEEE_EI, RXIDG, BPN EDF, RI, RECT, C02_P40 curves. Their parameters are shown in the ***Overvoltage and Undervoltage Protection Tripping Curves section of this manual.***

The second stage can be set as definite time-delay only.

The instantaneous stages are labeled “V1<” for the first stage, “V1<<” for the second instantaneous stages respectively.

The time-delayed stages are labeled “tV1<” for the first stage, “tV1<<” for the second time-delayed stages respectively.

The protection elements trip when the following conditions are realized:

- A positive sequence of the voltage exceeds the set undervoltage threshold
- The relevant time-delay has elapsed
- The blocking logic (if used) is not activated.

The first stage [V1</tV1<] has a reset timer.

The value that is set for this reset timer corresponds to the minimum time during which the voltage value needs to be higher than 102% of threshold before the corresponding phase time-delay is reset.

NOTE: This rule does not apply when the protection element is triggered. When the protection element is triggered, the time-delay $tV1<$ is immediately reset.

All other information about undervoltage functions are similar to u/v function.

Additional Options

By default this function is off

Frequency Protection (81O/81U)

Applicable to Easergy P1V Series



Description

The frequency protection function has two possibilities of operation: underfrequency and overfrequency.

Underfrequency is used to detect abnormal, low frequency conditions in comparison to the rated frequency, while overfrequency option can detect abnormal, higher frequency conditions.

The frequency element included in the Easergy P1V relay provides six stages of non-directional overfrequency or underfrequency protection with independent time-delay characteristics.

These characteristics are only definite time (DT) characteristic.

If the $f>$ (or $f<$) protection element is set to **Trip**, it means that that element is linked to the **Protect.Trip** and **Prot.Trip pulse** functions (see **LED and Output configuration**).

If the f protection element is set to **Alarm**, it means that that element is linked to the **Alarm** function (see **LED and Output configuration**).

- If $f>$ **Trip** is selected, the frequency stage will work in overfrequency option and trip when frequency exceeds set threshold value.
- If $f>$ **Alarm** is selected, the frequency stage will work in overfrequency option and indicate alarm when frequency exceeds set threshold value.
- If $f<$ **Trip** is selected, the frequency stage will work in underfrequency option and trip when frequency exceeds set threshold value.
- If $f<$ **Alarm** is selected, the frequency stage will work in underfrequency option and indicate alarm when frequency exceeds set threshold value.

Block Diagram

Figure 40. Block diagram of Frequency Protection (81O/81U) function

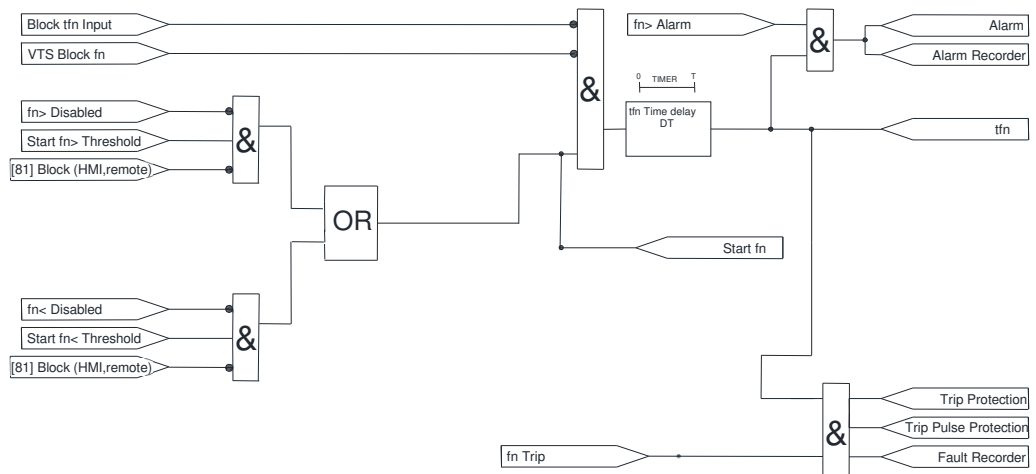

Settings

Menu Text	Authorized Values	Default Setting
f1 ? f2 ? f3 ? f4 ? f5 ? f6 ?	Disabled f> Trip f> Alarm f< Trip f< Alarm	Disabled
f1 Threshold f2 Threshold f3 Threshold f4 Threshold f5 Threshold f6 Threshold	40... 60 Hz (step: 0.01 Hz) @50 Hz 50... 70 Hz (step: 0.01 Hz) @60 Hz	50 Hz
tf1 tf2 tf3 tf4 tf5 tf6	0.1... 600 s (step: 0.01 s)	0.1 s

Additional Functions

Underfrequency protection (A)

Frequency variations on a power system are an indication that the power balance between generation and load has been lost. In particular, under-frequency implies that the net load is in excess of the available generation. Such a condition can arise, when an interconnected system splits, and the load left connected to one of the subsystems is in excess of the capacity of the generators in that particular subsystem. Industrial plants that are dependent on utilities to supply part of their loads will experience under-frequency conditions when the incoming lines are lost.

An underfrequency condition at nominal voltage can result in over-fluxing of generators and transformers and many types of industrial loads have limited tolerances on the operating frequency and running speeds e.g. synchronous motors. Sustained underfrequency has implications on the stability of the system, whereby any subsequent disturbance may lead to damage to frequency sensitive equipment and even blackouts, if the underfrequency condition is not corrected sufficiently fast.

The underfrequency protection settings are found in the

SETTING GROUP x/PROTECTION Gx / [810/81U] FREQUENCY/f?/f< trip/alarm.

Setting guidelines

In order to minimize the effects of underfrequency on a system, a multi stage load shedding scheme may be used with the plant loads prioritized and grouped. During an underfrequency condition, the load groups are disconnected sequentially depending on the level of underfrequency, with the highest priority group being the last one to be disconnected.

The effectiveness of each stage of load shedding depends on what proportion of the power deficiency it represents. If the load shedding stage is too small compared to the prevailing generation deficiency, then the improvement in frequency may be non-existent. This aspect should be taken into account when forming the load groups.

Time delays should be sufficient to override any transient dips in frequency, as well as to provide time for the frequency controls in the system to respond. This should be balanced against the system survival requirement since excessive time delays may jeopardize system stability. Time delay settings of 5 - 20s are typical.

The relatively long time delays are intended to provide time for the system controls to respond and will work well in a situation where the decline of system frequency is slow. For situations where rapid decline of frequency is expected, the load shedding scheme above should be supplemented by rate of change of frequency protection elements.

Overfrequency protection (A)

Overfrequency running of a generator arises when the mechanical power input to the machine exceeds the electrical output. This could happen, for instance, when there is a sudden loss of load due to tripping of an outgoing feeder from the plant to a load center.

Under such overspeed conditions, the operator should respond quickly so as to obtain a balance between the mechanical input and electrical output, thereby restoring nominal frequency. Overfrequency protection is required as a back-up to cater for slow response of frequency control equipment.

The underfrequency protection settings are found in the

SETTING GROUP x/PROTECTION Gx /[810/81U] FREQUENCY/fx/f< trip/alarm.

Setting guidelines

Following faults on the network, or other operational requirements, it is possible that various subsystems will be formed within the power network and it is likely that each of these subsystems will suffer from a generation to load imbalance. The “islands” where generation exceeds the existing load will be subject to over frequency conditions, the level of frequency being a function of the percentage of excess generation. Severe over frequency conditions may be unacceptable to many industrial loads, since running speeds of motors will be affected.

Additional Options

By default function is off.

Circuit Breaker Control

Applicable to Easergy P1V Series

L	N	A
---	---	---

Description

The P1V relays includes the following options for control of a single circuit breaker:

- Local tripping and closing, via the function keys
- Local tripping and closing, via the relay menu (N, A)
- Local tripping and closing, via relay binary inputs (A)
- Remote tripping and closing, using the relay communications (N, A)

Operation

A manual trip will be permitted provided that the circuit breaker is initially closed. Likewise, a close command can only be issued if the CB is initially open. To confirm these states, it will be necessary to use the breaker 52A (assigned to **CB status 52A** input (N, A)) and/or 52B (assigned to **CB status 52B** input (N, A)) contacts. Under these circumstances manual CB control will be possible.

Once a CB Close command is initiated the output contact (**Close CB order**) can be set to operate following a user-defined time-delay (**Time delay for Close** setting in **GLOBAL SETTINGS/CIRCUIT BREAKER** menu). This would give personnel time to move away from the circuit breaker following the close command. This time-delay will apply to all manual CB Close commands.

The length of the trip or close control pulse can be set via the **tOpen Pulse min** and **tClose Pulse** settings respectively (**GLOBAL SETTINGS/CIRCUIT BREAKER** menu). These should be set long enough to help to ensure the breaker has completed its open or close cycle before the pulse has elapsed.

Note: The manual trip and close commands are found in the default Control cell (N, A) and the Close/Trip keys on the front panel.

If an attempt to close the breaker is being made, and a protection trip signal is generated, the protection trip command overrides the close command.

If **CB FLT Ext.Sign.** (A) is assigned to a binary input this signal is checked before manual closing of the CB. This function uses the signal received at the relay's binary input to confirm whether the breaker is capable of closing (sufficient circuit breaker energy for example). A user-settable time-delay, **tCB FLT Ext.Sign.** (A), is included for manual closure. If, following a close command, the CB does not signal a healthy condition before that timer elapses, then the relay will lockout and issue an alarm.

Connection of Output RL1: Circuit Breaker Tripping

Shunt trip coil

Figure 41. Shunt trip coil application

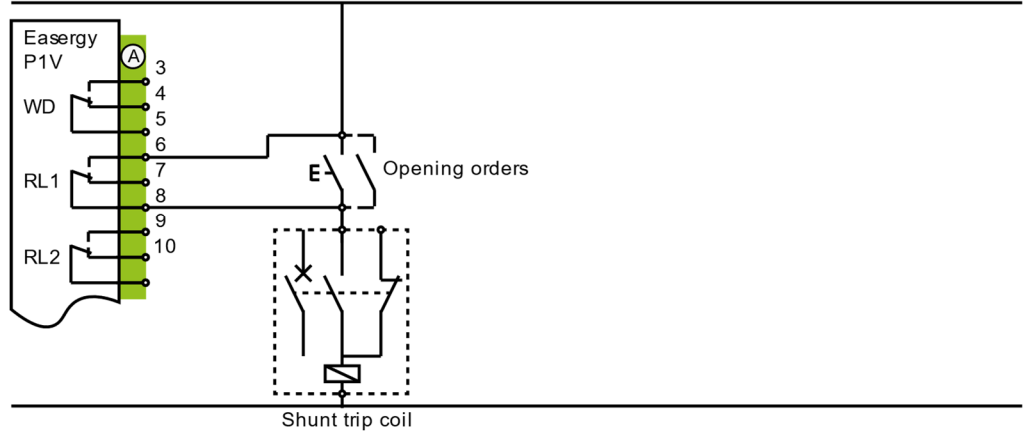

If Easergy P1V detects a fault, closing of the output relay RL1 normally open contact trips opening of the circuit breaker by supplying power to the shunt trip coil. This contact stays closed after the circuit breaker trips, until the fault is acknowledged.

Undervoltage trip coil

Figure 42. Undervoltage trip coil application

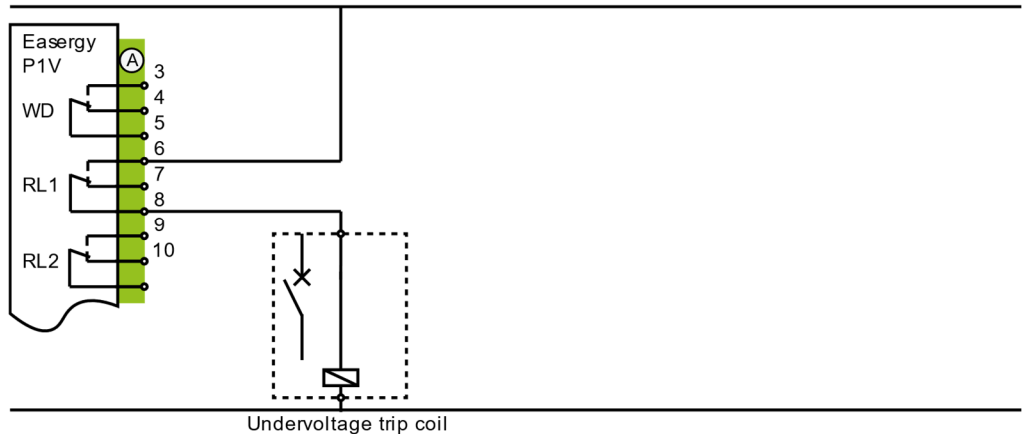

In this case, it is necessary to invert the control logic for output relay RL1. The normally open contact will be kept in the closed position continuously, until a fault appears. If P1V detects a fault, opening of the contact trips opening of the circuit breaker by opening the undervoltage trip coil power supply circuit. This contact stays open after the circuit breaker trips, until the fault is acknowledged.

Connection of Output RL2: Trip Lockout (ANSI 86 Function)

Figure 43. Trip Lockout diagram

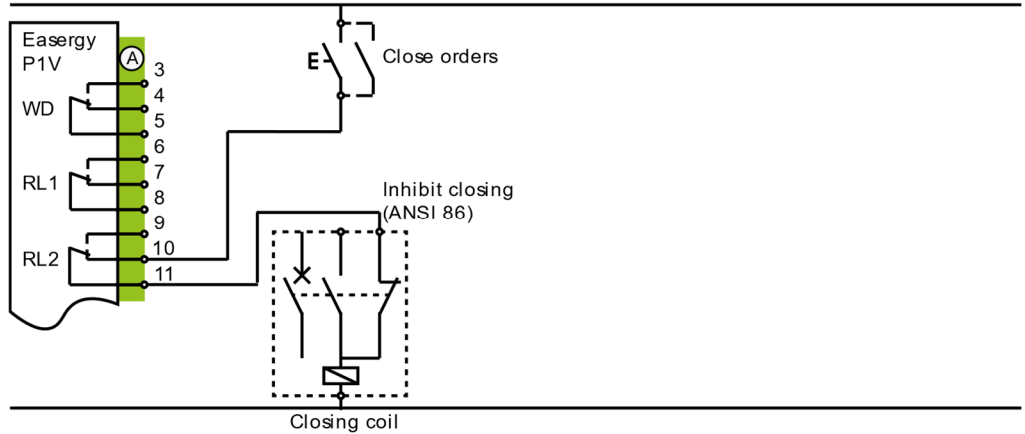

If P1V detects a fault, opening of the RL2 output relay normally closed contact cuts the closing coil power supply circuit. This contact stays open after the trip order, until the fault is acknowledged. In this state, all close orders are inhibited.

Additional Functions

By default, this function is off.

Settings for Using the Function

Circuit breaker (Circuit breaker control settings)	Authorized Values	Default Setting
tOpen Pulse min	0.10... 10.00 s (step: 0.01 s)	0.10 s
tClose Pulse	0.10... 10.00 s (step: 0.01 s)	0.10 s
Time Delay for Close	0.01... 200.0 s (step: 0.01 s)	0.00 s
tCB FLT Ext.Sign.	1.00... 200.0 s (step: 1.00 s)	16 s

External Trip (Auxiliary timers)

Applicable to Easergy P1V Series

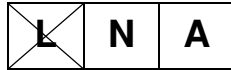

Description

Using a binary input, Easergy P1V relays can be used to take account of a trip order issued by an external protection device.

For example, specific protection devices for power transformers (Buchholz, gas-pressure-temperature detectors, etc.) can be hard-wired on an Easergy P1V binary input to trip the circuit breaker.

The external devices can be hard-wired directly into the circuit breaker trip circuit, but there are three advantages in connecting a Easergy P1V binary input:

- External trip orders will be memorized by the ANSI 86 function, integrated in the Easergy P1V unit. Trip lockout will apply until the fault is acknowledged.
- The trip order and its origin will be indicated on the Easergy P1V front panel. The trip will be saved and time tagged in the log of the last 20 faults.
- The circuit breaker trip circuit is simplified, and hence more reliable.

Block Diagram

Figure 44. Operating principle diagram for external trip (auxiliary timers)

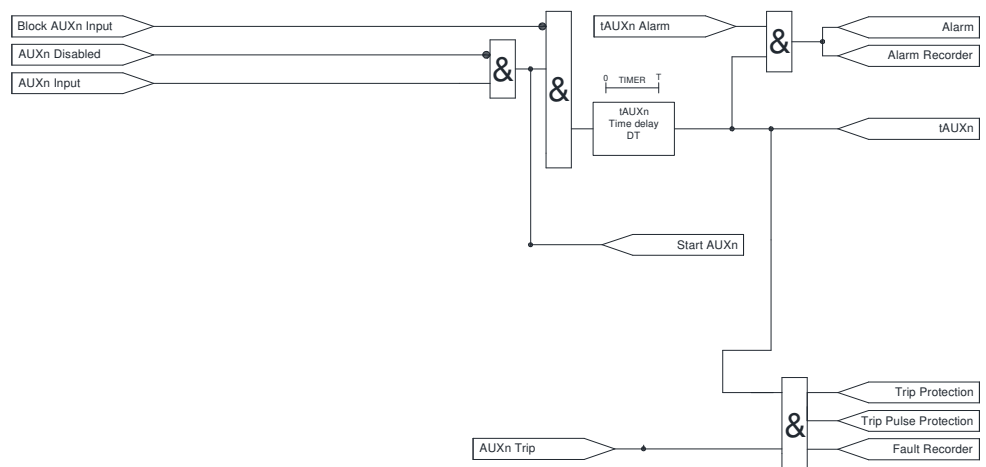

Standard Operation

Two (N) and three (A) auxiliary timers, tAux1, tAux2, tAux3 are available and associated with logic inputs Aux1, Aux2, Aux3 (refer to the **SETTING GROUP x/INPUTS CONFIGURATION** menu). When these inputs are energized, the associated timers start and, when the set time has elapsed, the associated LEDs (**SETTING GROUP x/LEDs CONFIGURATION Gx** menu) are lit or/and the associated output relays close (refer to the **SETTING GROUP x/OUTPUT RELAYS CONFIGURATION Gx** menu). Time-delays can be independently set from 0 ms to 600 s.

Each auxiliary timer can be set independently to:

- **Trip:** Protection Trip signal
- **Alarm:** Alarm signal

In the **SETTING GROUP x/INPUTS CONFIGURATION Gx (A)** menu **AUX4** and **AUX5** can be mapped to inputs. These input functions have no timers (instantaneous action). They can be used as bridges between inputs and LEDs or inputs and outputs. It is not possible to link this input function to a **Trip** or **Alarm** signal.

Additional Functions

By default, this function is off.

Settings for Using the Function

SETTING GROUP x/PROTECTION Gx/AUX TIMERS Gx screen:

Aux timers	Authorized Values	Default Setting
AUX1	Disabled, Trip, Alarm	Disabled
tAUX1	0.00... 600.00 s (step: 0.01 s)	0.00 s
AUX2	Disabled, Trip, Alarm	Disabled
tAUX2	0.00... 600.00 s (step: 0.01 s)	0.00 s
AUX3 (A)	Disabled, Trip, Alarm	Disabled
tAUX3	0.00... 600.00 s (step: 0.01 s)	0.00 s

Logic Discrimination (ANSI 68)

Applicable to Easergy P1V Series

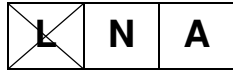

All Easergy P1V relays can send a logic discrimination blocking order.

Only Easergy P1V model **N, A** relays can receive a logic discrimination blocking order.

Description

The logic discrimination function can achieve a significant reduction in tripping times for circuit breakers located right next to the source. It can mitigate the disadvantages of the conventional time discrimination process.

This function exploits the hard-wiring of a logic data item between the protection functions, making it possible to block the protection upstream by protection functions located downstream. With logic discrimination, the protection settings should be fixed in relation to the element to be protected without worrying about the discrimination aspect.

Block Diagram

Figure 1. Operating principles diagram for logic discrimination

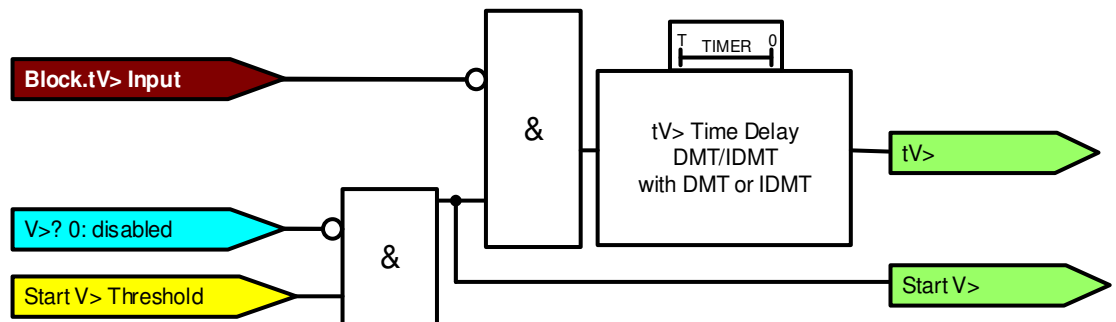

P0931ENb

Standard Operation

Each stage of the protection element can be blocked via an appropriately configured binary input. Binary inputs can be assigned to the following functions (**SETTING GROUPx/INPUT CONFIGURATION Gx**):

- Block.tV>, (**N, A**)
- Block.tV>>, (**N, A**)
- Block.tV>>>, (**N, A**)
- Block.tV<, (**N, A**)
- Block.tV<<, (**N, A**)
- Block.tV<<<, (**N, A**)
- Block.tV1<, (**A**)
- Block.tV1<<, (**A**)
- Block.tV2>, (**N, A**)

- Block.tv2>>, (N, A)
- Block.tvN>, (N, A)
- Block.tvN>>, (N, A)
- Block.tvN>>>, (N, A)
- Block.tf1, (A)
- Block.tf2, (A)
- Block.tf3, (A)
- Block.tf4, (A)
- Block.tf5, (A)
- Block.tf6, (A)

Such a configured input can be used by the blocking logic function or by a protection element disabling function (AUX).

The logic discrimination function can be applied to radial feeder circuits where there is little or no back feed. For parallel feeders, ring circuits or where there can be a back feed from generators, directional relays should be considered.

The logic discrimination function allows the upstream IDMT relay to be blocked by the start output of a downstream relay that has detected the presence of a fault voltage above its threshold. Thus both upstream and downstream relays can have the same voltage and time settings, and the blocking feature will automatically provide grading.

Additional Functions

By default, this function is off.

Operating Language

Applicable to Easergy P1V Series

L	N	A
---	---	---

Description

The default language is English.

Settings

Selection of the operating language can be accessed in the parameter's menu. The parameter to be set is **GLOBAL SETTINGS/LOC/LANGUAGE** screen.

For ordering options: REL15024, REL15025, REL15026, REL15027, REL15028, REL15029, REL15030, REL15031, REL15032, REL15033.

GLOBAL SETTINGS/LOC/Language menu cell

Language	Authorized Values	Default Setting
Language	English, German French Spanish Russian Turkish	English

For ordering options: REL15024R, REL15028R, REL15032R,

GLOBAL SETTINGS/LOC/Language menu cell

Language	Authorized Values	Default Setting
Language	English, German French Spanish Russian Turkish	English

Date and Time

Applicable to Easergy P1V Series

L	N	A
---	---	---

Description

Easergy P1V has an internal clock which can be used to assign a date and time:

- To events recorded by the time-tagged record of the last 200 events function
- To other time-tagged events (Fault recorder), which can be accessed via the communication

If the relay is powered from auxiliary voltage then the internal clock is maintained from this voltage. In the event of failure of the Easergy P1V auxiliary power supply, the internal clock is maintained by a backup capacitor. If the backup capacitor will be discharged (approx. after 72hours without voltage), the internal clock will reset itself to 01/01/2015 00:00:00.

NOTE: Operation of the protection functions is not affected by the charged or discharged of the backup capacitor.

Settings

The date and time setting can be accessed in the **OP PARAMETERS** menu.

The parameters to be set are:

- Date setting (**Current date** menu cell)
- Time setting (**Current time** menu cell)

The date and time setting in the parameter's menu is not considered when the Easergy P1V date and time are synchronized via the communication.

Password

Applicable to Easergy P1V Series

L	N	A
---	---	---

Description

The password protection of the relay comprises three levels:

- **Configurator** (Administrator) - all the menu settings may be changed. On this password level all programmable LEDs (from 3 up to 7 LEDs) sequential flashing.
- **Operator** (Protection setting) - it is possible to change settings in the **PROTECTION** column; **CTRL Default Windows (CB status CTRL, LR mode CTRL, [81] CTRL)** and **COMMISSIONING/Maintenance Mode** windows are also possible. On this password level all programmable LEDs (from 3 up to 7 LEDs) sequential flashing.
- **User** (Control only) – this level is used for tests and/or control execution only (no changing of setting parameters) so signaling of **SETTING CHANGE MODE** differs from above. On this password level all programmable LEDs (from 3 up to 7 LEDs) flashing in the same time.

All password levels are additionally signaled by the special sign: , which informs that change settings or controls (depend on password level) are allowed.

For each level the password consists of 4 digits (0 to 9)

NOTE: The default password for each password level:

1. **Configurator – 0002**
2. **Operator – 0001**
3. **User – 0000 or 9999**

It is recommended to change default passwords from 0000, 0001, 0002, 9999 to unique value for every password level.

If the first password is different, this means that the *Configurator* password has been changed.

The *Operator* password is still 0001. Therefore, to help to protect settings against unauthorized access it is necessary to change the *Protection setting* password by first entering 0000 then a new value.

The *User* password is still 0000 (or 9999). Therefore, if it is necessary to change it, first enter 0000 then the new value (*User right*) of the password.

- Notes:
1. If the *Operator* rights have not been changed, or if it has been set to the (0000), it is possible to change all the settings in the **PROTECTION** column, reset the counters and control the CB without entering a password, simply by pressing the **OK** navigation key. This makes it possible to change a chosen parameter by automatically switching the P1V to the **SETTING CHANGE MODE** (the programmable LEDs are flashing). This means that even after changing only one parameter it is necessary to switch the P1V back to **PROTECTION MODE** in order to activate the new settings (warm restart).

2. If the *Control* rights password has not been changed or if it has been set to (0000) it is possible to control the CB in menu without password protection.

Additional Functions

SETTING CHANGE MODE

The **SETTING CHANGE MODE** should be used to change settings.

Using the **SETTING CHANGE MODE** helps to ensure that all changed parameters will be applied simultaneously so as to avoid any problems caused by possible setting inconsistencies.

The **SETTING CHANGE MODE** makes it possible to change settings while the relay is active without any risk (the P1V continues to use the previous settings).

After exiting the **SETTING CHANGE MODE**, a warm reset of firmware is applied so that all the protection counters are reset.

Note: Latched LEDs and outputs are reset (stored values are cleared during a P1V reset).

To switch the P1V to the **SETTING CHANGE MODE** navigate to the **SETTING CHANGE MODE** main header, then press the  key:





```
Edit settings?
Enter PSWD
```

Press the  navigation key.

```
Edit settings?
Enter PSWD 0000
```

The 0 digit furthest to the right is flashing.

Enter the password:

1. If the digit is flashing, change the digit to the required value by pressing the  key or the  key.
2. Change the flashing digit by pressing the  key or  key.
3. Continue as above to set the whole password (4 digits)
4. If the correct password is set, press the  navigation key

The LCD displays 'OK' during approximately 1 second, then the new **SETTING CHANGE** cell is displayed:

If the password entered is for:

- *Configurator* rights:

```
Setting change:
Configurator
```

To indicate that the P1V is in **SETTING CHANGE MODE** on the level: **Configurator** the programmable LEDs are sequential flashing

- *Operator* settings:

```
Setting change:
Operator
```

To indicate that the P1V is in **SETTING CHANGE MODE** on the level: **Operator** the programmable LEDs are sequential flashing

- User only:

**Setting change:
User**

To indicate that the P1V is in **SETTING CHANGE MODE** on the level: **User** the programmable LEDs are flashing (all LEDs in the same time). **User** mode is active by 5 minutes only (since the last menu activity). After this time the relays automatically leaves this mode.

The screen displays the scope of the current modification rights.

At this time, it is possible to start changing the setting parameters.

Note: The parallel pressing: ◀ and ▲ keys it makes jump from any place to:

**Edit settings?
Enter PSWD**

the menu cell in which the password can be entered (hot keys).

If all settings are changed, it is necessary to return to **PROTECTION MODE** to apply a warm reset.

Press the ◀ and ▲ keys simultaneously to jump to the following cell:

**Edit settings?
Exit:press ENTER**

Press the OK navigation key to apply a warm reset and display the following cell:

**Setting change:
Protected**

The programmable LEDs stop flashing. The P1V is in **PROTECTION MODE**.

Note: In **SETTING CHANGE MODE** all functions use the previously stored settings (before the **SETTING CHANGE MODE** was entered).

Changing of a single setting parameter

- Go to the required setting cell.

- Press the HMI OK key:

**Edit settings?
Enter PSWD 0000**

Enter the password and then press OK navigation key to confirm the password and switch to **SETTING CHANGE MODE**.

- Press OK navigation key to enter the chosen setting parameter.

- Set the required value.

- Confirm the change by pressing the OK navigation key.

- Switch from **SETTING CHANGE MODE** to **PROTECTION MODE**.

Changing the password

To change the password, first enter the existing password to obtain the appropriate password protection rights.

Press the  key to display the following cell:

Edit Password

Press the  navigation key, to display:

Edit Password
0000

Enter the new password.

Press  navigation key to confirm the new password and jump to the cell displaying information on protection rights.

Switch from **SETTING CHANGE MODE** to **PROTECTION MODE**. After this the settings are password-protected and the P1V is in **PROTECTION MODE**. Additionally the programmable LEDs stop flashing.

Watchdog Relay

Applicable to Easergy P1V Series

L	N	A
---	---	---

Description

Easergy P1V

Easergy P1V relays are equipped as standard with a watchdog relay (WD, terminal numbers A3-A4-A5, see Installation chapter). This is a changeover relay output which is kept permanently in the on-position (A3 – A5) by Easergy P1V. In the event of Easergy P1 failure, or if the auxiliary power supply fails, the watchdog relay reverts to the off-position.

Circuit Breaker Status Monitoring

Applicable to Easergy P1V Series

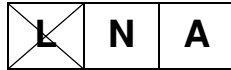

Description

CB positions can be selected at **SETTING GROUP x/INPUTS CONFIGURATION Gx**:

- *status CB 52A*
- *status CB 52B*

If two inputs are assigned to both the above inputs, CB status is based on both indications.

If only one function is used, CB status is based on a single-bit information only (the second is derived from the first one).

The CB status is indicated on the LCD display in control menu cell as follows:

CB status: 52Ad CTRL: Do nothing

CB status is used by various protection and monitoring functions (e.g. auto-reclose, open time etc.) for proper operation.

Example

To binary input 1 is assigned status CB 52A and AUX1

To binary input 2 is assigned status CB 52B and AUX2

To LED 7 is assigned to AUX1

To LED 8 is assigned to AUX2

In the above configuration LED7 indicates the CB closed position and LED8 indicates the CB open position.

Circuit Breaker Supervision

Applicable to Easergy P1V Series

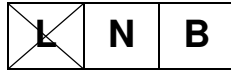

Description

Periodic maintenance of circuit breakers is generally based on a fixed time interval, or a fixed number of fault voltage interruptions, thus Easergy P1V relays record controls and statistics related to each circuit breaker trip or close operation allowing proper maintenance and operation of substation equipment.

Standard Operation

The relays record the following controls and statistics related to each circuit breaker trip or close operation:

- monitoring time for CB opening (triggered by the **Trip CB order** and **Protect.Trip** outputs). Operations based on the setting
 - time-delay setting for tripping (**GLOBAL SETTINGS/CIRCUIT BREAKER/Max CB Open Time**)

If CB opening time is longer than **Max CB Open Time** the Alarm is issued (**Alarm CB Time Monit.**). This function can be activated in the menu: **GLOBAL SETTINGS/CIRCUIT BREAKER/ CB Supervision? 1: Yes,**
- monitoring time for CB closing (triggered by the **Close CB order** output). Operations based on the setting:
 - time-delay setting for closing (**GLOBAL SETTINGS/CIRCUIT BREAKER/Max CB Close Time**)

If CB closing time is longer than **Max CB Close Time** the Alarm is issued (**Alarm CB Time Monit.**). This function can be activated in the menu: **GLOBAL SETTINGS/CIRCUIT BREAKER/ CB Supervision: 1: Yes,**
- CB open operations counter (triggered by **Trip CB order**: HMI, Manual Trip Logic Input, HMI, open control key, rear communication trip command, USB port (N, A) trip command)
 - Number of open operations (**RECORDS/COUNTERS/CONTROL COUNTER/No.Trips**)
- CB close operations counter (triggered by **Close CB order**: HMI, Manual Close Logic Input, HMI 'Close' key, rear communication close command, USB port (N, A) close command)
 - Number of close operations (**RECORDS/COUNTERS/CONTROL COUNTER/No. Close**)
- protection CB open operations counter (triggered by **Protect Trip, Prot.Tr pulse** output)
 - Number of CB open operations (**RECORDS/COUNTERS/FAULT COUNTER/No. Fault Trips**)

CB Alarm output function and **CB Alarm** LEDs function signal is generated if **CB Supervision** function detects any problem.

Cause of Alarm	Alarm function	Key setting	Alarm Label	Output	LED
----------------	----------------	-------------	-------------	--------	-----

The monitoring time for CB opening	CB Supervision	Max CB Open Time	CB Time Monit.	CB Alarm	CB Alarm
The monitoring time for CB closing	CB Supervision	Max CB Close Time	CB Time Monit.	CB Alarm	CB Alarm
The abnormal CB's position for two bits CB's connection (00 or 11)	CB Supervision	value: Max CB Close Time or Max CB Open Time	State of CB	CB Alarm	CB Alarm

Settings

Menu Text	Authorized Values	Default Setting
CB Supervision?	Yes No	No
Max.CB Open Time	0.50... 10.00 s (step: 0.01 s)	0.1 s
Max.CB Close Time	0.50... 10.00 s (step: 0.01 s)	0.5 s

Local / Remote Mode

Applicable to Easergy P1V Series

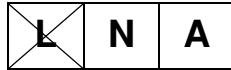

Description

The Local / Remote Mode function is to make possible blocking commands sent remotely through communication networks (such as setting parameters, control commands, etc.), to help to prevent any accidents or maloperation during maintenance work performed on site.

Standard Operation

Easergy P1 can be operated in three modes: “Remote” (A), “Local” (N, A) and “L+R” (local and remote, N, A) depending on the user selected settings.

Below description concerning Easergy P1V model A only. Description for model N is included in the section Additional Function of this subchapter. Main setting (A) is available at **GLOBAL SETTINGS/ CIRCUIT BREAKER/Remote CTRL Mode**:

0: Remote only – remote control is permitted only. All manual controls (HMI, Close/Trip function keys, Binary Inputs assigned to Manual Close or Trip) are blocked.

In **Remote only** mode the menu default control mode cell looks as follow:

```
LR Stat.: Remote
CTRL: Remote
```

Remote only status means that remote control via RS485/USB is possible only (local control is rejected by Easergy P1V).

This control mode can be changed (the second line (CTRL) of menu cell) from **Remote** to **Local** and inversely.

To change from **Remote** to **Local** mode it is necessary to press the **OK** button, enter Control Password (if set), press **OK** button (confirm password – if set; and select changing). Press down or up button to choose **Local** and confirm with **OK** button. After applying above procedure the menu cell looks as follow:

```
LR Stat.: Local
CTRL: Local
```

Local status means that local control is possible only. Remote commands via RS485/USB are rejected by Easergy P1V (except the synchronizing time signal, **CTRL: Remote** or **CTRL: Local, Comms. Order** commands).

With Local/Remote control mode functionality the digital input label “**Local CTRL mode**” can be associated. When this signal is assigned to any digital input then Local/remote control mode gets following functionality:

- With **Local CTRL Mode** binary input energized the menu cell looks as follow:

```
LR Stat.: Local
```

LR Stat.: Local status means that only local control is possible. It is not possible to change the control mode from the HMI.

- With **Local CTRL Mode** binary input deenergized the menu cell looks as follow:

LR Stat.: Remote

LR Stat.: Remote status means that remote control commands can be issued. It is not possible to change the control mode from the HMI.

1: Remote + Local – remote and local control permitted.

In **Remote + Local** mode the menu default control mode cell looks as follow:

LR Stat.: L+R
CTRL: Remote

Remote only status means that both the local (HMI, control buttons on the front panel, binary inputs) and remote control (RS485/USB) is possible.

This control mode can be changed (the second line (**CTRL**) of menu cell) from **L+R** to **Local** and inversely.

LR Stat.: Local
CTRL: Local

Local status means that local control is possible only.

With Local/Remote control mode functionality the digital input label “**Local CTRL mode**“ can be associated. When this signal is assigned to any digital input then Local/remote control mode gets following functionality:

- With **Local CTRL Mode** binary input energized the menu cell looks as follow:

LR Stat.: Local

LR Stat.: Local status means that only local control is possible. It is not possible to change the control mode from the HMI.

- With **Local CTRL Mode** binary input deenergized the menu cell looks as follow:

LR Stat.: Remote

LR Stat.: Remote status means that remote control commands can be issued. It is not possible to change the control mode from the HMI.

Additional Functions

Below description concerning Easergy P1V model **N** only.

Default control mode cell looks as follow:

LR mode: L+R
CTRL: Remote

L+R status means that both the local (HMI, control buttons on the front panel) and remote control (RS485/USB) is possible.

This control mode can be changed (the second line (**CTRL**) of menu cell) from **L+R** to **Local** and inversely.

LR Stat.: Local
CTRL: Local

Local status means that local control is possible only.

Settings

Local / remote parameters can be selected at **GLOBAL SETTING /CIRCUIT BRAKER/ Remote CTRL Mode:**

Menu Text (A)	Authorized Values	Default Setting
Remote CTRL Mode	0: Remote only 1: Remote+LOC	0: Remote only

Setting Group Selection

Applicable to Easergy P1V Series

L	N	A
---	---	---

Description

Easergy P1 relays have two protection setting groups called **PROTECTION G1** and **PROTECTION G2**. Only one group is active at a time.

Standard Operation

If a group is used in an application it is not possible to remove the other group from the menu. If one group only is chosen the relay uses Group 1 even if the other parameters are set to Group 2 (Inputs(N, A), Menu, Remote Group Setting).

Switching between groups can be done via:

- the selected binary input (N, A) assigned to the **Setting Group 2** logic input (**SETTING GROUP x/INPUTS CONFIGURATION Gx** submenu)
- the relay front panel interface (**GLOBAL SETTINGS/SETTING GROUP SELECT/ Setting Group: 1: Group1 or 2: Group2**),
- through the communications port (refer to the Mapping Database for detailed information).

Switching between setting groups can be done even while a protection function is active, but it resets all timers, LEDs on P1V front panel).

The user can check which one of the setting groups is active in the menu **OP PARAMETERS/Active Set Group** cell.

The user can also assign the active group (**Setting Group x** function) to an output relay (**SETTING GROUP x/OUTPUT RELAYS CONFIGURATION Gx**) or to an LED (**SETTING GROUP x/LEDs CONFIGURATION G1**).

Setting group change via a digital input

It is possible to change the setting group by energizing a digital input (N, A) (operates on level: logic input is low – setting group 1, logic input is high – setting group 2).

If the setting group switchover is done via a binary input (N, A), the change from Group 1 to Group 2 is executed after the set time-delay: **t Change Setting G1 ->G2** (**GLOBAL SETTINGS/SETTING GROUP SELECT**) (N, A). The switching from Group 2 back to Group 1 is instantaneous.

NOTE: If the digital input that has been assigned to the setting group change operates on level (low or high), it is not possible to change the setting group via remote communications.

Switching between Active Groups via a Binary Input (N, A)

When powering up the relay, the selected group (Group 1 or Group 2) corresponds to the state of the logic input assigned to **Setting Group 2**. This means:

A – Reverse Inp.Logic = 0 and Setting Group 2 = 1
(**SETTING GROUP x/INPUTS CONFIGURATION Gx** submenu).

If the programmed logic input starts being supplied with +V, then after the **t Change Setting G1->G2** time-delay the active group will be G2. If the programmed logic input is not supplied with +V, the active group will be G1.

B – Reverse Inp.Logic = 1 and Setting Group 2 = 1
(**SETTING GROUP x/INPUTS CONFIGURATION Gx** submenu).

If the programmed logic input is supplied with +V, then the active group will be G1. If the programmed logic input stops being supplied with +V, then after the **t Change Setting G1->G2** time-delay the active group will be G2.

NOTES:

- Binary Input configuration is associated with both Setting Groups, so that if in a Setting Group the selected binary input is assigned to **Setting Group 2**, in the other group it must be set to **Setting Group 2** as well, otherwise no switch will occur.
- If the Easergy P1V is powering up (from or the auxiliary voltage) and Group 2 is selected via a binary input, the **t Change Setting G1->G2** time-delay is ignored (changing to setting group 2 is instantaneous – without time-delay).
- The setting group switch is based on the level of the binary input. So as long as Setting Group 2's logic signal is high, the Easergy P1V uses Setting Group 2.

If the programmed logic input is supplied with +V, then the active group will be G1. If the programmed logic input stops being supplied with +V, then after the **t Change Setting G1->G2** time-delay the active group will be G2.

Switch between Active Groups via the Menu or a Remote Command (RS485, USB)

By using the relay front panel interface it is possible to change the active setting group:

1: Group 1 or 2: Group 2 (menu cell: **GLOBAL SETTINGS/SETTING GROUP SELECT/ Setting Group**).

This menu cell is commonly used for switching groups from the front panel interface and via a remote command (RS485 or USB).

It means that if the **GLOBAL SETTINGS/SETTING GROUP SELECT/ Setting Group** menu cell is set to **1: Group 1** and the remote setting group 2 command is executed, the value of menu cell: **GLOBAL SETTINGS/SETTING GROUP SELECT/ Setting Group** will be changed to **2: Group 2** (Active group: 2).

Setting group 1 will be applied if:

- **1: Group 1** is set in the **GLOBAL SETTINGS/SETTING GROUP SELECT/ Setting Group** menu cell from the relay's front panel interface,
- *the remote setting group 1 command is executed. The value of the **GLOBAL SETTINGS/SETTING GROUP SELECT/ Setting Group** menu cell will then be changed to **1: Group 1***

Priority

NOTE: If the digital input that has been assigned to the setting group change operates on level (low or high), it is not possible to change the setting group via neither remote communications nor the front panel.

The detailed logic table for setting group selection is shown below:

Binary Input Setting Group 2 (L, N, A)	Front Panel and Remote Setting	Active Group
Not configured	G1	G1
Not configured	G2	G2
G1	G1	G1
G1	G2	G1
G2	G1	G2
G2	G2	G2

NOTE: If a setting group change initiated by a remote command has not been effected due of priority settings, that command is ignored (not recorded in the P1V's logic for the future, when priority settings allow changing).

It is possible to assign an Active Group state to an output contact by setting the output contact to the **Setting Group x** output (**SETTING GROUP x/OUTPUT RELAYS CONFIGURATION Gx**).

If Active Group signaling is required, some LEDs should be assigned to the **Setting Group x** function (**SETTING GROUP x/LEDs CONFIGURATION Gx**).

Settings

Setting group select parameters can be selected at **GLOBAL SETTINGS/SETTING GROUP SELECT**:

Menu Text	Authorized Values	Default Setting
Setting Group	Group 1 Group 2	Group 1
t Change Settings G1→G2 (N, A)	0.00 to 200 s, (step 0.01 s)	0.00 s
Copy Settings	No Operation Copy G1→G2 Copy G2→G1	No Operation

Commissioning Mode

Applicable to Easergy P1V relays



Description

Commissioning Mode in Easergy P1V relays has three modes: **Maintenance mode**, **Output tests** and **Functional test**, amongst which the last two are available only if **Maintenance mode** is active.

Maintenance Mode

Maintenance mode menu allows the user to check the operation of the protection functions.

It is possible to set following **Maintenance mode** options (settings):

- **No** - maintenance mode is disabled. All window cells below are hidden (**Maintenance mode** is the latest cell in **COMMISSIONING** column).
- **Yes** - maintenance mode is enabled. In this mode all test cells in **COMMISSIONING** column are shown. During the tests outputs are energized (control of outputs are not blocked).
- **Yes – BI.Out.** - maintenance mode is enabled and all test cells in **COMMISSIONING** column are shown. In this mode, the high state of output functions are ignored (control of outputs are blocked)

This option allows the user to check the operation of the protection functions without actually sending any external command (Tripping or signaling).

Independently on the rear protocol selected in menu (Modbus RTU or IEC 60870-5 -103), transmission of information to SCADA is active with additional information to know that Easergy P1V is in Maintenance mode (refer to Communication chapter and IEC 60870-5-103 standard).

Changing of setting from **No** to **Yes** or **Yes – BI.Out.** from the front panel activate this mode for 10 minutes only. After this time setting is automatically switched to **No**.

The selection of the maintenance mode is possible by logic input (the level), control command (rear or front port), or by front panel HMI. The maintenance mode is terminated by:

- Low state of logic input assigned to **Maintenance mode** function.
- Control command which activate this mode (rear command or setting: **Yes**, **Yes – BI.Out.**) and by turning off the power supply.

NOTE: Maintenance rear command is available in Modbus protocol only.

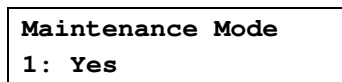

It is possible to assign the state of **Maintenance mode** to programmable LEDs.

In **Yes – BI.Out.** case, all the output contacts are blocked, and no command can be issued to these contacts, even if a protection threshold associated with one of these output contacts has been crossed. (If a protection threshold is crossed, all associated LEDs will be ON, even the TRIP LED, if protection element is set to **Trip**).

If the input assigned **to Maintenance mode** is logical high the Maintenance Mode is active (without any time limitation) up to low state of the logical input.

Outputs Test

This function is available after activation of **Maintenance mode** – setting **Yes**.

The commissioning cells allow the user to check the external wiring to the relay's output contacts. To do this, the user has only to set to 1 the desired output contact's corresponding bit, and this will close the contact and allow the continuity of the wiring to be checked.

Test	7654321
Pattern	0000000

In the cell below, the contact test time can be set:

Contact Test	
Time	1.00s

If the outputs for test are selected and Time for output closing is set, the closing command can be executed in this cell:

Test output	
0: no operation	

To execute the test, press **OK** key, select **1: Apply test** and confirm action by **OK**. The contact will be closed for the duration of the **Contact Test Time** pulse.

Functional Test

This function is available after activation of **Maintenance mode**.

This functionality is used to check the functional outputs of the Easergy P1V. To do this, the user has only to select which protection element will be triggered, and this will close the contact assigned to this protection element and allow the continuity of the wiring to be checked. If the protection element is disabled there will be no action.

Functional Test	
0: v>	

In the cell below the end of the functional test can be configured:

Functional Test	
End 0: CBtrip	

The following options are possible:

- **0: CB trip** – after triggering the functional test, the test is interrupted after trip command.
- **1: Time** – the protection element will be triggered for the duration of the pulse time.

If the **1: Time** option is selected it is necessary to set the pulse length:

Functional Test	
Time	01.00s

The next cell is used for functional test execution:

Functional Test	
0: no operation	

To execute this test, press the **OK** key, select **1: Operate** and confirm action by pressing **OK**. The contact will be closed for the duration of the **Functional Test Time** pulse.

NOTE: In **Maintenance mode** Easergy P1V works with full functionality (ready to trip in a fault condition, even during functional test). During functional test of selected stage (for example tV>), P1V measures voltages so the rest active stages (for example tV>>, tVN>, etc) work on the measured voltage from the field. Only the tested stage (for example tV>) sees test voltage: two times greater than tV> voltage setting value in all phases. After test, in the fault record all recorded voltage values are based on the voltage measured in the field.

If Functional Test will be applied for protection element which is disabled there will be no any action done.

Real Time Clock Synchronization via Opto-Inputs

Applicable to Easergy P1V relays



Description

In modern protective schemes it is often desirable to synchronize the relay’s real time clock so that events from different relays can be placed in chronological order. This can be done using the communication interface connected to the substation control system or via a binary input.

Any of the available binary inputs on the Easergy P1V relay can be selected for synchronization. Pulsing this input will result in the real time clock snapping to the nearest minute.

Recommended pulse duration is 20 ms, repeated no more than once per minute.

Standard Operation

The example of time synchronization function is shown in table below:

Time of “Sync. Pulse”	Corrected Time
19:47:00.000 to 19:47:29.999	19:47:00.000
19:47:30.000 to 19:47:59.999	19:48:00.000

NOTE: The above assumes a time format of hh:mm:ss

The input is configured in the **SETTING GROUP x/INPUTS CONFIGURATION Gx** menu. The input must be assigned to the **Time Synchr.** input.

Resetting of Trip Info, Alarms Info, Latched LEDs and Outputs

Applicable to Easergy P1V relays

L	N	A
----------	----------	----------

Description

The way or resetting the latched LEDs and outputs is determined by the inputs assigned to the resetting of latched LED. Outputs can be reset via external inputs, by pressing the R clear key on the Easergy P1V's front panel if the LCD shows the default display or via the communication port.

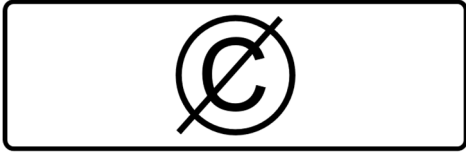
NOTICE
<p>Resetting of LEDs and relay outputs is impossible if reason of the triggering and/or tripping any protections or functions still exist (e.g. trip signal occurred, but CB is closed and voltage still has ben present on analog inputs of the relay).</p> <p>In this case if R button was pushed on the relay LCD is displayed following window:</p> <div style="text-align: center; margin: 10px 0;">  </div> <p>It is mean that reset of the LEDs and outputs in this moment is impossible.</p>

Standard Operation

The resetting configuration can be entered in the **GLOBAL SETTINGS/LOC** menu:

- **LEDs Reset:**
 - **0: Manual only** (via Inputs, HMI (R key), Remote Reset command)
 - **1: Start protect.** (Start of a protection element set to Trip)
 - **2: Close Command** (Resetting of latched LEDs upon Close Command applied by Easergy P1V)
- **Ltchd Outp.Reset:**
 - **0: Manual only** (via Inputs, HMI (R key), Remote Reset command)
 - **1: Protect.Start** (Start of a protection element set to Trip)
 - **2: Close Command** (Resetting of latched LEDs upon Close Command applied by Easergy P1V)
- **Trip Info Reset:**
 - **0: Manual only** (via Inputs, HMI (R key), Remote Reset command)
 - **1: Protect.Start** (Start of a protection element set to Trip)
 - **2: Close Command** (Resetting of latched LEDs upon Close Command applied by Easergy P1V)
- **Alarms Info Ltch.:**
 - **0: Self Reset** – This option means that if an alarm signal has disappeared no information is available in the **ALARM STATUS** column

- **1: Manual Reset** – this option means that if an alarm signal has disappeared information is still available in the **ALARM STATUS** column until it is reset in the **ALARM STATUS/Alarm Reset** cell.

The **Manual only** option helps to prevent a close command from being issued without readout of the cause of trip by maintenance personnel. It reduces the risk to switch on to fault.

The **Start protect** and **Protect.Start** options allows to signal the latest trip only: Start of any protection element set to trip the CB, reset all latched LEDs and show the default display.

Settings

Resetting method of latched LEDs can be selected at **GLOBAL SETTINGS/LOC**:

Menu Text	Authorized Values	Default Setting
LEDs Reset	Manual only Start protect. Close command	Manual only
Ltchd Outp.Reset	Manual only Protect.Start Close command	Manual only
Trip Info Reset	Manual only Protect.Start Close command	Manual only
Alarms Info Ltch	Self Reset Manual Reset	Self Reset

Fault and Alarm Records

Applicable to Easergy P1V relays

L	N	A
---	---	---

Description

The specified, for each type of Easergy P1V series, data is recorded for any relevant elements that operated during a fault or an alarm. The recorded data can be viewed in each of the last 20 fault records for fault elements and 5 records for alarm elements.

Standard Operation

Each fault and alarm record is generated with time stamp.

Both fault and alarm records are stored in non-volatile memory (FRAM memory). This type of memory does not require any maintenance (no battery inside the Easergy P1V is required). Fault records are stored without any time limitation even if the Easergy P1V is not supplied from any power source.

- **Fault records**

The following data is recorded for any relevant elements that operated during a fault, and can be viewed in each of the last 20 fault records:

- Event Text (the reason for a trip):

V> trip
 V>> trip
 V>>> trip
 V< trip
 V<< trip
 V<<< trip
 VN> trip
 VN>> trip
 VN>>> trip
 V2> trip (N, A)
 V2>> trip (N, A)
 V1< trip (A)
 V1<< trip (A)
 f1 trip (A)
 f2 trip (A)
 f3 trip (A)
 f4 trip (A)
 f5 trip (A)
 f6 trip (A)
 AUX1 trip (N, A)
 AUX2 trip (N, A)
 AUX3 trip (A)

- Active setting Group
- Fault Time an Fault Date
- Fault Origin: type of fault (for example: phase A-B, A-B-C, etc.)

- Event Value:

Per phase record of the voltage value during the fault and VN.

- **Alarm records**

The following data is recorded for any relevant elements that operated during an alarm, and can be viewed in each of the last 5 alarm records:

- Event Text (the reason for a protection alarm):

V> alarm

V>> alarm

V>>> alarm

V< alarm

V<< alarm

V<<< alarm

VN> alarm

VN>> alarm

VN>>> alarm

V2> alarm (N, A)

V2>> alarm (N, A)

V1< alarm (A)

V1<< alarm (A)

f1 alarm (A)

f2 alarm (A)

f3 alarm (A)

f4 alarm (A)

f5 alarm (A)

f6 alarm (A)

AUX1 alarm (N, A)

AUX2 alarm (N, A)

AUX3 alarm (A)

- Active setting Group
- Alarm Time an Alarm Date
- Alarm Origin: type of alarm (for example: phase A-B, A-B-C, etc.)
- Event Value:

Per phase record of the voltage value during the fault and VN.

Alarm Status

Applicable to Easergy P1 Series

L	N	A
---	---	---

Description

The Alarm status function presents the current Alarm signals.

Standard Operation

The Alarm signals information can be realized with latching or without latching, depending on the **GLOBAL SETTINGS/LOC/Alarms Info** value:

- **0:Self-reset** – only current Alarm status is displayed,
- **1:Manual Reset** – Alarm information is latched up, to reset via cell **ALARM STATUS/Reset** Press OK button.

The following Alarm statuses can be displayed:

Time of “Sync. Pulse”	Corrected Time
tV> Alarm	Alarm by the first phase overvoltage stage
tV>> Alarm	Alarm by the second phase overvoltage stage
tV>>> Alarm	Alarm by the third phase overvoltage stage
tV< Alarm	Alarm by the first phase undervoltage stage
tV<< Alarm	Alarm by the second phase undervoltage stage
tV<<< Alarm	Alarm by the third phase undervoltage stage
tVN> Alarm	Alarm by the first earth fault overvoltage stage
tVN>> Alarm	Alarm by the second earth fault overvoltage stage
tVN>>> Alarm	Alarm by the third earth fault overvoltage stage
tV2> Alarm (N, A)	Alarm by the first negative sequence overvoltage stage
tV2>> Alarm (N, A)	Alarm by the second negative sequence overvoltage stage
tV1< Alarm (A)	Alarm by the first positive sequence undervoltage stage
tV1<< Alarm (A)	Alarm by the second positive sequence undervoltage stage
tf1 Alarm (A)	Alarm by the first frequency protection stage
tf2 Alarm (A)	Alarm by the second frequency protection stage
tf3 Alarm (A)	Alarm by the third frequency protection stage
tf4 Alarm (A)	Alarm by the fourth frequency protection stage
tf5 Alarm (A)	Alarm by the fifth frequency protection stage
tf6 Alarm (A)	Alarm by the sixth frequency protection stage
CB Time Monit. Alarm. (A)	The monitoring time for CB opening/closing
Hardw.Warning Alarm	Any hardware problem detected
State of CB Alarm (A)	The abnormal CB's position for two bits CB's connection (00 or 11)
tAUX2 Alarm (N, A)	tAUX2 time-delay elapsed
tAUX3 Alarm (A)	tAUX3 time-delay elapsed
tCB FLTY Ext.Sign. Alarm (A)	An input mapped to this function detects CB problems that may influence control possibilities (for example spring problem, insufficient pressure, etc.)

Event Records

Applicable to Easergy P1V relays

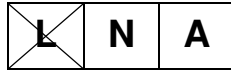

Description

The Easergy P1V relay records and time tags up to 200 events and stores them in non-volatile FRAM memory. This enables the system operator to establish the sequence of events that occurred within the relay following a particular power system condition, switching sequence etc. When the available space is exhausted, the oldest event is automatically overwritten by the most recent one.

The real time clock within the relay provides the time tag for each event, with a resolution of 1 ms.

The event records are available for remote viewing, via the communications ports RS485 or USB.

For extraction from a remote source via communications ports, refer to the SCADA Communications section where the procedure is fully explained.

Standard Operation

Any event may be a change of state of a control input or output relay, a trip condition, etc.

The following sections show the various items that constitute as an event:

- **Change of state of binary inputs (N, A)**

If one or more of the binary inputs has changed state since the last time that the protection algorithm ran, the new status is logged as an event. The information is available if the event is extracted and viewed via a PC.

- **Change of state of one or more output relay contacts**

If one or more of the output relay contacts have changed state since the last time that the protection algorithm ran, then the new status is logged as an event. The information is available if the event is extracted and viewed via PC.

- **Relay alarm conditions**

Any alarm conditions generated by the relays will also be logged as individual events. The following table shows examples of some of the alarm conditions and how they appear in the event list:

Alarm Condition	Event Text	Event Value
Auxiliary Supply Fail	Vx Fail ON/OFF	Bit position 0 in 32 bit field

The above table shows the abbreviated description that is given to the various alarm conditions and also a corresponding value between 0 and 31. This value is appended to each alarm. It is used by the event extraction software, such as eSetup, to identify the alarm. Either ON or OFF is shown after the description to signify whether the particular condition is operational or has reset.

- **Protection element trips**

Any operation of protection elements (a trip condition) will be logged as an event record, consisting of a text string indicating the operated element and an event value. Again, this value is intended for use by the event extraction software, such as eSetup Easergy Pro.

Measurements and Related Settings

Applicable to Easergy P1V Relays

L	N	A
---	---	---

Description

For the convenience of an operator and substation maintenance process the Easergy P1V relay produces a variety of directly measured power system quantities.

Standard Operation

The directly measured power system quantities available in Easergy P1V relay are listed below:

Va, Vb, Vc	- fundamental harmonic values,
Vab, Vbc, Vca	- fundamental harmonic values,
VN (L, N, A)	- calculated neutral voltage (fundamental harmonic values)
VN (N, A)	- measured neutral voltage (fundamental harmonic values)
V1 (A)	- calculated positive sequence of voltage,
V2 (N, A)	- calculated negative sequence of voltage
f (A)	- frequency,

NOTE: All the measured voltage values depends on the VT Ratio setting (**GLOBAL SETTINGS/VT RATIO**). The typical deviations of measurements for phase and earth voltages is $\pm 2\%$ at Vs (setting value) and $\pm 2\%$ at Ves (setting value).

Standard Operation

The following settings under the measurements heading can be used to configure the relay measurement function:

- VT Ratio setting – responsible for line and earth voltages transformer input's primary and secondary voltage ratings, can be found in: **GLOBAL SETTINGS/VT RATIO** menu.
- Default Measuring Window – displayed after connection of power supply to Easergy P1 or after resetting of signaling, can be found in: **GLOBAL SETTINGS/LOC** menu.
- Sets type of analog connection of VT. Can be found in: **GLOBAL SETTINGS/VT Ratio/VTs Connection** menu.
- Sets type of voltage which is use in protections Can be found in: **GLOBAL SETTINGS/VT Ratio/Prot. Config. V>** and **GLOBAL SETTINGS/VT Ratio/Prot. Config. V<** menu.

Counters

Applicable to Easergy P1V Relays

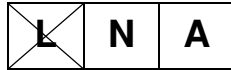

Description

The Easergy P1V's counters gather information on the vast number of various events during relay operation, e.g.: manual trip commands, trip commands from protection elements, hardware problems detected by the self-monitoring function, auto-recloser starts, etc.

Standard Operation

The Easergy P1V's counters are available in the **RECORDS/COUNTERS** menu:

- **CONTROL COUNTER:**
 - **No. Trips** – number of manual trip commands (inputs, menu default control window, control key, remote control via RS485 or USB).
 - **No. Close** - Number of manual close commands (inputs, menu default Control Window, control key, remote control via RS485 or USB).

Counters can be reset in the **CONTROL COUNTER** column – **Counter Reset** cell.

- **FAULT COUNTER:**
 - **No. Fault Trips** – number of trip commands from protection elements (voltage based protection element trip, AUX trips).
 - **No. Fault Starts** – Number of timer starts by protection elements set to trip (voltage based protection element and AUX).
 - **No. Alarms** - number of Alarm signals from protection elements set to Alarm or functions mapped to an Alarm signal.
 - **No. HW Warnings** – Number of hardware problems detected by the self-monitoring function.

Counters can be reset in the **FAULT COUNTER** column – **Counter Reset** cell.

Disturbance Records

Applicable to Easergy P1V Relays



Description

The Easergy P1V's integral disturbance recorder has an area of memory specifically set aside for record storage. The number of records that may be stored by the relay is dependent upon the selected recording duration.

Standard Operation

The total number of records available in Easergy P1V's disturbance recorder is:

- 1 – for set **Max Record Time** in range of: 2.01 s – 4.00 s
- 2 – for set **Max Record Time** in range of: 1.51 s – 2.00 s
- 3 – for set **Max Record Time** in range of: 1.01 s – 1.33 s
- 4 – for set **Max Record Time** in range of: 0.81 s – 1.00 s
- 5 – for set **Max Record Time** in range of: 0.10 s – 0.80 s

NOTE: Maximum recording time is 4 s.

NOTE: The maximum number of records is 5.

The recorder stores actual samples that are taken at a rate of 16 samples per cycle. The recording is in COMTRADE format. Each disturbance record consists of four analog data channels and fifteen digital data channels. The relevant VT ratio for the analog channels are also extracted to enable scaling to primary quantities.

NOTE: If a VT ratio is set to less than a unit, the relay will choose a scaling factor of zero for the appropriate channel.

Settings

The **GLOBAL SETTINGS/DISTURBANCE RECORDER** menu column is shown in the following table:

Menu Text	Authorized Values	Default Setting
Pre-Time	0.1... 2.00 s (step: 0.01 s)	0.10 s
Post-Fault Time	0.1... 1.00 s (step: 0.01 s)	0.10 s
Disturb.Rec.Trig.	0: on Inst. 1: on Trip	0: on Inst.
Max Record Time	0.1... 4.00 s (step: 0.01 s)	1.5 s

It is not possible to display the disturbance records locally on the LCD; they must be extracted using suitable software such as eSetup Easergy Pro.

Communication

Introduction

Applicable to Easergy P1V Series

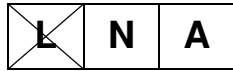

Purpose of this document

This document describes the characteristics of the different communication protocol of Easergy P1V relay.

The available communication protocols of Easergy P1V relay are as follows:

- MODBUS.
- IEC 60870-5-103.

NOTE:

This document shows all available functions in P1V. To see which function are available in model refer to the rest chapters/sections of this manual.

For example: disturbance recorder is available in model A only, etc.

Glossary

VA, VB, VC	: voltage measured on the concerned phases (A, B, C)
VN	: residual voltage measured by earth input or calculated as vector sum
pf	: soft weight of a word of 16 bits
PF	: heavy weight of a word of 16 bits.

Modbus Protocol

Easergy P1V relay can communicate by a RS 485 link behind the unit following the MODBUS MODICON RTU protocol.

In Easergy P1V the status of the rear communication port is signaled by flashing rectangles in the top and bottom right corners of the display. Tx (Transmit) is assigned to the top right corner, Rx (Receive) is assigned to the bottom right corner of the display. Flashing of the rectangles indicate the operation of the communication port only (not frames received and/or transmitted).

TECHNICAL CHARACTERISTICS OF THE MODBUS CONNECTION

Parameters of the MODBUS Connection

The different parameters of the MODBUS connection are as follows:

- Isolated two-point RS485 connection (2kV 50Hz),
- MODBUS MODICON line protocol in RTU mode
- Communication speed can be configured by an operator dialog in the front panel of the relay:

Baud rate
4800
9600
38400
57600
115200

Transmission mode of the configured characters by operator dialog:

Mode
1 start / 8 bits / 1 stop: total 10 bits
1 start / 8 bits / even parity / 1 stop: total 11 bits
1 start / 8 bits / odd parity / 1 stop: total 11 bits
1 start / 8 bits / 2 stops: total 11 bits

Synchronization of Exchanges Messages

All character received after a silence on the line with more or equal to a transmission time of 3 characters is considered as a firm start.

Message Validity Check

The frame validity is working with a cyclical redundancy code CRC with 16 bits. The generator polynomial is:

$$1 + x^2 + x^{15} + x^{16} = 1010\ 0000\ 0000\ 0001\ \text{binary} = A001h$$

Address of the Easergy P1 relays

The address of the Easergy P1V relay on a same MODBUS network is situated between 1 and 247. The address 0 is reserved for the broadcast messages.

MODBUS Functions of the Easergy P1V Relays

The MODBUS functions implemented on the Easergy P1V relays are:

- Function 3 or 4: Reading of n words
- Function 5: Writing of 1 bit
- Function 6: Writing of 1 word
- Function 7: Fast reading of 8 bits
- Function 16: Writing of n words

Presentation of the MODBUS Protocol

Master slave protocol, all exchange understands a master query and a slave response

Frame size received from Easergy P1V relay

Frame transmitted by the master (query):

Slave number	Function code	Information	CRC16
1 byte	1 byte	n bytes	2 bytes
0 to F7h	3h, 4h, 5h, 6h, 7h, 10h, 2Bh		

Slave number:

The slave number is situated between 1 and 247.

A frame transmitted with a slave number 0 is globally addressed to all pieces of equipment (broadcast frame)

Function code:

Requested MODBUS function (1 to 16)

Information:

Contains the parameters of the selected function.

CRC16:

Value of the CRC16 calculated by the master.

Note: The Easergy P1V relay does not respond to globally broadcast frames sent out by the master.

Format of Frames Sent by the Easergy P1V Relay

Frame sent by the Easergy P1V relay (response)

Slave number	Function code	Data	CRC16
1 byte	1 byte	n bytes	2 bytes

0 to F7h	3h, 4h, 5h, 6h, 7h, 10h, 2Bh		
----------	------------------------------	--	--

Slave number:

The slave number is situated between 1 and 247.

Function code:

Processed MODBUS function (1 to 16).

Data:

Contains reply data to master query.

CRC 16:

Value of the CRC 16 calculated by the slave.

Messages Validity Check

When Easergy P1V relay receive a master query, it validates the frame:

- If the CRC is false, the frame is invalid. Easergy P1V relay do not reply to the query. The master must retransmit its query. Excepting a broadcast message, this is the only case of non-reply by Easergy P1V relay to a master query.
- If the CRC is good but the Easergy P1V relay cannot process the query, it sends an exception response.

Warning frame sent by the Easergy P1V relay (response)

Slave number	Function code	Warning code	CRC16
1 byte	1 byte	1 byte	2 bytes
1 to F7h	81h, 83h, 85h, 86h, 87h, 8Ah, 8Fh, ABh		pf ... PF

Slave number:

The slave number is situated between 1 and 247.

Function code:

The function code returned by the Easergy P1V relay in the warning frame is the code in which the most significant bit (b7) is forced to 1.

Warning code:

On the 8 warning codes of the MODBUS protocol, the Easergy P1V relay manages two of them:

- code 01: function code unauthorized or unknown.
- code 03: a value in the data field is unauthorized (incorrect data).

Control of pages being read

Control of pages being written

Control of addresses in pages

Length of request messages

CRC16:

Value of the CRC16 calculated by the slave.

EASERGY P1V RELAY DATABASE ORGANIZATION

Description of the Application Mapping

Settings

Easergy P1V application mapping has 9 pages of parameters.

Page 0h: Product information, remote signaling, measurements

Page 1h: General remote parameters

Page 2h: Setting group 1 remote parameters

Page 3h: Setting group 2 remote parameters

Page 4h: Remote controls

Pages 5h/6h: Reserved pages

Pages 7h: Quick reading byte

Pages 8h: Time synchronization

Disturbance Records

Before uploading any disturbance record, a service request must be sent to select the record number to be uploaded.

The answer following this request contains the following information:

- Numbers of samples (pre and post time)
- Phase/Line VT ratio
- Earth VT ratio
- Internal phase and earth ratios
- Number of the last disturbance mapping page
- Number of samples in this last disturbance mapping page

The mapping pages used for this service request are from 38h to 3Ch.

Pages 9h to 21h: Contain the disturbance data (25 pages)

A disturbance mapping page contains 250 words:

0900 to 09FAh: 250 disturbance data words

0A00 to 0AFAh: 250 disturbance data words

0B00 to 0BFAh: 250 disturbance data words

.....

2100 to 21FAh: 250 disturbance data words

The disturbance data pages contain the sample of a single channel from a record.

Page 22h: contains the index of the disturbance

Page 38h to 3Ch: Selection of the disturbance record and channel

Page 3Dh: A dedicated request allows to know the number of disturbance records stored in FRAM memory.

Event records

To upload the event records two requests are allowed:

Page 35h: Request to upload an event record without acknowledge of this event.

Used addresses:

3500h: EVENT 1

.....

35C8h: EVENT 200

Page 36h: Request to upload the non-acknowledged oldest stored event record.

Two modes are available for the acknowledgement: automatic acknowledgement or manual acknowledgement.

The mode depends of the state of bit 12 of telecommand word (address 400 h).

If this bit is set, then the acknowledgement is manual else the acknowledgement is automatic.

In automatic mode, the reading of the event acknowledges the event.

In manual mode, it is necessary to write a specific command to acknowledge the oldest event

(set the bit 13 of control word 400 h).

Fault records

Page 37h: Page dedicated to upload fault record

Used addresses:

3700h: FAULT 1

3701h: FAULT 2

.....

3714h: FAULT 20

Page 3Eh: Request to upload the non-acknowledged oldest stored fault record.

Two modes are available for the acknowledgement: automatic acknowledgement or manual acknowledgement.

The mode depends of the state of bit 12 of telecommand word (address 400 h).

If this bit is set, then the acknowledgement is manual else the acknowledgement is automatic.

In automatic mode, the reading of the fault acknowledges automatically the event.

In manual mode, it is necessary to write a specific command to acknowledge the oldest fault

(set the bit 14 of control word 400 h).

Characteristics

Page 0h can only be read through communication.

Pages 1h, 2h, 3h and 4h can be read and written.

Page 7h can be access in quick reading only.

Page 8h can be write.

They are described more precisely in the following chapters.

Page 0h: Product Information, Remote Signaling, Measurements

Read access only

Address	Group	Description	Values range	Step	Unit	Format	Default Value
0000	Product Information	Relay description characters 1 and 2	32-127		-	F10	P1
0001		Relay description characters 3 and 4	32-127		-	F10	V
0002		Relay description characters 5 and 6	32-127		-	F10	
0003		Unit reference characters 1 and 2	32-127		-	F10	SE
0004		Unit reference characters 3 and 4	32-127		-	F10	
0005		Software Version	10 to 99		-	F15	
0006		Hardware Version	0 to 4		-	F58	
0007		Line VT Sec	0 to 1		-	F21	
0008		E/Gnd VT Sec	0 to 1		-	F23	
0009		Active Set Group	0 to 1		-	F32	0
000A		Nominal frequency	0 to 1		-	F57	0
000B - 000F		Reserved			-		
0010	Remote signalling	Logical inputs status	0 to 15	1	bits	F11	
0011		Voltage Protection disable status (1)	0 to 15	1	bits	F12	
0012		Protection Function disable status (2)	0 to 15	1	bits	F12A	
0013		Output contacts status	0 to 15	1	bits	F24	
0014		Logical LEDs status	0 to 15	1	bits	F25	
0015		Voltage Protection starting status (1)	0 to 15	1	bits	F28	
0016		Protection Fuction starting status (2)	0 to 15	1	bits	F28A	
0017		Voltage Protection trip status (1)	0 to 15	1	bits	F29	
0018		Protection Fuction trip status (2)	0 to 15	1	bits	F29A	
0019		Voltage Protection Alarm status 1	0 to 15	1	bits	F31	
001A		Protection Fuction Alarm status 2	0 to 15	1	bits	F31A	
001B		CB status	0 to 4	1	-	F30	
001C		Reserved					
001D		Reserved					
001E		Local/Romote Mode Status	0 to 2	1	-	F61	
001F		Maintance Mode	0 to 2	1	-	F62	

Address	Group	Description	Values range	Step	Unit	Format	Default Value
0020		Hardware Warning	0 to 15	1	-	F26	
0021		Output information: V>	0 to 15	1	bits	F37	
0022		Output information: V>>	0 to 15	1	bits	F37	
0023		Output information: V>>>	0 to 15	1	bits	F37	
0024		Output information: V<	0 to 15	1	bits	F37	
0025		Output information: V<<	0 to 15	1	bits	F37	
0026		Output information: V<<<	0 to 15	1	bits	F37	
0027		Output information: VN>	0 to 15	1	bits	F50	
0028		Output information: VN>>	0 to 15	1	bits	F50	
0029		Output information: VN>>>	0 to 15	1	bits	F50	
002A		Output information: V2>	0 to 15	1	bits	F50	
002B		Output information: V2>>	0 to 15	1	bits	F50	
002C		Output information: V1<	0 to 15	1	bits	F50	
002D		Output information: V1<<	0 to 15	1	bits	F50	
002E		Output information: AUX1	0 to 15	1	bits	F50	
002F		Output information: AUX2	0 to 15	1	bits	F50	
0030		Output information: AUX3	0 to 15	1	bits	F50	
0031		Reserved					
0032		Output information: tf1	0 to 15	1	bits	F50	
0033		Output information: tf2	0 to 15	1	bits	F50	
0034		Output information: tf3	0 to 15	1	bits	F50	
0035		Output information: tf4	0 to 15	1	bits	F50	
0036		Output information: tf5	0 to 15	1	bits	F50	
0037		Output information: tf6	0 to 15	1	bits	F50	
0038 - 003F		Reserved					
0040	Remote measurements	Phase VA (L1) voltage [V]	0 to 65535	1	[V]/10	F1	
0041		Phase VB (L2) voltage [V]	0 to 65535	1	[V]/10	F1	
0042		Phase VC (L3) voltage [V]	0 to 65535	1	[V]/10	F1	
0043		Phase VAB (L1-L2) voltage [V]	0 to 65535	1	[V]/10	F1	
0044		Phase VBC (L2-L3) voltage [V]	0 to 65535	1	[V]/10	F1	
0045		Phase UCA (L3-L1) voltage [V]	0 to 65535	1	[V]/10	F1	
0046		E/F VN (UE) measured voltage [V]	0 to 65535	1	[V]/10	F1	
0047		E/F 3U ₀ derived voltage [V]	0 to 65535	1	[V]/10	F1	
0048		V1 positive sequence voltage [V]	0 to 65535	1	[V]/10	F1	
0049		V2 negative seq. voltage [V]	0 to 65535	1	[V]/10	F1	
004A		Frequency	0 to 65535	1	[Hz]/100	F1	
004B		Reserved					
004C		E/F for default display	0 to 65535	1	[V]/10	F1	
004D		Delta Vr	0 to 65535	1	[V]/10	F1	

Address	Group	Description	Values range	Step	Unit	Format	Default Value
004E - 004F		Reserved					
0050		Phase VA (L1) voltage [Un]	0 to 65535	1	[Un]/1000	F1	
0051		Phase VB (L2) voltage [Un]	0 to 65535	1	[Un]/1000	F1	
0052		Phase VC (L3) voltage [Un]	0 to 65535	1	[Un]/1000	F1	
0053		Phase VAB (L1-L2) voltage [Un]	0 to 65535	1	[Un]/1000	F1	
0054		Phase VBC (L2-L3) voltage [Un]	0 to 65535	1	[Un]/1000	F1	
0055		Phase VAB (L3-L1) voltage [Un]	0 to 65535	1	[Un]/1000	F1	
0056		E/F VN (UE) measured voltage [Un]	0 to 65535	1	[Un]/1000	F1	
0057		E/F 3U ₀ derived voltage [Un]	0 to 65535	1	[Un]/1000	F1	
0058		V1 positive sequence voltage [Un]	0 to 65535	1	[Un]/1000	F1	
0059		V2 negative seq. voltage [Un]	0 to 65535	1	[Un]/1000	F1	
005A		Reserved					
005B		Reserved					
005C		E/F for default display	0 to 65535	1	[Un]/1000	F1	
005D - 007F		Reserved					
0080		Max Va	0 to 65535	1	[Un]/1000	F1	
0081		Max Vb	0 to 65535	1	[Un]/1000	F1	
0082		Max Vc	0 to 65535	1	[Un]/1000	F1	
0083		Max Vab	0 to 65535	1	[Un]/1000	F1	
0084		Max Vbc	0 to 65535	1	[Un]/1000	F1	
0085		Max Vca	0 to 65535	1	[Un]/1000	F1	
0086 - 00FF		Reserved					

Page 1h, Easergy P1V: General Remote Parameters

Read and write access

Address	Group	Description	Values range	Step	Unit	Format	Default Value
0100	Remote parameters	Address	1 to 127	1	-	F1	1
0101		Protocol for RS485	0 to 1	1		F56	0
0102		Baud Rate	0 to 5	1		F19	2
0103		Parity	0 to 2	1		F20	0
0104		Stop bits	0 to 1	1		F22	0
0105-010F		Reserved					
0110	Counters	Trips Number	0 to 65535	1	-	F1	0
0111		Close Number	0 to 65535	1	-	F1	0
0112		Fault Trips Number	0 to 65535	1	-	F1	0
0113		Fault Start Number	0 to 65535	1	-	F1	0
0114		Alarm Number	0 to 65535	1	-	F1	0
0115		HW Warnings Number	0 to 65535	1	-	F1	0
0116		CB close Monitoring	0 to 65535	1	-	F1	0
0117		CB open Monitoring	0 to 65535	1	-	F1	0
0118-011F		Reserved					
0120	VT Ratio	Line VT primary	5 to 6500	1	[kV]/100	F1	
0121		Line VT Sec.	570 to 1300 2200 to 4800	1	[V]/10	F1	
0122		E/Gnd VT Primary	5 to 6500	1	[kV]/100	F1	
0123		E/GND VT Sec.	570 to 1300	1	[V]/10	F1	
0124		VT connection	0 to 3	1	-	F90	0
0125		Protection configuration V>	0 to 1	1	-	F91	0
0126		Protection configuration V<	0 to 1	1	-	F91	0
0127 - 0136		Reserved					
0137	Voltage Advanced Settings	Reserved					
0138		IDMT interlock by DMT stage	0 to 1	1	-	F88	0
0139		[27] Hysteresis	100 to 120	1	[1]/100	F1	
013A		[59] Hysteresis	80 to 100	1	[1]/100	F1	
013B – 013F		Reserved					
GLOBAL SETTINGS							
0140	LOC	Language	0 to 6	1	-	F52	0
0141		Default display	0 to 5	1	-	F53	0
0142		LEDs Reset by	0 to 2	1	-	F54	0
0143		Ltchd Outp Reset	0 to 2	1	-	F54	0
0144		Trip Info Reset	0 to 2	1	-	F54	0
0145		Alarm Display Reset	0 to 1	1	-	F55	0

Address	Group	Description	Values range	Step	Unit	Format	Default Value
0146		Nominal frequency	0 to 1	1	-	F57	0
0147		Control Keys Confirmation	0 to 1	1	-	F82	0
0148-014F		Reserved					
0150	SETTING GROUP SELECT	Number of Setting Groups	0 to 1	1	-	F71	0
0151		Setting group change	0 to 1	1	-	F32	0
0152		t Change Setting G1->G2	0 to 20000	1	[s]/100	F1	0
0153-015F		Reserved					
0160	VT Supervision	VTS Supervision	0 to 1	1	-	F66	
0161		Detection Mode	0 to 2	1	-	F92	
0162		Delta Vr	20 to 1300	1	[V]/10	F1	
0163		tVTS	0 to 10000	1	[s]/100	F1	
0164		Inhibit VTS/52a	0 to 1		-	F63	
0165		Block function V<	0 to 1		-	F63	
0166		Block function V>	0 to 1		-	F63	
0167		Block function VN>	0 to 1		-	F63	
0168		Block function V1<	0 to 1		-	F63	
0169		Block function V2<	0 to 1		-	F63	
016A		Block function frequency	0 to 1		-	F63	
016A - 0173		Reserved					
0174	[81] Advanced settings	Protect. Frequency block	5 to 100	1	[V]	F1	
0175		Reserved					
0176		Meas. Validation NB (halfcycles)	1 to 10	1	-	F1	4
0176 – 017F		Reserved					
0180	CIRCUIT BREAKER	tOpen pulse min	10 to 1000	1	[s]/100	F1	50
0181		tClose Pulse	10 to 1000	1	[s]/100	F1	50
0182		Time Delay for close Command	0 to 20000	1	[s]/100	F1	0
0183		Reserved					
0184		tCB FLT ext.sign.	1 to 200	1	[s]	F1	16
0185		Remote Mode	0 to 1	1	-	F73	
0186 - 0188		Reserved					
0189		CB Supervision?	0 to 1	1	-	F63	0
018A		Max CB Open Time	10 to 1000	1	[s]/100	F1	10
018B		Max CB Close Time	10 to 1000	1	[s]/100	F1	10
018C - 0199		Reserved					
019A	DISTURBANCE RECORDER	Pre-Time	10 to 200	1	[s]/100	F1	10

Address	Group	Description	Values range	Step	Unit	Format	Default Value
019B		Post TripTime	10 to 100	1	[s]/100	F1	10
019C		Distrurb Rec Trig	0 to 1	1	-	F65	0
019D		Max record Time	10 to 400	1	[s]/100	F1	10
019E-01A4		Reserved					
01A5	COMMISIONING	Maintenace Mode	0 to 2	1	-	F62	0
01A6		Test Pattern			bits	F36	00000000
01A7		Contact Test Time	0 to 20000	1	[s]/100	F1	10
01A8		Reserved					
01A9		Functional Test Pattern	0 to 18	1	-	F76	0
01AA		Functional Test End	0 to 1	1	-	F77	0
01AB		Functional Test Time	10 to 20000	1	[s]/100	F1	10
01AC-01FF		Reserved					

Page 2h : setting Group 1

Access in reading and in writing

Address	Group	Description	Values range	Step	Unit	Format	Default Value
0200	Setting Group 1 / Protection G1/Overvoltage	V> ?	0 - 8	1	-	F16	0
0201		V> Threshold	1 to 65535	1	[V]/10	F1	
0202		V> Delay Type	1 to 15	1	-	F18	
0203		tV>/TMS/TD	1 to 65535	1	[s]/100	F1	
0204		V> Reset Delay Type	0 - 1	1	-	F41	
0205		V> DMT tReset	1 to 65535	1	[s]/100	F1	
0206		V>>?	0 - 8	1	-	F16	
0207		V>> Threshold	1 to 65535	1	[V]/10	F1	
0208		tV>>	1 to 65535	1	[s]/100	F1	
0209		V>>>?	0 to 15	1	-	F16	
020A		V>>> Threshold	1 to 65535	1	[V]/10	F1	
020B		tV>>>	1 to 65535	1	[s]/100	F1	
020C	Setting Group 1 / Protection G1 /Undervoltage	V<?	0 - 8	1	-	F16	
020D		V< Threshold	1 to 65535	1	[V]/10	F1	
020E		V< Delay Type	0 to 15	1	[-]	F18	
020F		tV</TMS/TD	1 to 65535	1	[s] /100	F1	
0210		V< Reset Delay Type	0 - 1	1	[-]	F41	
0211		V< DMT tReset	1 to 65535	1	[s] /100	F1	
0212		V<<?	0 - 8	1	[-]	F16	
0213		V<< Threshold	1 to 65535	1	[V]/10	F1	
0214		tV<<	1 to 65535	1	[s] /100	F1	
0215		V<<<?	0 - 8	1	[-]	F16	
0216		V<<< Threshold	1 to 65535	1	[V]/10	F1	
0217		tV<<<	1 to 65535	1	[s] /100	F1	
0218	Setting Group 1 / Protection G1 /Positive sequence undervoltage	V1<?	0 - 8	1	[-]	F16	
0219		V1< Threshold	1 to 65535	1	[V]/10	F1	
021A		V1< Delay Type	0 to 15	1	[-]	F18	
021B		tV1< TMS/TD	1 to 65535	1	[s] /100	F1	
021C		V1< Reset Delay Type	0 - 1	1	[-]	F41	
021D		V1< DMT tReset	1 to 65535	1	[s] /100	F1	
021E		V1<<?	0 - 8	1	[-]	F16	
021F		V1<< Threshold	1 to 65535	1	[V]/10	F1	
0220		tV1<<	1 to 65535	1	[s] /100	F1	

Address	Group	Description	Values range	Step	Unit	Format	Default Value
0221	Setting Group 1 / Protection G1 /Negative sequence undervoltage	V2>?	0 - 8	1	[-]	F16	
0222		V2> Threshold	1 to 65535	1	[V]/10	F1	
0223		V2> Delay Type	0 to 15	1	[-]	F18	
0224		tV2> TMS/TD	1 to 65535	1	[s] /100	F1	
0225		V2> Reset Delay Type	0 - 1	1	[-]	F41	
0226		V2> DMT tReset	1 to 65535	1	[s] /100	F1	
0227		V2>>?	0 - 8	1	[-]	F16	
0228		V2>> Threshold	1 to 65535	1	[V]/10	F1	
0229		tV2>>	1 to 65535	1	[s] /100	F1	
022A	Setting Group 1 / Protection G1 /Earth fault overvoltage	VN>?	0 to 4	1	[-]	F95	
022B		VN> Threshold	1 to 65535	1	[V]/10	F1	
022C		VN> Delay Type	0 to 15	1	[-]	F18	
022D		tVN>/TMS/TD	1 to 65535	1	[s] /100	F1	
022E		VN> Reset Delay Type	0 - 1	1	[-]	F41	
022F		VN> DMT tReset	1 to 65535	1	[s] /100	F1	
0230		VN>>?	0 to 4	1	[-]	F95	
0231		VN>> Threshold	1 to 65535	1	[V]/10	F1	
0232		tVN>>	1 to 65535	1	[s] /100	F1	
0233		VN>>>?	0 to 4	1	[-]	F95	
0234		VN>>> Threshold	1 to 65535	1	[V]/10	F1	
0235		tVN>>>	1 to 65535	1	[s] /100	F1	
0236	Setting Group 1 / Protection G1 /Frequency	f1?	0 to 4	1	[-]	F84	
0237		f1 Threshold	1 to 65535	1	[Hz]/100	F1	
0238		tf1	1 to 65535	1	[s] /100	F1	
0239		f2?	0 to 4	1	[-]	F84	
023A		f2 Threshold	1 to 65535	1	[Hz]/100	F1	
023B		tf2	1 to 65535	1	[s] /100	F1	
023C		f3?	0 to 4	1	[-]	F84	
023D		f3 Threshold	1 to 65535	1	[Hz]/100	F1	
023E		tf3	1 to 65535	1	[s] /100	F1	
023F		f4?	0 to 4	1	[-]	F84	
0240		f4 Threshold	1 to 65535	1	[Hz]/100	F1	
0241		tf4	1 to 65535	1	[s] /100	F1	
0242		f5?	0 to 4	1	[-]	F84	
0243		f5 Threshold	1 to 65535	1	[Hz]/100	F1	
0244		tf5	1 to 65535	1	[s] /100	F1	

Address	Group	Description	Values range	Step	Unit	Format	Default Value
0245		f6?	0 to 4	1	[-]	F84	
0246		f6 Threshold	1 to 65535	1	[Hz]/100	F1	
0247		tf6	1 to 65535	1	[s] /100	F1	
0252	Setting Group 1 / Protection G1 /Auxiliary timers	AUX1?	0 to 3	1	[-]	F94	
0253		tAUX1	0 to 60000	1	[s] /100	F1	
0254		AUX2?	0 to 3	1	[-]	F94	
0255		tAUX2	0 to 60000	1	[s] /100	F1	
0256		AUX3?	0 to 3	1	[-]	F94	
0257		tAUX3	0 to 60000	1	[s] /100	F1	
0258	Setting group 1 /Inputs configuration G1	Reverse Input Logic	0 to 5	1	[-]	F35	
0259		Maintenance Mode	0 to 5	1	[-]	F35	
025A		Reset Latched Signaling	0 to 5	1	[-]	F35	
025B		Reset Latched Outputs	0 to 5	1	[-]	F35	
025C		Blocking tV>	0 to 5	1	[-]	F35	
025D		Blocking tV>>	0 to 5	1	[-]	F35	
025E		Blocking tV>>>	0 to 5	1	[-]	F35	
025F		Blocking tV<	0 to 5	1	[-]	F35	
0260		Blocking tV<<	0 to 5	1	[-]	F35	
0261		Blocking tV<<<	0 to 5	1	[-]	F35	
0262		Blocking tV1<	0 to 5	1	[-]	F35	
0263		Blocking tV1<<	0 to 5	1	[-]	F35	
0264		Blocking tV2>	0 to 5	1	[-]	F35	
0265		Blocking tV2>>	0 to 5	1	[-]	F35	
0266		Blocking tVN>	0 to 5	1	[-]	F35	
0267		Blocking tVN>>	0 to 5	1	[-]	F35	
0268		Blocking tVN>>>	0 to 5	1	[-]	F35	
0269		Blocking tf1	0 to 5	1	[-]	F35	
026A		Blocking tf2	0 to 5	1	[-]	F35	
026B		Blocking tf3	0 to 5	1	[-]	F35	
026C		Blocking tf4	0 to 5	1	[-]	F35	
026D		Blocking tf5	0 to 5	1	[-]	F35	
026E		Blocking tf6	0 to 5	1	[-]	F35	
0272		AUX1	0 to 5	1	[-]	F35	
0273		AUX2	0 to 5	1	[-]	F35	
0274		AUX3	0 to 5	1	[-]	F35	
0275		AUX4	0 to 5	1	[-]	F35	
0276		AUX5	0 to 5	1	[-]	F35	
0277		CB status 52A	0 to 5	1	[-]	F35	
0278		CB status 52B	0 to 5	1	[-]	F35	

Address	Group	Description	Values range	Step	Unit	Format	Default Value
0279		CB FLT ext.	0 to 5	1	[-]	F35	
027A		Setting Group 2	0 to 5	1	[-]	F35	
027B		Manual Close	0 to 5	1	[-]	F35	
027C		Manual Trip	0 to 5	1	[-]	F35	
027D		VTS	0 to 5	1	[-]	F35	
027E		Strt Disturb	0 to 5	1	[-]	F35	
027F		Local Mode	0 to 5	1	[-]	F35	
0280		Time synchr	0 to 5	1	[-]	F35	
0281	Setting group 1 /Outputs configuration G1	Latched outputs	0 to 6	1	[-]	F36	
0282		Reverse outp. Logic	0 to 6	1	[-]	F36	
0283		Protect. Trip	0 to 6	1	[-]	F36	
0284		Protection Trip (pulse)	0 to 6	1	[-]	F36	
0285		Trip CB	0 to 6	1	[-]	F36	
0286		Close CB	0 to 6	1	[-]	F36	
0287		Alarm	0 to 6	1	[-]	F36	
0288		Start V>	0 to 6	1	[-]	F36	
0289		Start V>>	0 to 6	1	[-]	F36	
028A		Start V>>>	0 to 6	1	[-]	F36	
028B		Start V<	0 to 6	1	[-]	F36	
028C		start V<<	0 to 6	1	[-]	F36	
028D		start V<<<	0 to 6	1	[-]	F36	
028E		start V1<	0 to 6	1	[-]	F36	
028F		start V1<<	0 to 6	1	[-]	F36	
0290		start V2>	0 to 6	1	[-]	F36	
0291		Start V2>>	0 to 6	1	[-]	F36	
0292		Start VN>	0 to 6	1	[-]	F36	
0293		start VN>>	0 to 6	1	[-]	F36	
0294		Start VN>>>	0 to 6	1	[-]	F36	
0295		Start f1	0 to 6	1	[-]	F36	
0296		Start f2	0 to 6	1	[-]	F36	
0297		Start f3	0 to 6	1	[-]	F36	
0298		Start f4	0 to 6	1	[-]	F36	
0299		Start f5	0 to 6	1	[-]	F36	
029A		Start f6	0 to 6	1	[-]	F36	
029E		AUX1	0 to 6	1	[-]	F36	
029F		AUX2	0 to 6	1	[-]	F36	
02A0		AUX3	0 to 6	1	[-]	F36	
02A1		AUX4	0 to 6	1	[-]	F36	
02A2		AUX5	0 to 6	1	[-]	F36	
02A3		tV>	0 to 6	1	[-]	F36	

Address	Group	Description	Values range	Step	Unit	Format	Default Value
02A4		tV>>	0 to 6	1	[-]	F36	
02A5		tV>>>	0 to 6	1	[-]	F36	
02A6		tV<	0 to 6	1	[-]	F36	
02A7		tV<<	0 to 6	1	[-]	F36	
02A8		tV<<<	0 to 6	1	[-]	F36	
02A9		tV1<	0 to 6	1	[-]	F36	
02AA		tV1<<	0 to 6	1	[-]	F36	
02AB		tV2>	0 to 6	1	[-]	F36	
02AC		tV2>>	0 to 6	1	[-]	F36	
02AD		tVN>	0 to 6	1	[-]	F36	
02AE		tVN>>	0 to 6	1	[-]	F36	
02AF		tVN>>>	0 to 6	1	[-]	F36	
02B0		tf1	0 to 6	1	[-]	F36	
02B1		tf2	0 to 6	1	[-]	F36	
02B2		tf3	0 to 6	1	[-]	F36	
02B3		tf4	0 to 6	1	[-]	F36	
02B4		tf5	0 to 6	1	[-]	F36	
02B5		tf6	0 to 6	1	[-]	F36	
02B9		tAUX1	0 to 6	1	[-]	F36	
02BA		tAUX2	0 to 6	1	[-]	F36	
02BB		tAUX3	0 to 6	1	[-]	F36	
02BC		CB Alarm	0 to 6	1	[-]	F36	
02BD		tCB Faulty ext.	0 to 6	1	[-]	F36	
02BE		Setting Group 1	0 to 6	1	[-]	F36	
02BF		tVTS	0 to 6	1	[-]	F36	
02C0		fout	0 to 6	1	[-]	F36	
02C1	Setting group 1 /LED's configuration G1	Latched LEDs	0 to 5	1	[-]	F39	
02C2		Alarm	0 to 5	1	[-]	F39	
02C3		Start V>	0 to 5	1	[-]	F39	
02C4		Start V>>	0 to 5	1	[-]	F39	
02C5		Start V>>>	0 to 5	1	[-]	F39	
02C6		Start V<	0 to 5	1	[-]	F39	
02C7		start V<<	0 to 5	1	[-]	F39	
02C8		start V<<<	0 to 5	1	[-]	F39	
02C9		start V1<	0 to 5	1	[-]	F39	
02CA		start V1<<	0 to 5	1	[-]	F39	
02CB		start V2>	0 to 5	1	[-]	F39	
02CC		Start V2>>	0 to 5	1	[-]	F39	
02CD		Start VN>	0 to 5	1	[-]	F39	
02CE		start VN>>	0 to 5	1	[-]	F39	

Address	Group	Description	Values range	Step	Unit	Format	Default Value
02CF		Start VN>>>	0 to 5	1	[-]	F39	
02D0		Start f1	0 to 5	1	[-]	F39	
02D1		Start f2	0 to 5	1	[-]	F39	
02D2		Start f3	0 to 5	1	[-]	F39	
02D3		Start f4	0 to 5	1	[-]	F39	
02D4		Start f5	0 to 5	1	[-]	F39	
02D5		Start f6	0 to 5	1	[-]	F39	
02D9		AUX1	0 to 5	1	[-]	F39	
02DA		AUX2	0 to 5	1	[-]	F39	
02DB		AUX3	0 to 5	1	[-]	F39	
02DC		AUX4	0 to 5	1	[-]	F39	
02DD		AUX5	0 to 5	1	[-]	F39	
02DE		tV>	0 to 5	1	[-]	F39	
02DF		tV>>	0 to 5	1	[-]	F39	
02E0		tV>>>	0 to 5	1	[-]	F39	
02E1		tV<	0 to 5	1	[-]	F39	
02E2		tV<<	0 to 5	1	[-]	F39	
02E3		tV<<<	0 to 5	1	[-]	F39	
02E4		tV1<	0 to 5	1	[-]	F39	
02E5		tV1<<	0 to 5	1	[-]	F39	
02E6		tV2>	0 to 5	1	[-]	F39	
02E7		tV2>>	0 to 5	1	[-]	F39	
02E8		tVN>	0 to 5	1	[-]	F39	
02E9		tVN>>	0 to 5	1	[-]	F39	
02EA		tVN>>>	0 to 5	1	[-]	F39	
02EB		tf1	0 to 5	1	[-]	F39	
02EC		tf2	0 to 5	1	[-]	F39	
02ED		tf3	0 to 5	1	[-]	F39	
02EE		tf4	0 to 5	1	[-]	F39	
02EF		tf5	0 to 5	1	[-]	F39	
02F0		tf6	0 to 5	1	[-]	F39	
02F4		tAUX1	0 to 5	1	[-]	F39	
02F5		tAUX2	0 to 5	1	[-]	F39	
02F6		tAUX3	0 to 5	1	[-]	F39	
02F7		Local Mode	0 to 5	1	[-]	F39	
02F8		CB Alarm	0 to 5	1	[-]	F39	
02F9		Maintenance Mode	0 to 5	1	[-]	F39	
02FA		tCB FLT ext.	0 to 5	1	[-]	F39	
02FB		Setting Group	0 to 5	1	[-]	F39	
02FC		tVTS	0 to 5	1	[-]	F39	
02FD		fout	0 to 5	1	[-]	F39	

Page 3h: Setting Group 2

Access in reading and in writing

Address	Group	Description	Values range	Step	Unit	Format	Default Value
0300	Setting Group 2 / Protection G2/Overvoltage	V> ?	0 - 8	1	-	F16	0
0301		V> Threshold	1 to 65535	1	[V]/10	F1	
0302		V> Delay Type	0 to 15	1	-	F18	
0303		tV>/TMS/TD	1 to 65535	1	[s]/100	F1	
0304		V> Reset Delay Type	0 - 1	1	-	F41	
0305		V> DMT tReset	1 to 65535	1	[s]/100	F1	
0306		V>>?	0 - 8	1	-	F16	
0307		V>> Threshold	1 to 65535	1	[V]/10	F1	
0308		tV>>	1 to 65535	1	[s]/100	F1	
0309		V>>>?	0 to 8	1	-	F16	
030A		V>>> Threshold	1 to 65535	1	[V]/10	F1	
030B		tV>>>	1 to 65535	1	[s]/100	F1	
030C	Setting Group 2 / Protection G2 /Undervoltage	V<?	0 to 8	1	[-]	F16	
030D		V< Threshold	1 to 65535	1	[V]/10	F1	
030E		V< Delay Type	0 to 15	1	[-]	F18	
030F		tV</TMS/TD	1 to 65535	1	[s] /100	F1	
0310		V< Reset Delay Type	0 - 1	1	[-]	F41	
0311		V< DMT tReset	1 to 65535	1	[s] /100	F1	
0312		V<<?	0 - 8	1	[-]	F16	
0313		V<< Threshold	1 to 65535	1	[V]/10	F1	
0314		tV<<	1 to 65535	1	[s] /100	F1	
0315		V<<<?	0 - 8	1	[-]	F16	
0316		V<<< Threshold	1 to 65535	1	[V]/10	F1	
0317		tV<<<	1 to 65535	1	[s] /100	F1	
0318	Setting Group 2 / Protection G2 /Positive sequence undervoltage	V1<?	0 - 8	1	[-]	F16	
0319		V1< Threshold	1 to 65535	1	[V]/10	F1	
031A		V1< Delay Type	0 to 15	1	[-]	F18	
031B		tV1< TMS/TD	1 to 65535	1	[s] /100	F1	
031C		V1< Reset Delay Type	0 - 1	1	[-]	F41	
031D		V1< DMT tReset	1 to 65535	1	[s] /100	F1	
031E		V1<<?	0 - 8	1	[-]	F16	
031F		V1<< Threshold	1 to 65535	1	[V]/10	F1	
0320		tV1<<	1 to 65535	1	[s] /100	F1	

Address	Group	Description	Values range	Step	Unit	Format	Default Value
0321	Setting Group 2 / Protection G2 /Negative sequence undervoltage	V2>?	0 - 8	1	[-]	F16	
0322		V2> Threshold	1 to 65535	1	[V]/10	F1	
0323		V2> Delay Type	0 to 15	1	[-]	F18	
0324		tV2> TMS/TD	1 to 65535	1	[s] /100	F1	
0325		V2> Reset Delay Type	0 - 1	1	[-]	F41	
0326		V2> DMT tReset	1 to 65535	1	[s] /100	F1	
0327		V2>>?	0 - 8	1	[-]	F16	
0328		V2>> Threshold	1 to 65535	1	[V]/10	F1	
0329		tV2>>	1 to 65535	1	[s] /100	F1	
032A	Setting Group 2 / Protection G2 /Earth fault overvoltage	UN>?	0 to 4	1	[-]	F95	
032B		VN> Threshold	1 to 65535	1	[V]/10	F1	
032C		VN> Delay Type	0 to 15	1	[-]	F18	
032D		tVN>/TMS/TD	1 to 65535	1	[s] /100	F1	
032E		VN> Reset Delay Type	0 - 1	1	[-]	F41	
032F		VN> DMT tReset	1 to 65535	1	[s] /100	F1	
0330		VN>>?	0 to 4	1	[-]	F95	
0331		VN>> Threshold	1 to 65535	1	[V]/10	F1	
0332		tVN>>	1 to 65535	1	[s] /100	F1	
0333		VN>>>?	0 to 4	1	[-]	F95	
0334		VN>>> Threshold	1 to 65535	1	[V]/10	F1	
0335		tVN>>>	1 to 65535	1	[s] /100	F1	
0336	Setting Group 2 / Protection G2 /Frequency	f1?	0 to 4	1	[-]	F84	
0337		f1 Threshold	1 to 65535	1	[Hz]/100	F1	
0338		tf1	1 to 65535	1	[s] /100	F1	
0339		f2?	0 to 4	1	[-]	F84	
033A		f2 Threshold	1 to 65535	1	[Hz]/100	F1	
033B		tf2	1 to 65535	1	[s] /100	F1	
033C		f3?	0 to 4	1	[-]	F84	
033D		f3 Threshold	1 to 65535	1	[Hz]/100	F1	
033E		tf3	1 to 65535	1	[s] /100	F1	
033F		f4?	0 to 4	1	[-]	F84	
0340		f4 Threshold	1 to 65535	1	[Hz]/100	F1	
0341		tf4	1 to 65535	1	[s] /100	F1	
0342		f5?	0 to 4	1	[-]	F84	
0343		f5 Threshold	1 to 65535	1	[Hz]/100	F1	
0344		tf5	1 to 65535	1	[s] /100	F1	

Address	Group	Description	Values range	Step	Unit	Format	Default Value
0345		f6?	0 to 4	1	[-]	F84	
0346		f6 Threshold	1 to 65535	1	[Hz]/100	F1	
0347		tf6	1 to 65535	1	[s] /100	F1	
0352	Setting Group 2 / Protection G2 /Auxiliary timers	AUX1?	0 to 3	1	[-]	F94	
0353		tAUX1	1 to 60000	1	[s] /100	F1	
0354		AUX2?	0 to 3	1	[-]	F94	
0355		tAUX2	1 to 60000	1	[s] /100	F1	
0356		AUX3?	0 to 3	1	[-]	F94	
0257		tAUX3	1 to 60000	1	[s] /100	F1	
0358	Setting group 2 /Inputs configuration G2	Reverse Input Logic	0 to 5	1	[-]	F35	
0359		Maintenance Mode	0 to 5	1	[-]	F35	
035A		Reset Latched Signaling	0 to 5	1	[-]	F35	
035B		Reset Latched Outputs	0 to 5	1	[-]	F35	
035C		Blocking tV>	0 to 5	1	[-]	F35	
035D		Blocking tV>>	0 to 5	1	[-]	F35	
035E		Blocking tV>>>	0 to 5	1	[-]	F35	
035F		Blocking tV<	0 to 5	1	[-]	F35	
0360		Blocking tV<<	0 to 5	1	[-]	F35	
0361		Blocking tV<<<	0 to 5	1	[-]	F35	
0362		Blocking tV1<	0 to 5	1	[-]	F35	
0363		Blocking tV1<<	0 to 5	1	[-]	F35	
0364		Blocking tV2>	0 to 5	1	[-]	F35	
0365		Blocking tV2>>	0 to 5	1	[-]	F35	
0366		Blocking tVN>	0 to 5	1	[-]	F35	
0367		Blocking tVN>>	0 to 5	1	[-]	F35	
0368		Blocking tVN>>>	0 to 5	1	[-]	F35	
0369		Blocking tf1	0 to 5	1	[-]	F35	
036A		Blocking tf2	0 to 5	1	[-]	F35	
036B		Blocking tf3	0 to 5	1	[-]	F35	
036C		Blocking tf4	0 to 5	1	[-]	F35	
036D		Blocking tf5	0 to 5	1	[-]	F35	
036E		Blocking tf6	0 to 5	1	[-]	F35	
0372		AUX1	0 to 5	1	[-]	F35	
0373		AUX2	0 to 5	1	[-]	F35	
0374		AUX3	0 to 5	1	[-]	F35	
0375		AUX4	0 to 5	1	[-]	F35	
0376		AUX5	0 to 5	1	[-]	F35	
0377		CB status 52A	0 to 5	1	[-]	F35	
0378		CB status 52B	0 to 5	1	[-]	F35	

Address	Group	Description	Values range	Step	Unit	Format	Default Value
0379		CB FLT ext.	0 to 5	1	[-]	F35	
037A		Setting Group 2	0 to 5	1	[-]	F35	
0327B		Manual Close	0 to 5	1	[-]	F35	
037C		Manual Trip	0 to 5	1	[-]	F35	
037D		VTS	0 to 5	1	[-]	F35	
037E		Strt Disturb	0 to 5	1	[-]	F35	
037F		Local Mode	0 to 5	1	[-]	F35	
0380		Time synchr	0 to 5	1	[-]	F35	
0381	Setting group 2 /Outputs configuration G2	Latched outputs	0 to 6	1	[-]	F36	
0382		Reverse outp. Logic	0 to 6	1	[-]	F36	
0383		Protect. Trip	0 to 6	1	[-]	F36	
0384		Protection Trip (pulse)	0 to 6	1	[-]	F36	
0385		Trip CB	0 to 6	1	[-]	F36	
0386		Close CB	0 to 6	1	[-]	F36	
0387		Alarm	0 to 6	1	[-]	F36	
0388		Start V>	0 to 6	1	[-]	F36	
0389		Start V>>	0 to 6	1	[-]	F36	
038A		Start V>>>	0 to 6	1	[-]	F36	
038B		Start V<	0 to 6	1	[-]	F36	
038C		start V<<	0 to 6	1	[-]	F36	
038D		start V<<<	0 to 6	1	[-]	F36	
038E		start V1<	0 to 6	1	[-]	F36	
038F		start V1<<	0 to 6	1	[-]	F36	
0390		start V2>	0 to 6	1	[-]	F36	
0391		Start V2>>	0 to 6	1	[-]	F36	
0392		Start VN>	0 to 6	1	[-]	F36	
0393		start VN>>	0 to 6	1	[-]	F36	
0394		Start VN>>>	0 to 6	1	[-]	F36	
0395		Start f1	0 to 6	1	[-]	F36	
0396		Start f2	0 to 6	1	[-]	F36	
0397		Start f3	0 to 6	1	[-]	F36	
0398		Start f4	0 to 6	1	[-]	F36	
0399		Start f5	0 to 6	1	[-]	F36	
039A		Start f6	0 to 6	1	[-]	F36	
039E		AUX1	0 to 6	1	[-]	F36	
039F		AUX2	0 to 6	1	[-]	F36	
03A0		AUX3	0 to 6	1	[-]	F36	
03A1		AUX4	0 to 6	1	[-]	F36	
03A2		AUX5	0 to 6	1	[-]	F36	
03A3		tV>	0 to 6	1	[-]	F36	

Address	Group	Description	Values range	Step	Unit	Format	Default Value
03A4		tV>>	0 to 6	1	[-]	F36	
03A5		tV>>>	0 to 6	1	[-]	F36	
03A6		tV<	0 to 6	1	[-]	F36	
03A7		tV<<	0 to 6	1	[-]	F36	
03A8		tV<<<	0 to 6	1	[-]	F36	
03A9		tV1<	0 to 6	1	[-]	F36	
03AA		tV1<<	0 to 6	1	[-]	F36	
03AB		tV2>	0 to 6	1	[-]	F36	
03AC		tV2>>	0 to 6	1	[-]	F36	
03AD		tVN>	0 to 6	1	[-]	F36	
03AE		tVN>>	0 to 6	1	[-]	F36	
03AF		tVN>>>	0 to 6	1	[-]	F36	
03B0		tf1	0 to 6	1	[-]	F36	
03B1		tf2	0 to 6	1	[-]	F36	
03B2		tf3	0 to 6	1	[-]	F36	
03B3		tf4	0 to 6	1	[-]	F36	
03B4		tf5	0 to 6	1	[-]	F36	
03B5		tf6	0 to 6	1	[-]	F36	
03B9		tAUX1	0 to 6	1	[-]	F36	
03BA		tAUX2	0 to 6	1	[-]	F36	
03BB		tAUX3	0 to 6	1	[-]	F36	
03BC		CB Alarm	0 to 6	1	[-]	F36	
03BD		tCB Faulty ext.	0 to 6	1	[-]	F36	
03BE		Setting Group 1	0 to 6	1	[-]	F36	
03BF		tVTS	0 to 6	1	[-]	F36	
03C0		fout	0 to 6	1	[-]	F36	
03C1	Setting group 2 /LED's configuration G2	Latched LEDs	0 to 5	1	[-]	F39	
03C2		Alarm	0 to 5	1	[-]	F39	
03C3		Start V>	0 to 5	1	[-]	F39	
03C4		Start V>>	0 to 5	1	[-]	F39	
03C5		Start V>>>	0 to 5	1	[-]	F39	
03C6		Start V<	0 to 5	1	[-]	F39	
03C7		start V<<	0 to 5	1	[-]	F39	
03C8		start V<<<	0 to 5	1	[-]	F39	
03C9		start V1<	0 to 5	1	[-]	F39	
03CA		start V1<<	0 to 5	1	[-]	F39	
03CB		start V2>	0 to 5	1	[-]	F39	
03CC		Start V2>>	0 to 5	1	[-]	F39	
03CD		Start VN>	0 to 5	1	[-]	F39	
03CE		start VN>>	0 to 5	1	[-]	F39	

Address	Group	Description	Values range	Step	Unit	Format	Default Value
03CF		Start VN>>>	0 to 5	1	[-]	F39	
03D0		Start f1	0 to 5	1	[-]	F39	
03D1		Start f2	0 to 5	1	[-]	F39	
03D2		Start f3	0 to 5	1	[-]	F39	
03D3		Start f4	0 to 5	1	[-]	F39	
03D4		Start f5	0 to 5	1	[-]	F39	
03D5		Start f6	0 to 5	1	[-]	F39	
03D9		AUX1	0 to 5	1	[-]	F39	
03DA		AUX2	0 to 5	1	[-]	F39	
03DB		AUX3	0 to 5	1	[-]	F39	
03DC		AUX4	0 to 5	1	[-]	F39	
03DD		AUX5	0 to 5	1	[-]	F39	
03DE		tV>	0 to 5	1	[-]	F39	
03DF		tV>>	0 to 5	1	[-]	F39	
03E0		tV>>>	0 to 5	1	[-]	F39	
03E1		tV<	0 to 5	1	[-]	F39	
03E2		tV<<	0 to 5	1	[-]	F39	
03E3		tV<<<	0 to 5	1	[-]	F39	
03E4		tV1<	0 to 5	1	[-]	F39	
03E5		tV1<<	0 to 5	1	[-]	F39	
03E6		tV2>	0 to 5	1	[-]	F39	
03E7		tV2>>	0 to 5	1	[-]	F39	
03E8		tVN>	0 to 5	1	[-]	F39	
03E9		tVN>>	0 to 5	1	[-]	F39	
03EA		tVN>>>	0 to 5	1	[-]	F39	
03EB		tf1	0 to 5	1	[-]	F39	
03EC		tf2	0 to 5	1	[-]	F39	
03ED		tf3	0 to 5	1	[-]	F39	
03EE		tf4	0 to 5	1	[-]	F39	
03EF		tf5	0 to 5	1	[-]	F39	
03F0		tf6	0 to 5	1	[-]	F39	
03F4		tAUX1	0 to 5	1	[-]	F39	
03F5		tAUX2	0 to 5	1	[-]	F39	
03F6		tAUX3	0 to 5	1	[-]	F39	
03F7		Local Mode	0 to 5	1	[-]	F39	
03F8		CB Alarm	0 to 5	1	[-]	F39	
03F9		Maintenance Mode	0 to 5	1	[-]	F39	
03FA		tCB FLT ext.	0 to 5	1	[-]	F39	
03FB		Setting Group	0 to 5	1	[-]	F39	
03FC		tVTS	0 to 5	1	[-]	F39	
03FD		fout	0 to 5	1	[-]	F39	

Page 4h : Remote Controls

In P1V it is possible to use both functions Function 5 or Function 6

Access in writing.

MODBUS Function 6

Note: A one control can be executed in a one message only. Two control commands in a one message will be rejected by P1V

Address	Group	Description	Values range	Step	Unit	Format	Default Value
0400	Remote control	Remote control word 1	0 to 15	bits	-	F38	0
0401		Remote control word 2	0 to 15	bits	-	F38A	0
0402		Remote control word 3	0 to 15	bits	-	F38B	0

Pages 5h/6h

These pages are reserved.

Page 7h

Access in quick reading only (MODBUS 07 function)

Address	Group	Description	Values range	Step	Unit	Format	Default Value
0700	Quick reading byte	Relay status description		1	-	F49	0

Page 8h: Time Synchronization

Access in writing for n words (function 16). The time synchronization format is based on 8 bits (4 words) (Inverted IEC 60870-5-4 CP56Time2a):

Timer	Address (hex)	Nb bytes	Mask (hex)	Values range	Unit
	0800	1 (Hi)			
Year		1 (Lo)	7F	0 – 99 (2000-2099)	Year
Month	0801	1 (Hi)	0F	1 - 12	month
Day of week		1 (Lo)	E0	0 – 6 (Sun, Mon, Tue, Wed, Thu, Fri, Sat)	-
day of month		1 (Lo)	1F	1 – 31	Day
Season	0802	1 (Hi)	80	0 – 1 (summer-winter)	
Hour		1 (Hi)	1F	0-23	Hour
Invalidity		1 (Lo)	80	0 -1 (valid – invalid)	
Minute		1 (Lo)	3F	0-59	Minute
Millisecond pF+pf	0803	2	FFFF	0 – 59999	ms

Mapping access characteristics

- Description of accessible addresses in reading of words (**function 03** and **04**).

PAGE 00h 0000h to 0085h	PAGE 01h 0100h to 01ABh	PAGE 02h 0200h to 02FDh
PAGE 03h 0300h to 03FDh		

- Definition of accessible addresses in writing of 1 word (**function 06**).

PAGE 01h 0100h to 01ABh	PAGE 02h 0200h to 02FDh	PAGE 03h 0300h to 03FDh
----------------------------	----------------------------	----------------------------

- Definition of accessible addresses in writing of n words (**function 16**).

PAGE 01h 0100h to 01ABh	PAGE 02h 0200h to 02FDh	PAGE 03h 0300h to 03FDh
PAGE 08h 0800h to 0803h		

- Definition of accessible addresses in reading of bits (**function 01** and **02**).

Not available

- Definition of accessible addresses in writing of 1 bit (**function 05**).

PAGE 04h
0400h to 0402h

Note: The bits number must not be higher than 16.

Page 9h to 21h: Disturbance Record Data (25 pages)

Access in words writing (**function 03**)
Each disturbance mapping page contain 250 words.

Address	Contents
0900h to 09FAh	250 disturbance data words
0A00h to 0AFAh	250 disturbance data words
0B00h to 0BFAh	250 disturbance data words
0C00h to 0CFAh	250 disturbance data words
0D00h to 0DFAh	250 disturbance data words
0E00h to 0EFAh	250 disturbance data words
0F00h to 0FFAh	250 disturbance data words
1000h to 10FAh	250 disturbance data words
1100h to 11FAh	250 disturbance data words
1200h to 12FAh	250 disturbance data words
1300h to 13FAh	250 disturbance data words
1400h to 14FAh	250 disturbance data words
1500h to 15FAh	250 disturbance data words
1600h to 16FAh	250 disturbance data words
1700h to 17FAh	250 disturbance data words

1800h to 18FAh	250 disturbance data words
1900h to 19FAh	250 disturbance data words
1A00h to 1AFAh	250 disturbance data words
1B00h to 1BFAh	250 disturbance data words
1C00h to 1CFAh	250 disturbance data words
1D00h to 1DFAh	250 disturbance data words
1E00h to 1EFAh	250 disturbance data words
1F00h to 1FFAh	250 disturbance data words
2000h to 20FAh	250 disturbance data words
2100h to 21FAh	250 disturbance data words

NB: The disturbance data pages contain values of one channel from one given disturbance record.

Meaning of each value channel

- VA, VB, VC and VN channels:

The value is a signed 16 bits word equivalent to the ADC value

Calculation formula for phase voltage values

Values in Volts can be calculated in following way:

$$\text{Value}_{UA} = \sqrt{2} \cdot \frac{\text{sample_UA} \cdot \text{Internal_PhA} \cdot \text{Phase_Primary_VT_Un}}{\text{Phase_Secondary_VT_Un} \cdot 2000}$$

$$\text{Value}_{UB} = \sqrt{2} \cdot \frac{\text{sample_UB} \cdot \text{Internal_PhB} \cdot \text{Phase_Primary_VT_Un}}{\text{Phase_Secondary_VT_Un} \cdot 2000}$$

$$\text{Value}_{UC} = \sqrt{2} \cdot \frac{\text{sample_UC} \cdot \text{Internal_PhC} \cdot \text{Phase_Primary_VT_Un}}{\text{Phase_Secondary_VT_Un} \cdot 2000}$$

Where:

Internal_PhA, Internal_PhB, Internal_PhC: Internal scaling (Page 38h to 3Ch)

Calculation formula for neutral voltage value

Value in Amps can be calculated in following way:

$$\text{Value}_{UN} = \sqrt{2} \cdot \frac{\text{sample_UN} \cdot \text{Internal_N} \cdot \text{Earth_Primary_VT_Uen}}{\text{Earth_Secondary_VT_Uen} \cdot 2000}$$

Where:

Internal_N: Internal scaling (Page 38h to 3Ch)

- Frequency channel:
Time between two samples in microseconds
- Logic channels:

Logic channel	Contents
---------------	----------

Bit 0	Binary Input 1
Bit 1	Binary Input 2
Bit 2	Binary Input 3
Bit 3	Binary Input 4
Bit 4	Binary Input 5
Bit 5	Binary Input 6
Bit 8	Output RL1
Bit 9	Output RL2
Bit 10	Output RL3
Bit 11	Output RL4
Bit 12	Output RL5
Bit 13	Output RL6
Bit 14	Protection Trip
Bit 15	Start of protection which trips

Page 22h: Disturbance Record Index Frame

Access in word reading (function 03)

Address	Contents
2200h	Disturbance data index frame

Disturbance record index frame

Word	Contents
n° 1	Disturbance record number
n° 2	Disturbance record finish date (second)
n° 3	Disturbance record finish date (second)
n° 4	Disturbance record finish date (millisecond)
n° 5	Disturbance record finish date (millisecond)
n° 6	Disturbance record starting condition: 1: tripping 2: instantaneous 3: remote command 4: logic input
n° 7	Frequency at the post-time beginning

Page 35h (addresses 3500h to 354Ah): event record data (9 words)

- Word n° 1: Event meaning
- Word n° 2: MODBUS associated value
- Word n° 3: MODBUS address
- Word n° 4: Reserved
- Words n° 5 & 6 & 7 & 8: Event date is Inverted IEC 60870-5-4 CP56Time2a:
See format Page 8h

Word n° 9: Acknowledge
 0=event non-acknowledged
 1= event acknowledged)

Code	Meaning of the event	Type	MODBUS address
00	No event	-	
01	CB closing (Remote/menu HMI)	F38 ↑	0400h (bit 15)
02	CB tripping (Remote/menu HMI)	F38 ↑	0400h (bit 7)
03	Reset latched outputs (Remote)	F38 ↑	0400h (bit 2)
04	Reset signaling (Remote)	F38 ↑	0400h (bit 1)
05	Reset signaling and latched outputs (Remote)	F38 ↑	0400h (bit 3)
06	Clear fault and disturbance recorder	F38A ↑	0401h (bit 0)
07	Clear event recorder	F38A ↑	0401h (bit 1)
08	Reserved		
09	Warm restart	↑	-
10	START V>	F37↑↓	0021h (bit 0)
11	START V>>	F37↑↓	0022h (bit 0)
12	START V>>>	F37↑↓	0023h (bit 0)
13	START V<	F37↑↓	0024h (bit 0)
14	START V<<	F37↑↓	0025h (bit 0)
15	START V<<<	F37↑↓	0026h (bit 0)
16	START VN>	F37↑↓	0027h (bit 0)
17	START VN>>	F37↑↓	0028h (bit 0)
18	START VN>>>	F37↑↓	0029h (bit 0)
19	START V1<	F37↑↓	002Ch (bit 0)
20	START V1<<	F37↑↓	002Dh (bit 0)
21	START V2>	F37↑↓	002Ch (bit 0)
22	START V2>>	F37↑↓	002Dh (bit 0)
23	START f1	F37↑↓	002Dh (bit 0)
24	START f2	F30 ↑	001Bh (value 4)
25	START f3	F31A ↑	001Ah (bit 10)
26	START f4	F51 ↑↓	002Ah (bit 0)
27	START f5	F11 ↑↓	0010h
28	START f6	F24 ↑↓	0013h
29	Reserved	F37↑↓	0023h (bit 0)
30	Reserved	F37↑↓	0023h (bit 6)
31	Reserved	F50 ↑↓	002Dh (bit 0)
32	Start Aux1	F50 ↑↓	002Dh (bit 6)
33	Start Aux2	F51 ↑↓	0028 (bit 6)
34	Start Aux3	F51 ↑↓	0029h (bit 6)
35	CB Fail Ext.	F32↑	0009h (bit 0)
36	CB status: opened	F30 ↑	001Bh (value 0)
37	CB status: closed	F30 ↑	001Bh (value 1)

Code	Meaning of the event	Type	MODBUS address
38	CB status: faulty	F30 ↑	001Bh (value 3)
39	CB status: undefined	F30 ↑	001Bh (value 4)
40	tV>	F31 ↑↓	0019h (bit 4)
41	tV>>	F31 ↑↓	0019h (bit 5)
42	tV>>>	F31A ↑↓	0020h (bit 5)
43	tV<	F31A ↑↓	0020h (bit 6)
44	tV<<	F31 ↑↓	0019h (bit 8)
45	tV<<<	F31 ↑↓	0019h (bit 10)
46	tVN>	F51 ↑↓	0027h (bit 0)
47	tVN>>	F51 ↑↓	0028h (bit 0)
48	tVN>>>	F38 ↑	0400h (bit 8)
49	tV1<	F38 ↑	0400h (bit 9)
50	tV1<<	F38 ↑	0400h (bit 5)
51	tV2>		
52	tV2>>		
53	tf1		
54	tf2		
55	tf3	F38A↑	0401h (bit 9)
56	tf4	F38A↑	0401h (bit 5)
57	tf5	F38A↑	0401h (bit 14)
58	tf6	F38A↑	0401h (bit 15)
59	Reserved	↑	
60	Reserved	F38A↑	0401h (bit 3)
61	Reserved		
62	tAUX1		
63	tAUX2		
64	tAUX3	F31A ↑	001Ah (bit 10)
65	tCB Faulty External Signal.	F31A ↑	001Ah (bit 10)
66	CHANGE OF INPUT LOGIC STATE	F11 ↑↓	0010h
67	CHANGE OF OUTPUT LOGIC STATE	F24 ↑↓	0013h
68	Setting Group 1 active	F32↑	0009h (bit 0)
69	Setting Group 2 active	F32↑	0009h (bit 1)
70	tV> Alarm		
71	tV>> Alarm		
72	tV>>> Alarm		
73	tV< Alarm		
74	tV<< Alarm		
75	tV<<< Alarm		
76	tVN> Alarm		
77	tVN>> Alarm		

Code	Meaning of the event	Type	MODBUS address
78	tVN>>> Alarm		
79	tV1< Alarm		
80	tV1<< Alarm		
81	tV2> Alarm		
82	tV2>> Alarm		
83	tf1 Alarm		
84	tf2 Alarm		
85	tf3 Alarm		
86	tf4 Alarm		
87	tf5 Alarm		
88	tf6 Alarm		
89-91	Reserved		
92	tAUX1 Alarm		
93	tAUX2 Alarm		
94	tAUX3 Alarm		
95	Reserved		
96	Local CTRL mode	F61↑	001Eh (value: 2)
97	Remote CTRL mode	F61↑	001Eh (value: 1)
98	Local and remote CTRL mode	F61↑	001Eh (value: 0)
99	Setting change to Group 1 (Remote)	F38↑	0400h (bit 6)
100	Setting change to Group 2 (Remote)	F38↑	0400h (bit 11)
101	Reserved		
102	Setting Group 2 set via Input	F104↑↓	0035h (bit 8)
103	Relays Test (Commissioning Test) active	↑	-
104	Functional test V> ON	↑	-
105	Functional test V> OFF	↑	-
106	Functional test V>> ON	↑	-
107	Functional test V>> OFF	↑	-
108	Functional test V>>> ON	↑	-
109	Functional test V>>> OFF	↑	-
110	Functional test V< ON	↑	-
111	Functional test V< OFF	↑	-
112	Functional test V<< ON	↑	-
113	Functional test V<< OFF	↑	-
114	Functional test V<<< ON	↑	-
115	Functional test V<<< OFF	↑	-
116	Functional test VN> ON	↑	-
117	Functional test VN> OFF	↑	-
118	Functional test VN>> ON	↑	-
119	Functional test VN>> OFF	↑	-

Code	Meaning of the event	Type	MODBUS address
120	Functional test VN>>> ON	↑	-
121	Functional test VN>>> OFF	↑	-
122	Functional test V2> ON	↑	-
123	Functional test V2> OFF	↑	-
124	Functional test V2>> ON	↑	-
125	Functional test V2>> OFF	↑	-
126	Functional test V1< ON	↑	-
127	Functional test V1< OFF	↑	-
128	Functional test f1 ON	↑	-
129	Functional test f1 OFF	↑	-
130	Functional test f2 ON	↑	-
131	Functional test f2 OFF	↑	-
132	Functional test f3 ON	↑	-
133	Functional test f3 OFF	↑	-
134	Voltage Protection disable status	F12↑↓	0011h
135	Protection disable status	F12A↑↓	0012h
136	Blocking tV> active	F37↑↓	0021h (bit 4)
137	Blocking tV>> active	F37↑↓	0022h (bit 4)
138	Blocking tV>>> active	F37↑↓	0023h (bit 4)
139	Blocking tV< active	F37↑↓	0024h (bit 4)
140	Blocking tV<< active	F37↑↓	0025h (bit 4)
141	Blocking tV<<< active	F37↑↓	0026h (bit 4)
142	Blocking tV1< active	F50↑↓	0027h (bit 4)
143	Blocking tV1<< active	F50↑↓	0028h (bit 4)
144	Blocking tV2> active	F50↑↓	0028h (bit 4)
145	Blocking tV2>> active	F50↑↓	002Ch (bit 4)
146	Blocking tVN> active	F50↑↓	002Dh (bit 4)
147	Blocking tVN>> active	F50↑↓	002Ah (bit 4)
148	Blocking tVN>>> active	F50↑↓	002Bh (bit 4)
149	Blocking tf1 active	F50↑↓	0032h (bit 4)
150	Blocking tf2 active	F50↑↓	0033h (bit 4)
151	Blocking tf3 active	F50↑↓	0034h (bit 4)
152	Blocking tf4 active	F50↑↓	0035h (bit 4)
153	Blocking tf5 active	F50↑↓	0036h (bit 4)
154	Blocking tf6 active	F50↑↓	0037h (bit 4)
155	Reserved		
156	Reserved		
157	Reserved		
158	Acknowledgement of the hardware alarm	F38↑	0401h (bit 5)
159	Disable acknowledgment of events	F38↑	0400h (bit 12)

Code	Meaning of the event	Type	MODBUS address
160	Acknowledgment of the oldest event	F38↑	0400h (bit 13)
161	Acknowledgment of the oldest fault	F38↑	0400h (bit 14)
162	Acknowledgment of the oldest disturbance recorder	F38A↑	0401h (bit 8)
163	Disturbance recorder remote start	F38A↑	0401h (bit 5)
164	Fault counter reset	F38A↑	0401h (bit 12)
165	Control counter reset	F38A↑	0401h (bit 13)
166	Maintenance mode	F38A↑	0401h (bit 6)
167	End of maintenance mode	F38A↑	0401h (bit 7)
168	Manual Close via Input	↑	-
169	Manual Close via Function Key	↑	-
170	Manual Trip via Input	↑	-
171	Manual trip via Function Key	↑	-
172	Start Disturbance recorder via Input	↑	-
173	Local CTRL mode via Input active	↑	-
174	Local CTRL mode via HMI or RS485 active	↑	-
175	Administrator password entered	↑	-
176	Protection password entered	↑	-
177	Control password entered	↑	-
178	Reset LEDs and latched outputs via HMI (C key)	↑	-
179	Reset signalling via Input	F104↑	0035h (bit 1)
180	Reset latched outputs via Input	F104↑	0035h (bit 2)
181	Reset signalling on close	↑	-
182	State of CB Alarm	F31A↑↓	001Ah (bit 2)
183	Alarm VTS	↑↓	-
184	f<> internally locked (fOUT)	↑↓	-
185	f<> blocked (Remote/menu HMI)	↑↓	-

Note: The double arrow ↑↓ means the event is generated on event occurrence (↑) and on event disappearance (↓).

On event occurrence, the corresponding bit of the associated format is set to « 1 ».

On event disappearance, the corresponding bit of the associated format is set to « 0 ».

Page 36h

Most older event data

Access in word reading (function 03)

Address	Contents
3600h	Most older event data

Page 37h: Fault Record Value Data

Access in word reading (**function 03**)

Address	Contents
3700h	Fault value record n°1
3701h	Fault value record n°2
3702h	Fault value record n°3
3703h	Fault value record n°4
3704h	Fault value record n°5
3705h	Fault value record n°6
3706h	Fault value record n°7
3707h	Fault value record n°8
3708h	Fault value record n°9
3709h	Fault value record n°10
3710h	Fault value record n°11
3711h	Fault value record n°12
3712h	Fault value record n°13
3713h	Fault value record n°14
3714h	Fault value record n°15
3715h	Fault value record n°16
3716h	Fault value record n°17
3717h	Fault value record n°18
3718h	Fault value record n°19
3719h	Fault value record n°20

Word n° 1: Fault number

Words n° 2 & 3 & 4 & 5: see table below (Inverted IEC 60870-5-4 CP56Time2a)

Timer	Address (hex)	Nb bytes	Mask (hex)	Values range	Unit
	Word n° 2	1 (Hi)			
Year		1 (Lo)	7F	0 – 99 (2000-2099)	Year
Month	Word n° 3	1 (Hi)	0F	1 - 12	month
Day of week		1 (Lo)	E0	Not used in P1V	
day of month		1 (Lo)	1F	1 – 31	Day
Season	Word n° 4	1 (Hi)	80	0 – 1 (summer-winter) Not used	
Hour		1 (Hi)	1F	0-23	Hour
Invalidity		1 (Lo)	80	0 -1 (valid – invalid)	
Minute		1 (Lo)	3F	0-59	Minute
Millisecond pF+pf	Word n° 5	2	FFFF	0 – 59999	ms (included s)

- Word n° 6: Reserved
- Word n° 7: Active setting group during the fault (1 or 2)
- Word n° 8: Fault origin
- 0= none
 - 1= phase A
 - 2= phase B
 - 3= phase C
 - 4= phases A-B
 - 5= phases A-C
 - 6= phases B-C
 - 7= phases A-B-C
 - 8= earth
- Word n° 9: Fault recording starting origin
- Fault nature code meaning

Code [decimal value]	Fault origin
00	Null event
01	tV> trip
02	tV>> trip
03	tV>>> trip
04	tV< trip
05	tV<< trip
06	tV<<< trip
07	tVN> trip
08	tVN>> trip
09	tVN>>> trip
10	tV2> trip
11	tV2>> trip
12	tV1< trip
13	tV1<< trip
14	tf1 trip
15	tf2 trip
16	tf3 trip
17	tf4 trip
18	tf5 trip
19	tf6 trip
20	NOT USED
21	NOT USED
22	NOT USED
23	tAux1 trip
24	tAux2 trip
25	tAux3 trip

Word n° 10:	Fault value voltage (nominal value)	
Word n° 11:	Phase A voltage value (nominal value)	
Word n° 12:	Phase B voltage value (nominal value)	
Word n° 13:	Phase C voltage value (nominal value)	
Word n° 14:	Earth voltage value (nominal value)	
Word n° 15:	Acknowledge of fault	0 : fault non-acknowledged 1 : fault acknowledged

Calculation Formula for Phase Voltage Values

Line phase voltage value (primary value) = phase sampled value (e.g. word 10, 11, 12 or 13) * {line primary VT ratio (address 0120h)/Line VT sec (address 0121h)} V/10

Calculation Formula for Neutral Voltage Value

Neutrale voltage value (primary value) = phase sampled value (e.g. word 10, 11, 12 or 13) * {line primary VT ratio (address 0122h)/Line VT sec (address 0123h)} V/10

Page 3Eh: Most Older Fault Record Value Data

Access in word reading (**function 03**)

Address	Contents
3E00h	Most older Fault record

Page 38h to 3Ch: Disturbance Recorder (A)

Selection of the disturbance record and channel (34 bytes are uploaded for each address reading)

Access in word reading (**function 03**)

Address	Disturbance record number	Format
3800h	1	VA
3801h	1	VB
3802h	1	VC
3803h	1	VN
3804h	1	Frequency
3805h	1	Logic input and outputs
3900h	2	VA
3901h	2	VB
3902h	2	VC
3903h	2	VN
3904h	2	Frequency
3905h	2	Logic input and outputs
3A00h	3	VA

3A01h	3	VB
3A02h	3	VC
3A03h	3	VN
3A04h	3	Frequency
3A05h	3	Logic input and outputs
3B00h	4	VA
3B01h	4	VB
3B02h	4	VC
3B03h	4	VN
3B04h	4	Frequency
3B05h	4	Logic input and outputs
3C00h	5	VA
3C01h	5	VB
3C02h	5	VC
3C03h	5	VN
3C04h	5	Frequency
3C05h	5	Logic input and outputs

- Word n° 1 : Number of samples included in the mapping
- Word n° 2 : Sample number in pre-time
- Word n° 3 : Sample number in post-time
- Word n° 4 : Line VT primary nominal voltage (**Phase_Primary_VT_Un**)
- Word n° 5 : Line VT secondary nominal voltage (**Phase_Secondary_VT_Un**)
- Word n° 6 : E/GND VT primary nominal voltage (**Earth_Primary_VT_Uen**)
- Word n° 7 : E/GND VT secondary nominal voltage (**Earth_Secondary_VT_Uen**)
- Float¹⁾ n° 1 : Phase A Internal PhA ratio (**Internal_PhA**)
- Float¹⁾ n° 2 : Phase B internal PhB ratio (**Internal_PhB**)
- Float¹⁾ n° 3 : Phase C internal PhC ratio (**Internal_PhC**)
- Float¹⁾ n° 4 : Earth internal ratio (**Internal_N**)
- Word n° 8 : Mapping last page number
- Word n° 9 : Number of words in the mapping last page

¹⁾ Float – 4 bytes floating point number

Pages 3Dh: Number of Disturbance Records Available

Access in word reading (function 03)

Address	Contents
3D00h	Number of disturbances records available

- Word n° 1: Number of disturbances records available
- Word n° 2: Oldest disturbance record number (n)
- Words n° 3 & 4: Oldest disturbance record date (second)
- Words n° 5 & 6: Oldest disturbance record date (millisecond)
- Word n° 7: Disturbance record starting origin

	1= Protection trip
	2= instantaneous threshold
	3= remote command
	4= logic input
Word n° 8:	Acknowledge
Word n° 9:	Disturbance record previous number (n+1)
Words n° 10 & 11:	Previous disturbance record date (second)
Words n° 12 & 13:	Previous disturbance record date (millisecond)
Word n° 14:	Disturbance record starting origin
	1= Protection trip
	2= instantaneous threshold
	3= remote command
	4= logic input
Word n° 15:	Acknowledge
Word n° 16:	Disturbance record previous number (n+2)
Words n° 17 & 18:	Previous disturbance record date (second)
Words n° 19 & 20:	Previous disturbance record date (millisecond)
Word n° 21:	Disturbance record starting origin
	1= Protection trip
	2= instantaneous threshold
	3= remote command
	4= logic input
Word n° 22:	Acknowledge
Word n° 23:	Disturbance record previous number (n+3)
Words n° 24 & 25:	Previous disturbance record date (second)
Words n° 26 & 27:	Previous disturbance record date (millisecond)
Word n° 28:	Disturbance record starting origin
	1= Protection trip
	2= instantaneous threshold
	3= remote command
	4= logic input
Word n° 29:	Acknowledge
Word n° 30:	Disturbance record previous number (n+4)
Words n° 31 & 32:	Previous disturbance record date (second)
Words n° 33 & 34:	Previous disturbance record date (millisecond)
Word n° 35:	Disturbance record starting origin
	1= Protection trip
	2= instantaneous threshold
	3= remote command
	4= logic input
Word n° 36:	Acknowledge

Description of the Mapping Format, Easergy P1V

CODE	DESCRIPTION
F1	Unsigned integer – numerical data : 0 – 65535
F10	Characters ASCII byte 1: ASCII character 32-127 byte 2: ASCII character 32-127
F11	Unsigned integer -Binary input status bit 0: logic input 1 (N, A) bit 1: logic input 2 (N, A) bit 2: logic input 3 (A) bit 3: logic input 4 (A) bit 4: logic input 5 (A) bit 5: logic input 6 (A) bit 6-15: reserved
F12	Unsigned integer – Voltage Protection disable status bit 0: V> disabled bit 1: V>> disabled bit 2: V>>> disabled bit 3: V< disabled bit 4: V<< disabled bit 5: V<<< disabled bit 6: VN> disabled bit 7: VN>> disabled bit 8: VN>>> disabled bit 9: V2> disabled (N, A) bit 10: V2>> disabled (N, A) bit 11: V1< disabled (A) bit 12: V1<< disabled (A) bit 13 to 15: reserved
F12A	Unsigned integer – Protection Function disable status bit 0: f1 disabled (A) bit 1: f2 disabled (A) bit 2: f3 disabled (A) bit 3: f4 disabled (A) bit 4: f5 disabled (A) bit 5: f6 disabled (A) bit 6: reserved bit 7: reserved bit 8: reserved bit 9: AUX 1 disabled (A) bit 10: AUX 2 disabled (A) bit 11: AUX 3 disabled (A) bit 12 to 15: reserved
F15	Two-digit decimal number - Firmware version 1st digit - major version 2nd digit - minor version 10: 1A 11: 1B 12: 1C 13: 1D etc.
F16	Unsigned integer – Configuration 0: disabled 1: enable OR Trip 2: enable OR Alarm 3: enable AND Trip 4: enable AND Alarm 5: enable OR Trip/52a (N, A) 6: enable OR Alarm/52a (N, A) 7: enable AND Trip/52a (N, A) 8: enable AND Alarm/52a (N, A)
F17	Unsigned integer - Hardware version 00: 4BO, no RS485 (Model L) 01: 4BO, RS485 (model L with RS485) 10: 2BI, 4BO, no RS485 (Model N) 11: 6BI, 8BO, RS485 (model A)

CODE	DESCRIPTION
F18	Unsigned integer – curves type 0: DT 1: SI IEC 2: VI IEC 3: EI IEC 4: LTI (IEC) 5: STI (IEC) 6: RC Rectifier curve 7: RI curve 8: MI IEEE 9: VI IEEE 10: EI IEEE 11: STI (US C02-P20) 12: LTI (US CO8) 13: RXIDG 14: BPN EDF 15: STI (US C02-P40)
F19	Unsigned integer - Baud rate value 0: 4800 baud 1: 9600 baud 2: 19200 baud 3: 38400 baud 4: 57600 baud 5: 115200 baud
F20	Unsigned integer – Parity 0: none 1: even 2: odd
F21	Unsigned integer – VT secondary 1: 57-130V 2: 220-480V
F22	Unsigned integer – Stop 0: 1 stop 1: 2 stop
F23	Unsigned integer – VT secondary E/Gnd 0: none 1: 57-130V
F24	Unsigned integer - Logical output status bit 0: logic output RL1 bit 1: logic output RL2 bit 2: logic output RL3 bit 3: logic output RL4 bit 4: logic output RL5 bit 5: logic output RL6 bit 6: logic output RL7 bit 7 to 15: reserved
F25	Unsigned integer - Logical LED status bit 0: Trip bit 1: LED2 (Alarm) bit 2: LED3 bit 3: LED4 bit 4: LED5 bit 5: LED6 bit 6: LED7 bit 7: Healthy bit 8-15: reserved
F26	Unsigned integer - Logical healthy status bit 0 to 3: reserved bit 4: Healthy bit 10-15: reserved

CODE	DESCRIPTION
F28	Unsigned integer - Protection start status bit 0: V> bit 1: V>> bit 2: V>>> bit 3: V< bit 4: V<< bit 5: V<<< bit 6: VN> bit 7: VN>> bit 8: VN>>> bit 9: V2> (N, A) bit 10: V2>> (N, A) bit 11: V1< (A) bit 12: V1<< (A) bit 13: starting in phase A bit 14: starting in phase B bit 15: starting in phase C
F28A	Unsigned integer - Protection start status bit 0: f1 (A) bit 1: f2 (A) bit 2: f3 (A) bit 3: f4 (A) bit 4: f5 (A) bit 5: f6 (A) bit 6: reserved bit 7: reserved bit 8: reserved bit 9: AUX1 (N, A) bit 10: AUX2 (N, A) bit 11: AUX3 (A) bit 12 to 15: reserved
F29	Unsigned integer – Protection Function trip status bit 0: tV> trip bit 1: tV>> trip bit 2: tV>>> trip bit 3: tV< trip bit 4: tV<< trip bit 5: tV<<< trip bit 6: tVN> trip bit 7: tVN>> trip bit 8: tVN>>> trip bit 9: tV2> trip (N, A) bit 10: tV2>> trip (N, A) bit 11: tV1< trip (A) bit 12: tV1<< trip (A) bit 13: trip phase A bit 14: trip phase B bit 15: trip phase C
F29A	Unsigned integer - Protection Function trip status bit 0: tf1 trip (A) bit 1: tf2 trip (A) bit 2: tf3 trip (A) bit 3: tf4 trip (A) bit 4: tf5 trip (A) bit 5: tf6 trip (A) bit 6: reserved bit 7: reserved bit 8: reserved bit 9: tAUX1 trip (N, A) bit 10: tAUX2 trip (N, A) bit 11: tAUX3 trip (A) bit 12 to 15: reserved

CODE	DESCRIPTION
F30	Unsigned integer - CB status 0: CB opened 1: CB closed 2: reserved 3: CB position faulty 4: CB position undefined
F31	Unsigned integer (bit)- Protection Alarm status bit 0: tV> alarm bit 1: tV>> alarm bit 2: tV>>> alarm bit 3: tV< alarm bit 4: tV<< alarm bit 5: tV<<< alarm bit 6: tVN> alarm bit 7: tVN>> alarm bit 8: tVN>>> alarm bit 9: tV2> alarm (N, A) bit 10: tV2>> alarm (N, A) bit 11: tV1< alarm (A) bit 12: tV1<< alarm (A) bit 13: alarm phase A bit 14: alarm phase B bit 15: alarm phase C
F31A	Unsigned integer - Alarm Function status bit 0: tf1 alarm (A) bit 1: tf2 alarm (A) bit 2: tf3 alarm (A) bit 3: tf4 alarm (A) bit 4: tf5 alarm (A) bit 5: tf6 alarm (A) bit 6: reserved bit 7: reserved bit 8: reserved bit 9: tAUX1 alarm (A) bit 10: tAUX2 alarm (A) bit 11: tAUX3 alarm (A) bit 12: alarm t CB not healthy (N, A) bit 13: alarm CB (N, A) bit 14: alarm tVTS (N, A) bit 15: alarm VT Supervision (N, A)
F32	Unsigned integer - Setting group 0: Setting group 1 1: Setting group 2
F35	Unsigned integer -Input configuration bit 0: Input L1 bit 1: Input L2 bit 2: Input L3 bit 3: Input L4 bit 4: Input L5 bit 5: Input L6 bit 6-15: reserved
F36	Unsigned integer -Output configuration bit 0: RL1 bit 1: RL2 bit 2: RL3 bit 3: RL4 bit 4: RL5 bit 5: RL6 bit 6: RL7 bit 7-15: reserved

CODE	DESCRIPTION
F37	Unsigned integer: threshold phase information status: bit 0: information threshold exceeded (V>, V>>, V>>>, V<, V<<, V<<<) bit 1: Instantaneous VA bit 2: Instantaneous VB bit 3: Instantaneous VC bit 4: reserved bit 5: Instantaneous information (V>, V>>, V>>>, V<, V<<, V<<<)(after blocking) bit 6: Tripping information (V>, V>>, V>>>, V<, V<<, V<<<) bit 7 to 15: reserved
F38	Unsigned integer - Remote control word 1 bit 0: Warm restart (N, A) bit 1: Reset LEDs (N, A) bit 2: Reset Outputs (N, A) bit 3: Reset LEDs and Outputs (N, A) bit 4: Local Mode (A) bit 5: Reset latched Alarms (N, A) bit 6: Setting change to Group 1 (N, A) bit 7: Remote or HMI CB open order (N, A) bit 8: f<> Remote blocking (A) bit 9: f<> Remote unblocking (A) bit 10: Remote Mode (A) bit 11: Setting change to Group 2 (N, A) bit 12: Disable automatic acknowledgement of events (N, A) bit 13: Oldest event acknowledge (N, A) bit 14: Oldest fault acknowledge (N, A) bit 15: Remote or via HMI CB close order (N, A)
F38A	Unsigned integer - Remote control word 2 bit 0: Clear Recorders (N, A) bit 1: Clear Events (N, A) bit 2: reserved bit 3: reserved bit 4: Peak value reset (N, A) bit 5: Disturbance record remote start (A) bit 6: Maintenance mode (A) bit 7: End of maintenance mode (A) bit 8: Acknowledgement of the oldest disturbance record (A) bit 9: reserved bit 10: reserved bit 11: reserved bit 12: Reset Fault counters (N, A) bit 13: Reset control counters (N, A) bit 14: reserved bit 15: reserved
F38B	Unsigned integer – Remote control word 3 bit 0: reserved bit 1: Enable automatic acknowledgement of events (N, A) bit 2-15: reserved
F39	Unsigned integer - LED function bit 0: LED2 (Alarm) bit 1: LED3 bit 2: LED4 bit 3: LED5 bit 4: LED6 bit 5: LED7 bit 6-15: reserved
F41	Unsigned integer - Curve Type 0: DT 1: IDMT
F49	Unsigned integer - relay status bit 0: Relay status (major alarms) bit 1: Minor hardware alarm bit 2: Presence of non-acknowledged event bit 3: Synchronisation state bit 4: reserved bit 5: Presence of non-acknowledged fault record bit 6-15: reserved

CODE	DESCRIPTION
F50	Unsigned integer: threshold V2, VN, V1, f, AUXx information status: bit 0: information threshold exceeded bit 1: reserved bit 2: reserved bit 3: reserved bit 4: reserved bit 5: Instantaneous information (V2, V1, VN, f, AUXx)(after blockig) bit 6: Tripping information (V2, VN, V1, f, AUXx) bit 7 to 15: reserved
F52	Unsigned integer: information about language in menu 0: English 1: German 2: French 3: Spanish 4: Russian 5: Turkish 6: Regional
F53	Unsigned integer: information about default window in menu 0: Measurements P- P [V] 1: Measurements P-P [Un] 2: Measurements P-N [V] 3: Measurements P-N [Un] 4: Control CB 5: Local mode
F54	Unsigned integer 0: Manual only 1: Protection start 2: Close command
F55	Unsigned integer - Alarm Display Reset 0: Self-Reset 1: Manual Reset
F56	Unsigned integer - Protocol 0: Modbus 1: IEC103
F57	Unsigned integer – Nominal Frequency 0: 50Hz 1: 60Hz
F58	Unsigned integer – Hardware version 0: Standard 1: Model L 2: Model L+RS485 3: Model N 4: Model A
F60	Inverted CP56Time2a Format
F61	Unsigned integer - Local/Remote Mode 0: Local and Remote 1: Remote only 2: Local only
F62	Unsigned integer – Maintenance Mode. Read only (remote modification has no effect) 0: No 1: Yes – output trips 2: Yes – output blocking
F63	Unsigned integer – Configuration 0: No 1: Yes
F64	Unsigned integer – Configuration 0: Protection reset 1: CB Reset

CODE	DESCRIPTION
F65	Unsigned integer – Disturbance recorder configuration 0: On Instantaneous 1: On Trip
F66	Unsigned integer – Configuration 0: Disabled 1: Enabled
F71	Unsigned integer - Number of setting groups: 0: One Group 1: Two Groups
F73	Unsigned integer - Remote Mode configuration 0: Remote Only 1: Remote + Local
F76	Unsigned integer – Functional test pattern 0: V> 1: V>> 2: V>>> 3: V< 4: V<< 5: V<<< 6: VN> 7: VN>> 8: VN>>> 9: V2> (N, A) 10: V2>> (N, A) 11: V1< (A) 12: V1<< (A) 13: f1 (A) 14: f2 (A) 15: f3 (A) 16: f4 (A) 17: f5 (A) 18: f6 (A)
F77	Unsigned integer - Functional Test End 0: CB Trip 1: Time elapsed
F82	Unsigned integer – Control key confirmation 0: without confirmation 1: with confirmation
F84	Unsigned integer - Configuration: 0: disable 1: f> Trip 2: f> Alarm 3: f< Trip 4: f< Alarm
F88	Unsigned integer – IDMT Interlock by DMT 0: No 1: Yes
F90	Unsigned Integer - VT connection 0: 3Upn 1: 3Upn+UN 2: 2Upp+UN 3: 3Upp+UN
F91	Unsigned integer – Protection configuration 0: P-N 1: P-P
F92	Unsigned integer – VTS input 0: VTS input 1: Delta Vr=VN-3Vo 2: Delta Vr=VN-3Vo and VTS input
F94	Unsigned integer - Configuration 0: disabled 1: Trip 2: Alarm

CODE	DESCRIPTION
F95	Unsigned integer - Configuration 0: disable 1: Trip (measured) 2: Alarm (measured) 3: Trip (Ua+Ub+Uc) 4: Alarm (Ua+Ub+Uc)

Request to retrieve the oldest non-acknowledge event

Slave number	Function code	Word address	Word number	CRC
xx	03h	36h 00	00 09h	xx xx

This event request may be answered an error message with the error code:

EVT_EN_COURS_ECRIT (5): An event is being written into the saved FRAM.

Note: On event retrieval, two possibilities exist regarding the event record acknowledgement:

- a) Automatic event record acknowledgement on event retrieval.
- b) Non-automatic event record acknowledgement on event retrieval.

a) Automatic event record acknowledgement on event retrieval:

The bit1 of the remote order frame (format F38B – mapping address 0402h) should be set to 1. On event retrieval, this event record is acknowledged.

b) Non-automatic event record acknowledgement on event retrieval:

The bit12 of the remote order frame (format F38 – mapping address 0400h) should be set to 1. On event retrieval, this event record is not acknowledged. To acknowledge this event, another remote order should be sent to the relay. The bit 13 of this frame (format F38 – mapping address 0400h) should be set to 1.

Request to retrieve a dedicated event

Slave number	Function code	Word address	Word number	CRC
xx	03h	Refer to mapping	00 09h	xx xx

This event request may be answered an error message with the error code:

EVT_EN_COURS_ECRIT (5): An event is being written into the saved FRAM.

Note: This event retrieval does not acknowledge this event.

Modbus request definition used to retrieve the fault records

Two ways can be followed to retrieve a fault record:

- Send a request to retrieve the oldest non-acknowledge fault record.
- Send a request to retrieve a dedicated fault record.

Request to retrieve the oldest non-acknowledge fault record

Slave number	Function code	Word address	Word number	CRC
xx	03h	3Eh 00	00 0Fh	xx xx

Note: On fault retrieval, two possibilities exist regarding the fault record acknowledgement:
 a) Automatic fault record acknowledgement on event retrieval.
 b) Non-automatic fault record acknowledgement on event retrieval.

a) Automatic fault record acknowledgement on fault retrieval:

The bit1 of the remote order frame (format F38B – mapping address 0402h) should be set to 1. On event retrieval, this fault record is acknowledged.

b) Non-automatic fault record acknowledgement on fault retrieval:

The bit12 of the remote order frame (format F38 – mapping address 0400h) should be set to 1. On fault retrieval, this fault record is not acknowledged.

To acknowledge this fault, another remote order should be sent to the relay. The bit 14 of this frame (format F38 – mapping address 0400h) should be set to 1.

Request to retrieve a dedicated fault record

Slave number	Function code	Word address	Word number	CRC
xx	03h	Refer to mapping	00 0Fh	xx xx

Note: This fault value retrieval does not acknowledge this fault record.

IEC 60870-5-103 Interface

The IEC 60870-5-103 interface is a master/slave interface with the relay as the slave device. This protocol is based on the VDEW communication protocol. The relay conforms to compatibility level 2, compatibility level 3 is not supported.

The following IEC 60870-5-103 facilities are supported by this interface:

- Initialization (Reset)
- Time Synchronization
- Event Record Extraction
- General Interrogation
- Cyclic Measurements
- General Commands
- Physical connection and link layer

Physical Connection and Link Layer

Connection is available for IEC 60870-5-103 through the rear RS485 port. It is possible to select both the relay address and baud rate using the front panel interface. Following a change, a reset command is required to re-establish communications.

The parameters of the communication are the following:

- Even Parity
- 8 Data bits
- 1 stop bit
- Data rate 9600 to 115200 bauds

Initialization

Initialization is implemented according to clause 7.4.1 of IEC 60870-5-103.

Whenever the relay has been powered up, or if the communication parameters have been changed a reset command is required to initialize the communications. The relay will respond to either of the two reset commands (Reset CU or Reset FCB), the difference being that the Reset CU will clear any unsent messages in the relay's transmit buffer.

The relay will respond to the reset command with an identification message ASDU 5, the Cause of Transmission COT of this response will be either Reset CU or Reset FCB depending on the nature of the reset command. The following information will be contained in the data section of this ASDU:

Manufacturer Name: EASERGY

According to the specification "Communication Architecture (ACA), Part 4: Communication based on IEC 60870-5-103" (Issue H, April 2010) the Software Identification Section will contain the relay model number and the version number to identify the type of relay.

- byte [0] (device version, decimal): 1 (0 = P1F, 1 = P1V, 2 = P1P)
- byte [1] (firmware major, char): '2', '3', ...

- byte [2] (firmware major, char): 'E', 'F', ...
- byte [3] (firmware version, decimal): 16, 17, ...

In addition to the above identification message, if the relay has been powered up it will also produce a power up event.

Time Synchronization

Time synchronization is implemented according to clause 7.4.2 of IEC 60870-5-103.

The relay time and date can be set using the time synchronization feature of the IEC 60870-5-103 protocol. The relay will correct for the transmission delay as specified in IEC 60870-5-103. If the time synchronization message is sent as a send/confirm message then the relay will respond with a confirm. Whether the time synchronization message is sent as a send confirm or a broadcast (send/no reply) message, a time synchronization message will be returned as Class 1 data.

Spontaneous Events

The events created by the relay will be passed to the master station using the compatible range and the private range of IEC 60870-5-103 function types and information numbers.

Events are categorized using the following information:

Common Address

Function Type

Information number

Below tables contains a complete listing of all events produced by the relay.

General Interrogation

General interrogation is implemented according to clause 7.4.3 of IEC 60870-5-103.

The GI request can be used to read the status of the relay, the function numbers, information numbers and common address offsets that will be returned during the GI cycle are indicated in below tables.

Cyclic Measurements

The relay will produce measured values using ASDU 3 and ASDU 9 on a cyclical basis. They can be read from the relay using a Class 2 poll.

It should be noted that the measurands transmitted by the relay are sent as a proportion of 2.4 times the rated value of the analogue value. The selection of 2.4 for a particular value is indicated in below tables.

Commands

Command transmission is implemented according to clause 7.4.4 of IEC 60870-5-103.

A list of the supported commands is contained in below tables. The relay will respond to all other commands with an ASDU 1, with a cause of transmission (COT) of negative acknowledgement of a command

Blocking of Monitor Direction

The relay does not support a facility to block messages in the Monitor direction.

Spontaneous Messages Managed by Easergy P1V

These messages include a sub-assembly of events which are generated on the relay, because some generated events are not registered in VDEW. They are the most priority messages.

An event is always generated on the rising edge of the information.

Some events can be generated on the rising or lowering edge.

In the list below, events only generated on rising edge will be tagged with a '*'.

The following list of processed events contains the messages for the compatible and the private range for all voltage protection functions, with the associated FUNCTION TYPE, INFORMATION NUMBER, ASDU TYPE, CAUSE OF TRANSMISSION

FUN <160>: Function type in Public range for Voltage Protections (compatible).

FUN <162>, <163>, <164>, <165>, <168>: Function type in Private range (Reserved for Voltage Protections).

Status indications in monitor direction (Type Identification 1)

ASCI	Description	FUN	INF	ASDU	COT	ADDR	Notes
	LEDs and flags indication reset	160	19	1	1,7,11,12, 20, 21	*	
	Reset Latch. Sign Inp	162	223	1	1,7,11,12, 20, 21	*	
	Reset Latched Outputs (Inp+COM)	162	46	1	1,7,11,12, 20, 21	*	
	Reset Latched Signaling. and Outputs (HMI+COM)	249	131	1	1,7,11,12, 20, 21	*	
	Reset Latched Outputs (Inp)	162	86	1	1,7	*	
	Maintenance (Test) Mode Inp	162	157	1	1,7		
	Maintenance Mode (Test Mode)	160	21	1	11		
	Local Mode	160	22	1	11		
	Relay Blocked/faulty (Hardware Warning)	160	47	1	1,7		
	Setting Group number 1	160	23	1	1,7,11,12, 20, 21		
	Setting Group number 2	160	24	1	1,7,11,12, 20, 21		
	Auxiliary input 1	160	27	1	1,7,11		Status of input - it includes reverse logic configuration
	Auxiliary input 2	160	28	1	1,7,11		as above
	Auxiliary input 3	160	29	1	1,7,11		as above
	Auxiliary input 4	160	30	1	1,7,11		as above
	Auxiliary input 5	163	81	1	1,7,11		as above
	Auxiliary input 6	163	82	1	1,7,11		as above
	Input 1	163	160	1	1,7		Presence of the voltage on the input terminals
	Input 2	163	161	1	1,7		as above
	Input 3	163	162	1	1,7		as above
	Input 4	163	163	1	1,7		as above
	Input 5	163	164	1	1,7		as above
	Input 6	163	165	1	1,7		as above

	Relay output 1	249	1	1	1,7		Logical state of the output - before Reverse Logic. Logical state of the output can differ from Physical state - terminals if Reverse Logic for this output is set
	Relay output 2	249	2	1	1,7		as above
	Relay output 3	249	3	1	1,7		as above
	Relay output 4	249	4	1	1,7		as above
	Relay output 5	249	5	1	1,7		as above
	Relay output 6	249	6	1	1,7		as above
	Relay output 7	249	7	1	1,7		as above
	Relay output 8	249	8	1	1,7		as above
	Manual. Trip Ext (Inp)	162	148	1	1,7	*	
	Trip CB Order (Inp+HMI+RS485)	162	9	1	1,7	*	
	Manual. Close Ext (Inp)	162	47	1	1,7	*	
	Manual. Close Command (Inp+HMI)	162	246	1	1,7	*	
	Close CB Order (Inp+HMI+RS485)	162	239	1	1,7	*	
	CB Status 52A Inp	163	253	1	1,7		
	CBM: tCB FLT (faulty) Ext. Alarm	165	45	1	1,7		
	CBM: CB Time Monitoring Alarm	165	46	1	1,7	*	
	CBM: State of CB (not correct) ALARM	165	47	1	1,7		
	FT_RC: Faulty time tag	163	74	1	1,7	*	
59	Blocking tV> Ext (Inp)	163	18	1	1,7		
59	Blocking tV>> Ext (Inp)	163	19	1	1,7		
59	Blocking tV>>> Ext (Inp)	165	67	1	1,7		
27	Blocking tV< Ext (Inp)	163	20	1	1,7		
27	27: Blocking tV<< Ext (Inp)	163	21	1	1,7		
27	Blocking tV<<< Ext (Inp)	165	70	1	1,7		
59N	Blocking tVN> Ext (Inp)	163	22	1	1,7		
59N	Blocking tVN>> Ext (Inp)	163	23	1	1,7		
59N	Blocking tVN>>> Ext (Inp)	165	73	1	1,7		
27D	Blocking tV1< Ext (Inp)	163	26	1	1,7		
27D	Blocking tV1<< Ext (Inp)	163	27	1	1,7		
47	Blocking tV2> Ext (Inp)	163	28	1	1,7		
47	Blocking tV2>> Ext (Inp)	163	29	1	1,7		
81	Blocking tf1 Ext (Inp)	162	4	1	1,7		
81	Blocking tf2 Ext (Inp)	164	5	1	1,7		
81	Blocking tf3 Ext (Inp)	164	6	1	1,7		
81	Blocking tf4 Ext (Inp)	162	7	1	1,7		
81	Blocking tf5 Ext (Inp)	165	76	1	1,7		
81	Blocking tf6 Ext (Inp)	165	79	1	1,7		
81	f Out	165	80	1	1,7		
81	Blocked by V<	164	3	1	1,7		
VTS	VTS Enabled	165	102	1	1,7		
VTS	Start VTS	163	71	1	1,7		
VTS	VTS Ext	165	81	1	1,7		
VTS	tVTS	165	101	1	1,7		

Fault Indications in monitor direction (Type Identification 2)

ASCI	Description	FUN	INF	ASDU	COT	ADDR	Notes
	General Trip	160	68	2	1,7	*	
59	Start / pick-up V>/V>>/V>>> A (-B)	163	32	2	1,7		
59	Start / pick-up V>/V>>/V>>> B (-C)	163	33	2	1,7		
59	Start / pick-up V>/V>>/V>>> C (-A)	163	34	2	1,7		
59	Start / pick-up V>	163	30	2	1,7		
59	tV> elapsed	163	36	2	1,7	*	
59	Trip tV>	165	82	2	1,7	*	
59	Start / pick-up V>>	163	31	2	1,7		
59	tV>> elapsed	163	38	2	1,7	*	
59	Trip tV>>	165	83	2	1,7	*	
59	Start / pick-up V>>>	165	65	2	1,7		
59	tV>>> elapsed	165	66	2	1,7	*	
59	Trip tV>>>	165	84	2	1,7	*	
27	Start / pick-up V</V<</V<<< A (-B)	163	41	2	1,7		
27	Start / pick-up V</V<</V<<< B (-C)	163	42	2	1,7		
27	Start / pick-up V</V<</V<<< C (-A)	163	43	2	1,7		
27	Start / pick-up V<	163	39	2	1,7		
27	tV< elapsed	163	45	2	1,7	*	
27	Trip tV<	165	85	2	1,7	*	
27	Start / pick-up V<<	163	40	2	1,7		
27	tV<< elapsed	163	47	2	1,7	*	
27	Trip tV<<	165	86	2	1,7	*	
27	Start / pick-up V<<<	165	68	2	1,7		
27	tV<<< elapsed	165	69	2	1,7	*	
27	Trip tV<<<	165	87	2	1,7	*	
59N	Start / pick-up VN>	163	49	2	1,7		
59N	tVN> elapsed	163	51	2	1,7	*	
59N	Trip tVN>	165	88	2	1,7	*	
59N	Start / pick-up VN>>	163	50	2	1,7		
59N	tVN>> elapsed	163	52	2	1,7	*	
59N	Trip tVN>>	165	89	2	1,7	*	
59N	Start / pick-up VN>>>	165	71	2	1,7		
59N	tVN>>> elapsed	165	72	2	1,7	*	
59N	Trip signal tVN>>>	165	90	2	1,7	*	
27D	Start / pick-up V1<	163	57	2	1,7		
27D	tV1< elapsed	163	59	2	1,7	*	
27D	Trip signal tV1<	165	91	2	1,7	*	
27D	Start / pick-up V1<<	163	58	2	1,7		
27D	tV1<< elapsed	163	60	2	1,7	*	
27D	Trip signal tV1<<	165	92	2	1,7	*	
47	Start / pick-up V2>	163	62	2	1,7		
47	tV2> elapsed	163	64	2	1,7	*	
47	Trip signal tV2>	165	93	2	1,7	*	
47	Start / pick-up V2>>	163	63	2	1,7		
47	tV2>> elapsed	163	65	2	1,7	*	
47	Trip signal tV2>>	165	94	2	1,7	*	
81	Start / pick-up f1	162	8	2	1,7		
81	tf1 elapsed	165	95	2	1,7	*	
81	Trip signal tf1	164	12	2	1,7	*	
81	Start / pick-up f2	164	13	2	1,7		
81	tf2 elapsed	165	96	2	1,7	*	
81	Trip signal tf2	164	17	2	1,7	*	
81	Start / pick-up f3	164	18	2	1,7		
81	tf3 elapsed	165	97	2	1,7	*	
81	Trip signal tf3	165	22	2	1,7	*	

81	Start / pick-up f4	164	23	2	1,7		
81	tf4 elapsed	165	98	2	1,7	*	
81	Trip signal tf4	165	64	2	1,7	*	
81	Start / pick-up f5	165	74	2	1,7		
81	tf5 elapsed	165	99	2	1,7	*	
81	Trip signal tf5	165	75	2	1,7	*	
81	Start / pick-up f6	165	77	2	1,7		
81	tf6 elapsed	165	100	2	1,7	*	
81	Trip signal tf6	165	78	2	1,7	*	
AUX	Start AUX1	163	93	2	1,7		
AUX	tAUX1 elapsed	163	94	2	1,7		
AUX	Trip tAUX1	165	22	2	1,7	*	
AUX	Start AUX2	163	95	2	1,7		
AUX	tAUX2 elapsed	163	96	2	1,7		
AUX	Trip tAUX2	165	23	2	1,7	*	
AUX	Start AUX3	163	97	2	1,7		
AUX	tAUX3 elapsed	163	98	2	1,7		
AUX	Trip tAUX3	165	24	2	1,7	*	
FT_RC	System disturb. runn	162	241	2	1,7		
FT_RC	Record. in progress	162	220	2	1,7		
FT_RC	Start Distur. Recorder INP+COM	162	172	2	1,7		
FT_RC	Trigger INP	162	22	2	1,7		

Control Indications in Monitor Direction:

CB monitoring: FUN<242>; INF <1>; COT<1, 7,11>, <ADDR>

NOTE: The value of CB monitoring DPI can have 4 stages:

- DPI
- <0000 0000> "Undefined / Between closed and opened"
 - <0000 0001> "opened"
 - <0000 0010> "closed"
 - <0000 0011> "Undefined / Faulty"

List of data contained in General Interrogation

It is given in the answer to the General Interrogation (GI).

Relay state information are Class 1 data, they are systematically sent to the master station, during a General Interrogation.

The list of processed data, following a General Interrogation, is given below: it is a sub-assembly of the spontaneous message list, so like spontaneous messages, these data are generated on rising and lowering edge.

Status Indications (Monitor Direction):

ASCI	Description	FUN	INF	ASDU	COT	ADDR	Notes
	Maintenance (Test) Mode Inp	162	157	1	9		
	Maintenance Mode (Test Mode)	160	21	1	9		
	Local Mode	160	22	1	9		
	Relay Blocked/faulty (Hardware Warning)	160	47	1	9		
	Setting Group number 1	160	23	1	9		
	Setting Group number 2	160	24	1	9		
	Auxiliary input 1 (logical state)	160	27	1	9		Status of input - it includes

							reverse logic configuration
	Auxiliary input 2 (logical state)	160	28	1	9		as above
	Auxiliary input 3 (logical state)	160	29	1	9		as above
	Auxiliary input 4 (logical state)	160	30	1	9		as above
	Auxiliary input 5 (logical state)	163	81	1	9		as above
	Auxiliary input 6 (logical state)	163	82	1	9		as above
	Input 1	163	160	1	9		Presence of the voltage on the input terminals
	Input 2	163	161	1	9		as above
	Input 3	163	162	1	9		as above
	Input 4	163	163	1	9		as above
	Input 5	163	164	1	9		as above
	Input 6	163	165	1	9		as above
	Relay output 1	249	1	1	9		Logical state of the output - before Reverse Logic. Logical state of the output can differ from Physical state - terminals if Reverse Logic for this output is set
	Relay output 2	249	2	1	9		as above
	Relay output 3	249	3	1	9		as above
	Relay output 4	249	4	1	9		as above
	Relay output 5	249	5	1	9		as above
	Relay output 6	249	6	1	9		as above
	Relay output 7	249	7	1	9		as above
	Relay output 8	249	8	1	9		as above
59	Blocking tV> Ext (Inp)	163	18	1	1,7		
59	Blocking tV>> Ext (Inp)	163	19	1	1,7		
59	Blocking tV>>> Ext (Inp)	165	67	1	1,7		
27	Blocking tV< Ext (Inp)	163	20	1	1,7		
27	Blocking tV<< Ext (Inp)	163	21	1	1,7		
27	Blocking tV<<< Ext (Inp)	165	70	1	1,7		
59N	Blocking tVN> Ext (Inp)	163	22	1	1,7		
59N	Blocking tVN>> Ext (Inp)	163	23	1	1,7		
59N	Blocking tVN>>> Ext (Inp)	165	73	1	1,7		
27D	Blocking tV1< Ext (Inp)	163	26	1	1,7		
27D	Blocking tV1<< Ext (Inp)	163	27	1	1,7		
47	Blocking tV2> Ext (Inp)	163	28	1	1,7		
47	Blocking tV2>> Ext (Inp)	163	29	1	1,7		
	CB Status 52A Inp	163	253	1	9		
CBM	tCB FLT (faulty) Ext. Alarm	165	45	1	9		
CBM	State of CB (not correct) ALARM	165	47	1	9		
VTS	VTS Enabled	165	102	1	1,7		
VTS	Start VTS	163	71	1	1,7		
VTS	VTS Ext	165	81	1	1,7		
VTS	tVTS	165	101	1	1,7		

Fault Indications in monitor direction

ASCII	Description	FUN	INF	ASDU	CO9T	ADDR	Notes
59	Start / pick-up V>/V>>/V>>> A (-B)	163	32	2	9		
59	Start / pick-up V>/V>>/V>>> B (-C)	163	33	2	9		
59	Start / pick-up V>/V>>/V>>> C (-A)	163	34	2	9		
59	Start / pick-up V>	163	30	2	9		
59	Start / pick-up V>>	163	31	2	9		
59	Start / pick-up V>>>	165	65	2	9		
27	Start / pick-up V</V<</V<<< A (-B)	163	41	2	9		
27	Start / pick-up V</V<</V<<< B (-C)	163	42	2	9		
27	Start / pick-up V</V<</V<<< C (-A)	163	43	2	9		
27	Start / pick-up V<	163	39	2	9		
27	Start / pick-up V<<	163	40	2	9		
27	Start / pick-up V<<<	165	68	2	9		
59N	Start / pick-up VN>	163	49	2	9		
59N	Start / pick-up VN>>	163	50	2	9		
59N	Start / pick-up VN>>>	165	71	2	9		
27D	Start / pick-up V1<	163	57	2	9		
27D	Start / pick-up V1<<	163	58	2	9		
47	Start / pick-up V2>	163	62	2	9		
47	Start / pick-up V2>>	163	63	2	9		
AUX	Start AUX1	163	93	2	9		
AUX	tAUX1 elapsed	163	94	2	9		
AUX	Start AUX2	163	95	2	9		
AUX	tAUX2 elapsed	163	96	2	9		
AUX	Start AUX3	163	97	2	9		
AUX	tAUX3 elapsed	163	98	2	9		
AUX	Start AUX4	163	99	2	9		
AUX	tAUX4 elapsed	163	100	2	9		
FT_RC	System disturb. runn	162	241	2	9		
FT_RC	Record. in progress	162	220	2	9		
FT_RC	Start Distur. Recorder INP+COM	162	172	2	9		
FT_RC	Trigger INP	162	22	2	9		

Control indications in monitor direction:

CB monitoring: FUN<242>; INF <1>; COT<9>, <ADDR>

NOTE: The value of CB monitoring DPI can have 4 stages:

DPI
 <0000 0000> "Undefined / Between closed and opened"
 <0000 0001> "opened"
 <0000 0010> "closed"
 <0000 0011> "Undefined / Faulty"

Processed Commands

System Commands

Synchronization Command (ASDU 6): FUN<255>, INF <0>; TYP <6>; COT<8>

This command can be sent to a specific relay, or global. The time sent by master is the time of the first bit of the frame. The relay synchronizes with this time, corrected by the frame transmission delay. After updating its time, the relay sends back an acknowledge to the master, by giving its new current time.

This acknowledge message will be an event of ASDU 6 type.

General Interrogation Initialization command (ASDU 7):

FUN<255>; INF <0>; TYP <7>; COT<9>

This command starts the relay interrogation:

The relay then sends a list of data containing the relay state (see list described above).

The GI command contains a scan number which will be included in the answers of the GI cycle generated by the GI command.

If a data has just changed before extracted by the GI, the new state is sent to the master station.

When an event is generated during the GI cycle, the event is sent in priority, and the GI cycle is temporarily interrupted. The end of the GI consists in sending an ASDU 8 to the master station.

If, during a General Interrogation cycle, another GI Initialization command is received, the precedent answer is stopped, and the new GI cycle started.

General Commands (ASDU 20) (Control direction): Availability

LED Reset and Sign. reset:

This command reset LEDs, signaling:

FUN<160>; INF<19>, TYP<20>, COT <20>, <ADDR>

In LED Reset control command, the allowed value is:

DCO <0000 0010> "Reset"

Output Reset:

This command reset Latched Outputs:

FUN<162>; INF<46>, TYP<20>, COT <20>, <ADDR>

In Latched Outputs Reset control command the allowed value is:

DCO <0000 0010> "Reset"

Setting group number 1: FUN<160>; INF<23>, TYP<20>, COT <20>, <ADDR>

In Setting group number 1 control command the allowed value is:

DCO <0000 0010> "Set Group 1"

Setting group number 2: FUN<160>; INF<24>, TYP<20>, COT <20>, <ADDR>

In Setting group number 2 control command the allowed value is:

DCO <0000 0010> "Set Group 2"

Reset Latched Signaling and Outputs: FUN<249>; INF <131>; COT<20>, <ADDR>

Note: *Reset Latched Signaling and Outputs* is used for command and indication (see: **Status indications in monitor direction Type Identification**).

Reset via RS485 the allowed value is:

DCO <0000 0001> "OFF"

DCO <0000 0010> "ON"

CB control Open command: FUN<242>; INF <65>; TYP <20>; COT<20>, <ADDR>

In CB control command the DCO allowed values are:

DCO <0000 0001> "OFF": "Close CB"

<0000 0010> "ON": "Open CB"

CB control Close command FUN<242>; INF <66>; TYP <20>; COT<20>, <ADDR>

In CB control command the DCO allowed values are:

DCO <0000 0001> "OFF": "Open CB"

<0000 0010> "ON": "Close CB"

General commands are processed according to clause 7.4.4 of IEC 60870-5-103.

After executing one of these commands, the relay sends a positive or negative acknowledge message, which contains the result of command execution.

If a state change is the consequence of the command, it must be sent in an ASDU 1 with COT 12 (remote operation).

If the relay receives another command message from the master station before sending the acknowledge message for the previous command, it will be discarded and a negative acknowledge message will be sent.

Commands which are not processed by the relay are rejected with a negative acknowledge message.

Relay re initialization

In case of relay re initialization, the relay send to the master station:

- a message indicating relay start/restart (FUN<160>;INF<5> ; TYP<5> COT<5>)
- or a message indicating Reset CU (FUN<160>;INF<5> ; TYP<3> COT<4>)
- or a message indicating Reset FCB (FUN<160>;INF<5> ; TYP<2> COT<3>)

Each identification message of the relay (ASDU 5) contains the manufacturer name in 8 ASCII characters ("Easergy ") and 4 free bytes containing:

- byte [0] (device version, decimal): 1 (0 = P1F, 1 = P1V, 2 = P1P)
- byte [1] (firmware major, char): '2', '3', ...
- byte [2] (firmware major, char): 'E', 'F', ...
- byte [3] (firmware version, decimal): 16, 17, ...

Cyclic Messages (ASDU9 and ASDU3)

Only measurements can be stored in these messages.

The measured values are stored in lower levels of communication, before polling by master station.

Va(ab), Vb(bc), Vc(ca) are transmitted with ASDU 9 (FUN<160>,INF<148>).

VN is transmitted with ASDU 3(FUN<160>,INF<147>).

All other measurementss are unused in ASDU 3 and ASDU 9.

The values are stored with a rate of $2,4 * \text{nominal value} = 4096$.

Characteristics

Function Characteristics

General Characteristics

In the tables below:

- A full explanation is given in the reference conditions (IEC 60255-6).

VT Transformation Ratio

Voltage transformer	Characteristic	Values
Phase/Line VT	Primary rated voltage	0.05...65 kV
	Primary Step	0.01 kV
	Secondary rated voltage	57... 130 V (hardware op. 1) 220... 480 V (hardware op. 2)
	Secondary Step	0.1 V
Earth/Neutral VT	Primary rated voltage	0.05...65 kV
	Primary Step	0.01 kV
	Secondary rated voltage	57... 130 V (step: 0.1 V)
	Secondary Step	0.1 V

Phase Voltages

Characteristic	Values
Measuring range	(5 ÷ 200) Vph-ph (for hardware op. 1) (20 ÷ 720) Vph-ph (for hardware op. 2)
Accuracy	± (2% of rdg + 2 digits) ¹
Unit	V
Display refresh period	0.5 s

1. rdg: reading (the read-in value)
digit: the smallest value that can be displayed

Earth/Neutral Voltage

Characteristic	Values
Measuring range	(5 ÷ 135) Vac
Accuracy	± (2% of rdg + 2 digits) ¹
Unit	V
Display refresh period	0.5 s

1. rdg: reading (the read-in value)
digit: the smallest value that can be displayed

Frequency

Characteristic	Values
Measuring range	(40 ÷ 60) Hz (50 ÷ 70) Hz
Accuracy	±10 mHz
Unit	Hz
Display refresh period	0.5 s

Overvoltage Protection

Glossary

- Vmax : max (Va, Vb, Vc)
- Vs : setting value for V>, V>>, V>>>, V<, V<<, V<<<
- V1s : setting value for V1<, V1<<
- V2s : setting value for V2>, V2>>
- fs : setting value for f1, f2, f3, f4, f5, f6
- Ves : setting value for VN>, VN>>, VN>>>

Characteristic of the V> Set Point			Values	
V>?			Disabled OR Trip OR Alarm AND Trip AND Alarm OR Trip/52a (N, A) OR Alarm/52a (N, A) AND Trip/52a (N, A) AND Alarm/52a (N, A)	
Tripping curve			DT IEC_SI IEC_VI IEC_EI IEC_LTI UK_STI RECT RI IEEE_MI IEEE_VI IEEE_EI CO2_Px20 US_CO8 RXIDG BPN_EDF CO2_Px40	
V> Threshold	DMT	57..130 V	Setting range	5... 200 V (step: 0.1 V)
			Accuracy	Vs ± (2%Vs+0.5 V)
			Drop off	Settable: (0.8 – 1.00) Vs ± (2%Vs+0.5 V)
	DMT	220 480 V	Setting range	20... 720 V (step: 0.1 V)
			Accuracy	Vs ± (2%Vs+2.0 V)
			Drop off	Settable: (0.8 – 1.00) Vs ± (2%Vs+2.0 V)
	IDMT	57..130 V	Setting range	5... 200 V (step: 0.1 V)
			Accuracy	1.1 Vs ± (2%Vs)
			Drop off	1.05 Vs ± (2%Vs)
	IDMT	220 480 V	Setting range	20... 720 V (step: 0.1 V)
			Accuracy	1.1 Vs ± (2%Vs)
			Drop off	1.05 Vs ± (2%Vs)
tV> /TMS/TD	DMT		Setting range	0.02... 200 s (step: 0.01 s)
			Accuracy	± (2%+60 ms)*
	IDMT TMS**		Setting range	0.02... 1.5 s (step: 0.01 s)
			Accuracy	± (4%+40 ms)***
	IDMT TD**		Setting range	0.02... 100 s (step: 0.01 s)
			Accuracy	± (4%+40 ms)

*During investigation of operation time - injection voltage must be 2 times greater than setting value.

**If TMS/TD value is selected in eSetup EasergyPro from out of defined range then TMS/TD is set on 1.

***According to standard IEC 60255-151. For UK Rectifier (RC) characteristic: ±(12% + 40 ms).

Characteristic of the V>> Set Point				Values
V>>?				Disabled OR Trip OR Alarm AND Trip AND Alarm OR Trip/52a (N, A) OR Alarm/52a (N, A) AND Trip/52a (N, A) AND Alarm/52a (N, A)
Tripping curve				DT
V>> Threshold	DMT	57...130 V	Setting range	5... 200 V (step: 0.1 V)
			Accuracy	$V_s \pm (2\%V_s+0.5 V)$
			Drop off	Settable: (0.8 – 1.00) $V_s \pm (2\%V_s+0.5 V)$
	DMT	220..480 V	Setting range	20... 720 V (step: 0.1 V)
			Accuracy	$V_s \pm (2\%V_s+2.0 V)$
			Drop off	Settable: (0.8 – 1.00) $V_s \pm (2\%V_s+2.0 V)$
tV>	DMT	Setting range	0.02... 200 s (step: 0.01 s)	
		Accuracy	$\pm (2\%+60 ms)^*$	

*During investigation of operation time - injection voltage must be 2 times greater than setting value.

Characteristic of the V>>> Set Point				Values
V>>>?				Disabled OR Trip OR Alarm AND Trip AND Alarm OR Trip/52a (N, A) OR Alarm/52a (N, A) AND Trip/52a (N, A) AND Alarm/52a (N, A)
Tripping curve				DT
V>>> Threshold	DMT	57...130 V	Setting range	5... 200 V (step: 0.1 V)
			Accuracy	$V_s \pm (2\%V_s+0.5 V)$
			Drop off	Settable: (0.8 – 1.00) $V_s \pm (2\%V_s+0.5 V)$
	DMT	220..480 V	Setting range	20... 720 V (step: 0.1 V)
			Accuracy	$V_s \pm (2\%V_s+2.0 V)$
			Drop off	Settable: (0.8 – 1.00) $V_s \pm (2\%V_s+2.0 V)$
tV>>>	DMT	Setting range	0.02... 200 s (step: 0.01 s)	
		Accuracy	$\pm (2\%+60 ms)^*$	

*During investigation of operation time - injection voltage must be 2 times greater than setting value.

Undervoltage Protection

Characteristic of the V< Set Point			Values	
V<?			Disabled OR Trip OR Alarm AND Trip AND Alarm OR Trip/52a (N, A) OR Alarm/52a (N, A) AND Trip/52a (N, A) AND Alarm/52a (N, A)	
Tripping curve			DT IEC_SI IEC_VI IEC_EI IEC_LTI UK_STI RECT RI IEEE_MI IEEE_VI IEEE_EI CO2_Px20 US_CO8 RXIDG BPN_EDF CO2_Px40	
V< Threshold	DMT	57..130 V	Setting range	5... 130 V (step: 0.1 V)
			Accuracy	Vs ± (2%Vs+0.5 V)
			Drop off	Settable: (1.00 – 1.20) Vs ± (2%Vs+0.5 V)
	DMT	220 480 V	Setting range	20... 480 V (step: 0.1 V)
			Accuracy	Vs ± (2%Vs+2.0 V)
			Drop off	Settable: (1.00 – 1.20) Vs ± (2%Vs+2.0 V)
	IDMT	57..130 V	Setting range	5... 200 V (step: 0.1 V)
			Accuracy	0.9 Vs ± (2%Vs)
			Drop off	0.95 Vs ± (2%Vs)
	IDMT	220 480 V	Setting range	20... 720 V (step: 0.1 V)
			Accuracy	0.9 Vs ± (2%Vs)
			Drop off	0.95 Vs ± (2%Vs)
tV< /TMS/TD	DMT	Setting range	0.02... 200 s (step: 0.01 s)	
		Accuracy	± (2%+60 ms)*	
	IDMT TMS**	Setting range	0.02... 1.5 s (step: 0.01 s)	
		Accuracy	± (4%+40 ms)***	
	IDMT TD**	Setting range	0.02... 100 s (step: 0.01 s)	
		Accuracy	± (4%+40 ms)	

*During investigation of operation time - injection voltage must be 2 times lower than setting value.

**If TMS/TD value is selected in eSetup EasergyPro from out of defined range then TMS/TD is set on 1.

***According to standard IEC 60255-151. For UK Rectifier (RC) characteristic: ±(12% + 40 ms).

Characteristic of the V<< Set Point				Values
V<<?				Disabled OR Trip OR Alarm AND Trip AND Alarm OR Trip/52a (N, A) OR Alarm/52a (N, A) AND Trip/52a (N, A) AND Alarm/52a (N, A)
Tripping curve				DT
V<< Threshold	DMT	57..130 V	Setting range	5... 130 V (step: 0.1 V)
			Accuracy	Vs ± (2%Vs+0.5 V)
			Drop off	Settable: (1.00 – 1.20) Vs ± (2%Vs+0.5 V)
	DMT	220 480 V	Setting range	20... 480 V (step: 0.1 V)
			Accuracy	Vs ± (2%Vs+2.0 V)
			Drop off	Settable: (1.00 – 1.20) Vs ± (2%Vs+2.0 V)
tV<<	DMT	Setting range	0.02... 200 s (step: 0.01 s)	
		Accuracy	± (2%+60 ms)*	

*During investigation of operation time - injection voltage must be 2 times lower than setting value.

Characteristic of the V<<< Set Point				Values
V<<<?				Disabled OR Trip OR Alarm AND Trip AND Alarm OR Trip/52a (N, A) OR Alarm/52a (N, A) AND Trip/52a (N, A) AND Alarm/52a (N, A)
Tripping curve				DT
V<<< Threshold	DMT	57..130 V	Setting range	5... 130 V (step: 0.1 V)
			Accuracy	Vs ± (2%Vs+0.5 V)
			Drop off	Settable: (1.00 – 1.20) Vs ± (2%Vs+0.5 V)
	DMT	220 480 V	Setting range	20... 480 V (step: 0.1 V)
			Accuracy	Vs ± (2%Vs+2.0 V)
			Drop off	Settable: (1.00 – 1.20) Vs ± (2%Vs+2.0 V)
tV<<<	DMT	Setting range	0.02... 200 s (step: 0.01 s)	
		Accuracy	± (2%+60 ms)*	

*During investigation of operation time - injection voltage must be 2 times lower than setting value.

Earth Fault Overvoltage Protection

Characteristic of the VN> Set Point			Values			
VN>?			Disabled Trip (measured) (N, A) Alarm (measured) (N, A) Trip (Va+Vb+Vc) Alarm (Va+Vb+Vc)			
Tripping curve			DT IEC_SI IEC_VI IEC_EI IEC_LTI UK_STI RECT RI IEEE_MI IEEE_VI IEEE_EI CO2_Px20 US_CO8 RXIDG BPN_EDF CO2_Px40			
VN> Threshold	DMT	0.5...130 V	Setting range	0.5... 130 V (step: 0.1 V)		
			Accuracy	<ul style="list-style-type: none"> • Measurement • Calculated 	Ves ± (2%Ves+0.5 V) Ves ± (3%Ves+1.0 V)	
				Drop off	<ul style="list-style-type: none"> • Measurement • Calculated 	0.95 Ves ± (2%Ves+0.5 V) 0.95 Ves ± (3%Ves+1.0 V)
				DMT	20...720 V	Setting range
				Accuracy	<ul style="list-style-type: none"> • Calculated 	Vs ± (3%Vs+4.0 V)
				Drop off	0.95 Vs ± (3%Vs+4.0 V)	
	IDMT	0.5...130 V		Setting range	0.5... 130 V (step: 0.1 V)	
				Accuracy	<ul style="list-style-type: none"> • Measurement • Calculated 	1.1 Ves ± (2%Ves) 1.1 Ves ± (3%Ves)
				Drop off	<ul style="list-style-type: none"> • Measurement • Calculated 	1.05 Vs ± (2%Vs) 1.05 Vs ± (3%Vs)
				IDMT	220 480 V	Setting range
				Accuracy	<ul style="list-style-type: none"> • Calculated 	1.05 Vs ± (3%Vmax)
				Drop off	1.05 Vs ± (3%Vmax)	
tVN> /TMS/TD	DMT		Setting range	0.02... 200 s (step: 0.01 s)		
			Accuracy	<ul style="list-style-type: none"> • Measurement • Calculated 	± (2%+60 ms)* ± (3%+60 ms)*	
	IDMT TMS**		Setting range	0.02... 1.5 s (step: 0.01 s)		
			Accuracy	<ul style="list-style-type: none"> • Measurement • Calculated 	± (4%+40 ms)*** ± (7%+60 ms)***	
	IDMT TD**		Setting range	0.02... 100 s (step: 0.01 s)		
			Accuracy	<ul style="list-style-type: none"> • Measurement • Calculated 	± (4%+40 ms) ± (7%+60 ms)	

*During investigation of operation time - injection voltage must be 2 times greater than setting value.

**If TMS/TD value is selected in eSetup EasergyPro from out of defined range then TMS/TD is set on 1.

***According to standard IEC 60255-151. For UK Rectifier (RC) characteristic: ±(12% + 40 ms).

Characteristic of the VN>> Set Point				Values
VN>>?				Disabled Trip (measured) (N, A) Alarm (measured) (N, A) Trip (Va+Vb+Vc) Alarm (Va+Vb+Vc)
Tripping curve				DT
VN>> Threshold	DMT	0.5...130 V	Setting range	0.5... 130 V (step: 0.1 V)
			Accuracy • Measurement • Calculated	Ves ± (2%Ves+0.5 V) Ves ± (3%Ves+1.0 V)
			Drop off • Measurement • Calculated	0.95 Ves ± (2%Ves+0.5 V) 0.95 Ves ± (3%Ves+1.0 V)
	DMT	20...720 V	Setting range	20... 720 V (step: 0.1 V)
			Accuracy • Calculated	Vs ± (3%Vs+4.0 V)
			Drop off	0.95 Vs ± (3%Vs+4.0 V)
tVN>>	DMT		Setting range	0.02... 200 s (step: 0.01 s)
			Accuracy • Measurement • Calculated	± (2%+60 ms)* ± (3%+60 ms)*

*During investigation of operation time - injection volatge must be 2 times greater than setting value.

Characteristic of the VN>>> Set Point				Values
VN>>>?				Disabled Trip (measured) (N, A) Alarm (measured) (N, A) Trip (Va+Vb+Vc) Alarm (Va+Vb+Vc)
Tripping curve				DT
VN>>> Threshold	DMT	0.5...130 V	Setting range	0.5... 130 V (step: 0.1 V)
			Accuracy • Measurement • Calculated	Ves ± (2%Ves+0.5 V) Ves ± (3%Ves+1.0 V)
			Drop off • Measurement • Calculated	0.95 Ves ± (2%Ves+0.5 V) 0.95 Ves ± (3%Ves+1.0 V)
	DMT	20...720 V	Setting range	20... 720 V (step: 0.1 V)
			Accuracy • Calculated	Vs ± (3%Vs+4.0 V)
			Drop off	0.95 Vs ± (3%Vs+4.0 V)
tVN>>>	DMT		Setting range	0.02... 200 s (step: 0.01 s)
			Accuracy • Measurement • Calculated	± (2%+60 ms)* ± (3%+60 ms)*

*During investigation of operation time - injection volatge must be 2 times greater than setting value.

Negative Sequence Overvoltage Protection

Characteristic of the V2> Set Point				Values
V2>?				Disabled OR Trip OR Alarm AND Trip AND Alarm
Tripping curve				DT IEC_SI IEC_VI IEC_EI IEC_LTI UK_STI RECT RI IEEE_MI IEEE_VI IEEE_EI CO2_Px20 US_CO8 RXIDG BPN_EDF CO2_Px40
V2> Threshold	DMT	57..130 V	Setting range	5... 200 V (step: 0.1 V)
			Accuracy	$V2s \pm (2\%V_{max}+0.5 V)$
			Drop off	$0.95 V2s \pm (2\%V_{max}+0.5 V)$
	DMT	220 480 V	Setting range	20... 720 V (step: 0.1 V)
			Accuracy	$V2s \pm (2\%V_{max}+2.0 V)$
			Drop off	$0.95 V2s \pm (2\%V_{max}+2.0 V)$
	IDMT	57..130 V	Setting range	5... 200 V (step: 0.1 V)
			Accuracy	$1.1 V2s \pm (3\%V_{max})$
			Drop off	$1.05 V2s \pm (3\%V_{max})$
	IDMT	220 480 V	Setting range	20... 720 V (step: 0.1 V)
			Accuracy	$1.1 V2s \pm (3\%V_{max})$
			Drop off	$1.05 V2s \pm (3\%V_{max})$
tV2> /TMS/TD	DMT		Setting range	0.02... 200 s (step: 0.01 s)
			Accuracy	$\pm (2\%+60 ms)^*$
	IDMT TMS**		Setting range	0.02... 1.5 s (step: 0.01 s)
			Accuracy	$\pm (4\%+40 ms)^{***}$
	IDMT TD**		Setting range	0.02... 100 s (step: 0.01 s)
			Accuracy	$\pm (4\%+40 ms)$

*During investigation of operation time - injection voltage must be 2 times greater than setting value.

**If TMS/TD value is selected in eSetup EasergyPro from out of defined range then TMS/TD is set on 1.

***According to standard IEC 60255-151. For UK Rectifier (RC) characteristic: $\pm(12\% + 40 ms)$.

Characteristic of the V2>> Set Point				Values
V2>>?				Disabled OR Trip OR Alarm AND Trip AND Alarm
Tripping curve				DT
V2>> Threshold	DMT	57..130 V	Setting range	5... 200 V (step: 0.1 V)
			Accuracy	$V2s \pm (2\%V_{max}+0.5 V)$
			Drop off	$0.95 V2s \pm (2\%V_{max}+0.5 V)$
	DMT	220 480 V	Setting range	20... 720 V (step: 0.1 V)
			Accuracy	$V2s \pm (2\%V_{max}+2.0 V)$
			Drop off	$0.95 V2s \pm (2\%V_{max}+2.0 V)$
tV2>>	DMT		Setting range	0.02... 200 s (step: 0.01 s)
			Accuracy	$\pm (2\%+60 ms)^*$

*During investigation of operation time - injection voltage must be 2 times greater than setting value.

Positive Sequence Undervoltage Protection

Characteristic of the V1< Set Point				Values
V1<?				Disabled OR Trip OR Alarm AND Trip AND Alarm
Tripping curve				DT IEC_SI IEC_VI IEC_EI IEC_LTI UK_STI RECT RI IEEE_MI IEEE_VI IEEE_EI CO2_Px20 US_CO8 RXIDG BPN_EDF CO2_Px40
V1< Threshold	DMT	57..130 V	Setting range	5... 130 V (step: 0.1 V)
			Accuracy	V2s ± (3%Vmax+0.5 V)
			Drop off	1.05 V1s ± (3%Vmax+0.5 V)
	DMT	220 480 V	Setting range	20... 480 V (step: 0.1 V)
			Accuracy	V1s ± (3%Vmax+2.0 V)
			Drop off	0.95 V1s ± (3%Vmax+2.0 V)
	IDMT	57..130 V	Setting range	5... 130 V (step: 0.1 V)
			Accuracy	0.9 V1s ± (3%Vmax)
			Drop off	0.95 V1s ± (3%Vmax)
	IDMT	220 480 V	Setting range	20... 480 V (step: 0.1 V)
			Accuracy	0.9 V1s ± (3%Vmax)
			Drop off	0.95 V1s ± (3%Vmax)
tV1< /TMS/TD	DMT		Setting range	0.02... 200 s (step: 0.01 s)
			Accuracy	± (2%+60 ms)*
	IDMT TMS**		Setting range	0.02... 1.5 s (step: 0.01 s)
			Accuracy	± (4%+40 ms)***
	IDMT TD**		Setting range	0.02... 100 s (step: 0.01 s)
			Accuracy	± (4%+40 ms)

*During investigation of operation time - injection voltage must be 2 times lower than setting value.

**If TMS/TD value is selected in eSetup EasergyPro from out of defined range then TMS/TD is set on 1.

***According to standard IEC 60255-151. For UK Rectifier (RC) characteristic: ±(12% + 40 ms).

Characteristic of the V1<< Set Point				Values
V1<<?				Disabled OR Trip OR Alarm AND Trip AND Alarm
Tripping curve				DT
V1<< Threshold	DMT	57..130 V	Setting range	5... 130 V (step: 0.1 V)
			Accuracy	V2s ± (3%Vmax+0.5 V)
			Drop off	1.05 V1s ± (3%Vmax+0.5 V)
	DMT	220 480 V	Setting range	20... 480 V (step: 0.1 V)
			Accuracy	V1s ± (3%Vmax+2.0 V)
			Drop off	0.95 V1s ± (3%Vmax+2.0 V)
tV1<<	DMT		Setting range	0.02... 200 s (step: 0.01 s)
			Accuracy	± (2%+60 ms)*

*During investigation of operation time - injection voltage must be 2 times lower than setting value.

External Trip (Auxiliary Timers) Protection

Characteristics		Values
AUX1? AUX2? AUX3?		Disabled, Trip, Alarm
Tripping curve		DMT
Time delay tAUX1? tAUX2? tAUX3	Setting range	0.0... 600 s (step: 0.01 s)
	Accuracy	± (2%+55 ms)*

*During investigation of operation time - injection voltage must be 2 times greater than setting value.

Frequency Protection

Characteristic of the f1, f2, f3, f4, f5, f6 Set Point				Values
f1 ? f2 ? f3 ? f4 ? f5 ? f6 ?				Disabled f > Trip f > Alarm f < Trip f < Alarm
Tripping curve				DT
f1 Threshold f2 Threshold f3 Threshold f4 Threshold f5 Threshold f6 Threshold	DMT	57...130 V V>57 V	Setting range	40...60 Hz (step: 0.01 Hz) at 50 Hz 50...70 Hz (step: 0.01 Hz) at 70 Hz
			Accuracy	fs ± (10 mHz)
			Drop off	For overfrequency (fs - 50 mHz) ± (10 mHz) For underfrequency (fs + 50 mHz) ± (10 mHz)
	DMT	57...130 V V<57 V	Setting range	40...60 Hz (step: 0.01 Hz) at 50 Hz 50...70 Hz (step: 0.01 Hz) at 70 Hz
			Accuracy	fs ± (50 mHz)
			Drop off	For overfrequency (fs - 50 mHz) ± (40 mHz) For underfrequency (fs + 50 mHz) ± (40 mHz)
	DMT	220...480 V V>220 V	Setting range	40...60 Hz (step: 0.01 Hz) at 50 Hz 50...70 Hz (step: 0.01 Hz) at 70 Hz
			Accuracy	fs ± (10 mHz)
			Drop off	For overfrequency (fs - 50 mHz) ± (10 mHz) For underfrequency (fs + 50 mHz) ± (10 mHz)
	DMT	220...480 V V<220 V	Setting range	40...60 Hz (step: 0.01 Hz) at 50 Hz 50...70 Hz (step: 0.01 Hz) at 70 Hz
			Accuracy	fs ± (50 mHz)
			Drop off	For overfrequency (fs - 50 mHz) ± (40 mHz) For underfrequency (fs + 50 mHz) ± (40 mHz)
tf1 tf2 tf3 tf4 tf5 tf6	DMT	Setting range	0.1...600 s (step: 0.01 s)	
		Accuracy	± (2%+25 ms)	

Default Settings

Overvoltage Protection

Menu Text	Default Setting
V> ?	Disabled*
V> Threshold	20 V 20 V
V> Delay Type	DT
tV> /TMS/TD	0.02 s
V> Reset Delay Type	DT High State
V> DMT tReset	0 s
V>> ?	Disabled*
V>> Threshold	40 V 40 V
tV>>	0.02 s
V>>> ?	Disabled*
V>>> Threshold	50 V 50 V
tV>>>	0.02 s

*If the stage/function is disabled all settings concerning this stage/function in the menu cells are hidden.

IDMT tripping can be blocked if any DMT stage is started, settings: **IDMT interlock by DMT (GLOBAL SETTINGS/O/V ADVANCED** column). This settings is common for **E/Gnd Fault O/V [59N], Phase O/V [59]** and **Phase U/V [27]**

Menu Text	Default Setting
IDMT interlock by DMT stage	No
[27] Hysteresis	1.05
[59] Hysteresis	0.95

Undervoltage Protection

Menu Text	Default Setting
V< ?	Disabled*
V< Threshold	20 V 20 V
V< Delay Type	DT
tV< /TMS/TD	0.02 s
V< Reset Delay Type	DT High State
V< DMT tReset	0 s
V<< ?	Disabled*
V<< Threshold	40 V 40 V

Menu Text	Default Setting
tV<<	0.02 s
V<<< ?	Disabled*
V<<< Threshold	50 V 50 V
tV<<<	0.02 s

*If the stage/function is disabled all settings concerning this stage/function in the menu cells are hidden.

Earth Fault Overvoltage Protection

Menu Text	Default Setting
VN> ?	Disabled*
VN> Threshold	5 V
VN> Delay Type	DT
tVN> /TMS/TD	0.02 s
VN> Reset Delay Type	DT High State
VN> DMT tReset	0 s
VN>> ?	Disabled*
VN>> Threshold	10 V
tVN>>	0.02 s
VN>>> ?	Disabled*
VN>>> Threshold	15 V
tVN>>>	0.02 s

*If the stage/function is disabled all settings concerning this stage/function in the menu cells are hidden.

Negative Sequence Overvoltage Protection

Menu Text	Default Setting
V2> ?	Disabled*
V2> Threshold	20 V 20 V
V2> Delay Type	DT
tV2>/TMS/TD	0.02 s
V2> Reset Delay Type	DT High State
V2> DMT tReset	0 s
V2>> ?	Disabled*
V2>> Threshold	40 V 40 V
tV2>>	0.02 s

*If the stage/function is disabled all settings concerning this stage/function in the menu cells are hidden.

Positive Sequence Undervoltage Protection

Menu Text	Default Setting
V1 < ?	Disabled*
V1< Threshold	20 V 20 V
V1< Delay Type	DT
tV1</TMS/TD	0.02 s
V1< Reset Delay Type	DT High State
V1< DMT tReset	0 s
V1 << ?	Disabled*
V1<< Threshold	40 V 40 V
tV1<<	0.02 s

*If the stage/function is disabled all settings concerning this stage/function in the menu cells are hidden.

External Trip (Auxiliary Timers) Protection

Menu Text	Default Setting
AUX1 ?	Disabled*
tAUX1	0s
AUX2 ?	Disabled*
tAUX2	0 s
AUX3 ?	Disabled*
tAUX3	0 s

*If the stage/function is disabled all settings concerning this stage/function in the menu cells are hidden.

Output Relay Configuration

Output settings define which signals are mapped to the P1V's outputs. Matrix configuration allows free mapping of any one function to each output.

Note:

- Model L have RL1 to RL3 + WD outputs
- Model N have RL1 to RL5 + WD outputs
- Model A have RL1 to RL7 + WD outputs

Menu Text	Default Setting
Description of bits:	RL:7654321
Latched Outputs	0000000
Reverse outp.log.	0000000
Protection Trip	0000000
Prot.Trip pulse	0000000
Trip CB Order (A)	0000000
Close CB Order (A)	0000000
Alarm	0000000
Start V>	0000000
Start V>>	0000000
Start V>>>	0000000
Start V<	0000000
Start V<<	0000000
Start V<<<	0000000
Start V1< (A)	0000000
Start V1<< (A)	0000000
Start V2> (N, A)	0000000
Start V2>> (N, A)	0000000
Start VN>	0000000
Start VN>>	0000000
Start VN>>>	0000000
Start f1 (A)	0000000
Start f2 (A)	0000000
Start f3 (A)	0000000
Start f4 (A)	0000000
Start f5 (A)	0000000
Start f6 (A)	0000000
AUX1 (NA)	0000000
AUX2 (NA)	0000000
AUX3 (A)	0000000
AUX4 (A)	0000000
AUX5 (A)	0000000

Menu Text	Default Setting
tV>	0000000
tV>>	0000000
tV>>>	0000000
tV<	0000000
tV<<	0000000
tV<<<	0000000
tV1< (A)	0000000
tV1<< (A)	0000000
tV2> (N, A)	0000000
tV2>> (N, A)	0000000
tVN>	0000000
tVN>>	0000000
tVN>>>	0000000
tf1 (A)	0000000
tf2 (A)	0000000
tf3 (A)	0000000
tf4 (A)	0000000
tf5 (A)	0000000
tf6 (A)	0000000
tAUX1 (N, A)	0000000
tAUX2 (N, A)	0000000
tAUX3 (A)	0000000
CB Alarm (A)	0000000
tCB FLT Ext.Sign (A)	0000000
Setting Group 1 (N, A)	0000000
tVTS (A)	0000000
fout (A)	0000000

Input Configuration

Binary Input settings define which signals are mapped to the P1V's opto-isolated inputs. Matrix configuration allows free mapping of any one function to each input.
 Note:

- Model L have no inputs
- Model N have 2 binary inputs (L1 to L2)
- Model A have 6 binary inputs (L1 to L6)

Menu Text	Default Setting
Description of bits:	L: 654321
Reverse Input Logic	000000
Mainten. Mode (A)	000000
Reset Latched Sign	000000
Reset Latched Outputs	000000
Blocking tV> (N, A)	000000
Blocking tV>> (N, A)	000000
Blocking tV>>> (N, A)	000000
Blocking tV< (N, A)	000000
Blocking tV<< (N, A)	000000
Blocking tV<<< (N, A)	000000
Blocking tV1< (A)	000000
Blocking tV1<< (A)	000000
Blocking tV2> (N, A)	000000
Blocking tV2>> (N, A)	000000
Blocking tVN> (N, A)	000000
Blocking tVN>> (N, A)	000000
Blocking tVN>>> (N, A)	000000
Blocking f1 (A)	000000
Blocking f2 (A)	000000
Blocking f3 (A)	000000
Blocking f4 (A)	000000
Blocking f5 (A)	000000
Blocking f6 (A)	000000
AUX1 (NA)	000000
AUX2 (NA)	000000
AUX3 (A)	000000
AUX4 (A)	000000
AUX5 (A)	000000
CB Status 52A (A)	000000

Menu Text	Default Setting
CB Status 52B (A)	000000
CB FLT Ext.Sign (A)	000000
Setting group 2 (N, A)	000000
Manual Close (A)	000000
Manual Trip (A)	000000
VTS (A)	000000
Start Distur. R. (A)	000000
Local CTRL Mode (A)	000000
Time Synchr. (A)	000000

LED Configuration

LED configuration settings define which signals are mapped to the P1V's LEDs. Matrix configuration allows free mapping of any one function to each LED.

Menu Text	Default Setting
Description of bits:	LED: 765432
Latched LEDs	000000
Alarm	000000
Start V>	000000
Start V>>	000000
Start V>>>	000000
Start V<	000000
Start V<<	000000
Start V<<<	000000
Start V1< (A)	000000
Start V1<< (A)	000000
Start V2> (N, A)	000000
Start V2>> (N, A)	000000
Start VN>	000000
Start VN>>	000000
Start VN>>>	000000
Start f1 (A)	000000
Start f2 (A)	000000
Start f3 (A)	000000
Start f4 (A)	000000
Start f5 (A)	000000
Start f6 (A)	000000
AUX1 (N, A)	000000
AUX2 (N, A)	000000
AUX3 (A)	000000
AUX4 (A)	000000
AUX5 (A)	000000
tV>	000000
tV>>	000000
tV>>>	000000
tV<	000000
tV<<	000000
tV<<<	000000
tV1< (A)	000000

Menu Text	Default Setting
tV1<< (A)	000000
tV2> (N, A)	000000
tV2>> (N, A)	000000
tVN>	000000
tVN>>	000000
tVN>>>	000000
tf1 (A)	000000
tf2 (A)	000000
tf3 (A)	000000
tf4 (A)	000000
tf5 (A)	000000
tf6 (A)	000000
tAUX1 (N, A)	000000
tAUX2 (N, A)	000000
tAUX3 (A)	000000
Local CTRL Mode (A)	000000
CB Alarm (A)	000000
tCB FLT Ext.Sign (A)	000000
Setting Group 1 (N, A)	000000
tVTS (A)	000000
fout (A)	000000

GLOBAL SETTINGS

LOC

Menu Text	Default Setting
Language	English
Default Display	Measurements P – P [V]
LEDs Reset	Manual only
Latched Outputs Reset	Manual only
Trip Info Reset	Manual only
Alarm Info Latching	Self Reset
Nominal Frequency	50Hz
Control Keys Confirm	No

Setting Group Select

Menu Text	Default Setting
Setting Group	Group 1
t Change Settings G1→G2	0.00 s
Copy Settings	No Operation

VT Supervision

Menu Text	Default Setting
VT's Supervision	Disabled
Detection Mode	VTS Input
Delta V_r	15 V
tVTS	5.00 s
Inhibit VTS / 52a	No
Block [27] U/V	No
Block [59] O/V	No
Block [59N] E/GND O/V	No
Block [27D] POS. SEQ. U/V	No
Block [47] NEG. SEQ. O/V	No
Block [81] freq.	No

VT Ratio

Menu Text	Default Setting
Line VT Primary	0.1 kV 0.22 kV
Line VT Sec	100 V
Line VT Sec	220 V
E/Gnd VT Primary	0.1 kV
E/Gnd VT Sec	100 V
VT Connection (N, A)	3Upn+UN
Prot. Config. V>	P-P
Prot. Config. V<	P-P

Circuit Breaker

Menu Text	Default Setting
tOpen Pulse min	0.1 s
tClose Pulse	0.1 s
Time Delay for Close	0 s
tCB FLT ext (A)	16 s
Remote Mode (A)	0: Remote only
CB Supervision (N, A)	No
Max CB Open Time (A)	0.1 s
Max CB Close Time (A)	0.5 s

[81] Advanced Settings

Menu Text	Default Setting
Prot. Freq. Blocking	65 V
Meas. Valid. Nb of halfcycles	4

Communication

Menu Text	Default Setting
Protocol	Modbus
Relay Address	1
Baud Rate	19200 bits/s
Parity	No parity
Stop bits	1 stop bit

Disturbance Recorder

Menu Text	Default Setting
Pre-Time	0.1 s
Post-Time	0.1 s
Disturbance Rec.Trig.	on Inst.
Max Record Time	4 s

Commissioning

Menu Text	Default Setting
Description of bits:	L: 654321
Input Status (N, A)	000000
Description of bits:	RL: 7654321
Output Status	0000000
Maintenance Mode (A)	No
Description of bits:	RL: 7654321
Test Pattern (A)	0000000

Menu Text	Default Setting
Contact Test Time (A)	0.1 s
Test outputs (A)	no operation
Functional Test (A)	V>
Functional Test End (A)	Time
Functional Test Time (A)	0.1 s
Functional Test (A)	no operat.

SETTING CHANGE MODE

Menu Text	Default Setting
Edit Settings?	Enter PSWD
Setting Change	Protected
Change Password	

OP PARAMETERS

This column contains menu cells to show some of the P1V's parameters (column to read only).

Menu Text	Default Setting
Description	Easergy P1V1x
Main Location:	Substation
Sublocation:	Bay
Device name:	Name
Serial Nb	PP-YYYY-MM-DD-nnnn
Order Code	P1V1A11N1N2N1NN11N
Firmware Version	2.A
Firmware release	03
Active Set Group	Group 1
Date	01/01/15
Time	00:00:00
Nominal frequency:	50Hz or 60Hz

Technical Characteristics

General Characteristics

Characteristics	Values
Dimensions	(W x H x D): 116,5 x 116,5 x 108 mm
Weight	Approx. 0.65 kg
Maximal internal clock drift	+/-12 min a year

Auxiliary Power Supply

The Easergy P1V relays should be powered by DC or AC voltage:

Characteristics	DC Values	AC Values
Rated Voltage (N, A)	24 – 60 V +10 %/-20 %	24 – 60 V +10 %/-20 %
	90 – 250 V +10 %/-20 %	90 – 240 V +10 %/-20 %
Rated Voltage (L)	24 – 250 V +10 %/-20 %	24 – 240 V +10 %/-20 %
Ripple content	15 %	-
Frequency	-	40-70Hz
Typical consumption	24 V – 2.5 W	24 V – 4.0 VA
	240 V – 2.5 W	240 V – 10.5 VA
Maximal consumption	24 V – 4.0 W	24 V – 7.5 VA
	240 V – 4.0 W	240 V – 15 VA
Acceptable momentary outages*	24 V – 20 ms	24 V – 20 ms
	240 V – 750 ms	240 V – 1.4 s

*Half of the binary inputs and half of the output relays should be energized. Communication modules should be activated. (EN 60255-26).

Characteristics	Values																																
Auxiliary Power Supply Voltage Interruption EN 60255-26:2013	Interruption of the ac/dc auxiliary supply without de-energizing (T_{OFF}). <table border="1"> <thead> <tr> <th rowspan="2">V_x</th> <th colspan="2">*T_{OFF}</th> </tr> <tr> <th>ac</th> <th>dc</th> </tr> </thead> <tbody> <tr> <td>24 V</td> <td>20 ms</td> <td>20 ms</td> </tr> <tr> <td>48 V</td> <td>50 ms</td> <td>30 ms</td> </tr> <tr> <td>60 V</td> <td>90 ms</td> <td>50 ms</td> </tr> <tr> <td>90 V</td> <td>200 ms</td> <td>100 ms</td> </tr> <tr> <td>110 V</td> <td>300 ms</td> <td>150 ms</td> </tr> <tr> <td>220 V</td> <td>1,2 s</td> <td>600 ms</td> </tr> <tr> <td>230 V</td> <td>1,3 s</td> <td>700 ms</td> </tr> <tr> <td>240 V</td> <td>1,4 s</td> <td>750 ms</td> </tr> <tr> <td>250 V</td> <td>1,5 s</td> <td>800 ms</td> </tr> </tbody> </table>	V _x	* T_{OFF}		ac	dc	24 V	20 ms	20 ms	48 V	50 ms	30 ms	60 V	90 ms	50 ms	90 V	200 ms	100 ms	110 V	300 ms	150 ms	220 V	1,2 s	600 ms	230 V	1,3 s	700 ms	240 V	1,4 s	750 ms	250 V	1,5 s	800 ms
V _x	* T_{OFF}																																
	ac	dc																															
24 V	20 ms	20 ms																															
48 V	50 ms	30 ms																															
60 V	90 ms	50 ms																															
90 V	200 ms	100 ms																															
110 V	300 ms	150 ms																															
220 V	1,2 s	600 ms																															
230 V	1,3 s	700 ms																															
240 V	1,4 s	750 ms																															
250 V	1,5 s	800 ms																															
	*4 energized output relays																																

Line/Phase Voltage VT Analog Inputs

Characteristics	Values
Nominal voltage (V _n)	(57 ÷ 130) V _{ph-phac} eff or (220 ÷ 480) V _{ph-phac} (dependent on CORTEC number)
Operating range	(5 ÷ 200) V _{ph-phac} eff or (20 ÷ 720) V _{ph-phac}
Nominal Burden at V _n	< 0.22 VA at (57 ÷ 130) Vac; < 0.3 VA at (220 ÷ 480) Vac;
Thermal withstand	10 s @ 300/1300 V _{ph-phac} continuous: 200/720 V _{ph-phac}

Earth Voltage VT Analog Input

Characteristics	Values
Nominal voltage (V _n)	(57 ÷ 130) Vac
Operating range	(0.5 ÷ 135) Vac
Nominal Burden at V _n	< 0.43 VA
Thermal withstand	10 s @ 200 Vac continuous: 135 Vac

Frequency (Voltage Inputs)

Characteristics	Values
Nominal frequency	50 or 60 Hz (selectable in P1V menu)
Operating range	(40 ÷ 60) Hz or (50 ÷ 70) Hz

Binary Inputs

Binary inputs type: optically isolated inputs

Characteristics	Applicable to hardware option	DC Values	AC Values
Operating Range	24 – 60 Vac/dc	19 – 66 V	19 – 66 V
	90 – 240 Vac/250 Vdc	72 – 275 V	72 – 264 V
Typical switching threshold	24 – 60 Vac/dc	13 V	12 V
	90 – 240 Vac/250 Vdc	42 V	40 V
Input limit voltage at state 1	24 – 60 Vac/dc	19 V	19 V
Input limit voltage at state 0	24 – 60 Vac/dc	10 V	10 V
Input limit voltage at state 1	90 – 240 Vac/250 Vdc	72 V	72 V
Input limit voltage at state 0	90 – 240 Vac/250 Vdc	30 V	30 V
Maximum polarization current approx.	24 – 60 Vac/dc	12 mA (66 V)	12 mA (66 V)
	90 – 240 Vac/250 Vdc	2.5 mA (275 V)	2.5 mA (264 V)
Maximum continuous withstand	24 – 60 Vac/dc	66 V	66 V
	90 – 240 Vac/250 Vdc	300V	264V
Filtering Time ¹⁾	24 – 60 Vac/dc	40 ms	40 ms
	90 – 240 Vac/250 Vdc	40 ms	40 ms

Note:

¹⁾Filtering time is declared for Nominal Voltage range. For voltage value below this range additional filtering time delay: < 20ms must be considered.

Binary input energy consumption		
Logic input burden for V _x	24 – 60Vac/dc	R input = approx. 6kΩ
	90 – 240Vac/250Vdc	R input = approx. 109kΩ
Logic input recognition time	24 – 60Vac/dc	As filtering time + 2 ms
	90 – 240Vac/250Vdc	As filtering time + 2 ms

Control and Trip Relays

Below data applies following relay outputs: WD, RL1, RL2, RL3.

Characteristics	DC Values	AC Values
Contact relay	Dry contact, Ag Ni	Dry contact, Ag Ni
Rated voltage	250 V	250 V
Continuous current	5 A	5 A
Braking capacity	250 Vdc; 50 W resistive 30 W inductive (L/R = 40 ms)	1250 VA resistive (cos ϕ = unity) 1250 VA inductive (cos ϕ = 0.7)
Making capacity	250 V, 30 A, 200 ms 2000 operations	250 V, 30 A, 200 ms 2000 operations
Loaded contact	10000 operations minimum	10000 operations minimum
Unloaded contact	100000 operations minimum	100000 operations minimum
Operate time	Less than 10ms	
Reset time	Less than 5ms	

Signal Relays

Below data applies following relay outputs: RL4, RL5, RL6, RL7.

Characteristics	DC Values	AC Values
Contact relay	Dry contact, Ag Ni	Dry contact, Ag Ni
Rated voltage	250 V	250 V
Continuous current	5 A	5 A
Braking capacity	250 Vdc; 30 W resistive 15 W inductive (L/R = 40 ms)	1000 VA resistive (cos ϕ = unity) 1000 VA inductive (cos ϕ = 0.7)
Loaded contact	10000 operations minimum	10000 operations minimum
Unloaded contact	100000 operations minimum	100000 operations minimum
Operate time	Less than 10ms	
Reset time	Less than 5ms	

Communication Port

Characteristics	Values
Type	2-wire RS485 differential
Line impedance	120 Ω *

*Lack of internal terminating resistor

Environmental Characteristics

Electromagnetic Compatibility

Electromagnetic Compatibility		Standard	Level/Class	Value
Emission	Radiated emission	EN 60255-26 CISPR 11 CISPR 22	Class A	Frequency range: (30-1000 MHz) 30-230 MHz: 40 dB (μV/m) – measurement with detector QP 230-1000 MHz: 47 dB (μV/m) – measurement with detector QP Frequency range: (1 GHz-2 GHz) 56 dB (μV/m) – measurement with detector average 76 dB (μV/m) – measurement with detector peak at 3 m
	Conducted emission	EN 60255-26 CISPR 22	Class A	Frequency range: (0,15 – 30 MHz) 0,15 MHz-0,5 MHz: 79 dB (μV) – measurement with detector QP 66 dB (μV) – measurement with detector AVG 0,5 MHz-30 MHz: 73 dB (μV) – measurement with detector QP 60 dB (μV) – measurement with detector AVG
Immunity tests	Radiated digital radio telephones	EN 61000-4-3	Level 3	10 V/m, 900 MHz 100% AM, 200 Hz/50% square wave
	Radiated electromagnetic energy	EN 61000-4-3	Level 3	Test field strength, frequency band: - 80 MHz to 1000 MHz: 10 V/m, - 1.4 GHz to 2.7 GHz: 10 V/m Test using AM: 1 kHz / 80% sinus Spot frequencies: 80 MHz, 160 MHz, 380 MHz, 450 MHz, 900 MHz, 1850 MHz, 2150M Hz 80% AM, 1 kHz, 100% (duty cycle)
	Electrostatic discharge	EN 61000-4-2	Level 3	8 kV discharge in air to all communication ports. 6 kV point contact discharge to any part of the front of the product.
	1 MHz Burst High Frequency Disturbance Test	EN 61000-4-18	Level 3	Common-mode test voltage: 2.5 kV, Differential test voltage: 1.0 kV, 1 Mhz, 75 ns, 400 Hz, 200 Ω Test duration: 2 s
	Magnetic fields at power frequencies	EN 61000-4-8	Level 5	50 Hz, 100 A/m – 1 minute for each position

				50 Hz, 1000 A/m – 1 seconds for each position
Pulse magnetic fields immunity test	EN 61000-4-9	Level 5		6,4/16 μ s magnetic pulse 1000 A/m Applied to enclosure
Conducted radiofrequency disturbances	EN 61000-4-6	Level 3		Disturbing test voltage: 10 V, 150 kHz to 80 MHz, 80% Amplitude Modulation, 1 kHz Spot frequencies: 27 MHz, 68 MHz
Electrical fast transients/burst	EN 61000-4-4	Level 3		Amplitude: 2 kV, Burst frequency 5 kHz (5/50 ns)
Surges	EN 61000-4-5	Level 3		Time to half-value: 1.2/50 μ s, Amplitude: 2 kV between all groups and case earth, Amplitude: 1 kV between terminals of each group
ac and dc voltage dips	EN 61000-4-11 EN 61000-4-29	–		0% of residual voltage: 10 ms, 20 ms, 50 ms, 100 ms, 200 ms, 500 ms (ac/dc) 40% of residual voltage: 200 ms (50 Hz), 200 ms(60 Hz) 200 ms (dc) 70% of residual voltage: 500 ms (50 Hz), 500 ms(60 Hz) 500 ms (dc)
ac and dc voltage interruptions	EN 61000-4-11 EN 61000-4-29	–		0% residual voltage, 5 s (50 Hz), 5s (60 Hz) 5 s (dc)
ac component in dc (ripple)	EN 61000-4-17	–		15% of rated dc value 100 Hz and 120 Hz
Gradual shut-down/start –up (for dc power supply)	EN 60255-26	–		Shut-down ramp 60 s power off 5 min start-up ramp 60 s

Mechanical Robustness

Mechanical Robustness	Standard	Level/Class	Value
Vibration	EN 60255-21-1	Class 1	Response 0,5 g_n ; 10 Hz – 150Hz Endurance 1 g_n ; 10 Hz – 150Hz
Shock and bump	EN 60255-21-2	Class 1	Shock response 5 g_n /11 ms Shock withstand 15 g_n /11 ms Bump 10 g_n /16 ms
Seismic	EN 60255-21-3	Class 2	2 g_n horizontal / 1 g_n vertical

Climatic Requirements

Climatic Requirements	Standard	Level/Class	Value
Ambient temperature range	EN 60255-1 EN 60068-2-1 EN 60068-2-2	Ad, Bd Ae, Be Ab, Bb	Operating temperature range: -25 °C to +60 °C (-13 °F to +140 °F), Short time operation temperature range (<16h) -30 °C to +70 °C (-22 °F to +158 °F). Storage and transit: -30 °C to +70 °C (-22 °F to +158 °F).
Ambient humidity range	EN 60068-2-78	Cab	21 days at 93% relative humidity and +40 °C 10 days at 93% relative humidity and +60 °C
Cyclic temperature with humidity test	EN 60068-2-30	Db	Damp heat cyclic, six (12 + 12) hour cycles, 93% RH, +25 °C to +55 °C
Corrosive Environments	EN 60068-2-60	Ke (Method 4)	Industrial corrosive environments/poor environmental control, mixed gas flow test. 21 days at 75% relative humidity and 25 °C Exposure to elevated concentrations of H ₂ S(10 ppb), Cl ₂ (10 ppb), NO ₂ (200 ppb), SO ₂ (200 ppb)
Cyclic temperature test	EN 60068-2-14	Nb	-25 °C to +60 °C 100 cycles

Safety Requirements

Safety requirements	Standard	Value
Insulation	EN 60255-27	Insulation resistance > 500 MΩ at 500 Vdc (Using electronic/brushless insulation tester).
Creepage distances and clearances	EN 60255-27	Pollution degree 2, Overvoltage category III, Impulse test voltage 5 kV,
High Voltage (dielectric) withstand	EN 60255-27	2 kV rms AC, 1 min: between all case terminals connected together, and the case earth/ground; 2 kV RMS AC, 1 minute: between all terminals of independent circuits. 1 kV rms AC for 1 min: across normally open control and signaling contacts
Impulse voltage withstand	EN 60255-27	Front time: 1.2 μs, Time to half-value: 50 μs, Peak value: 5 kV Source Characteristics: 500 Ohm, 0.5 J.

Enclosure Protection

Enclosure protection	Standard	Value
Enclosure protection	EN 60529	IP 20 Protection for relay housing IP 20 Protection for terminals. IP 54 Protection (front panel) for flush mounted case

Certification/declaration

CE European Commission's directives	EN 60255-26	EMC Directive 2014/30/EU
	EN 60255-27	LV Directive 2014/35/EU

Maintenance

Preventive Maintenance

Introduction

To obtain maximum availability of the installation, it is essential to keep Easergy P1V operational full time. The P1V internal self-tests (external memory (FRAM, FLASH), analog inputs waveform, RTC check, hardware watchdog), and the watchdog relay alert the user in the event of internal Easergy P1V failure.

Nonetheless, elements outside the P1V are not subject to these self-tests and it is therefore necessary to carry out regular preventive maintenance.

Nothing inside the Easergy P1V requires preventive maintenance, nor can anything be replaced by the user.

List of Interventions

The table below gives the typical frequency of interventions. The intervals between visual inspections depends on the installation operating conditions.

Intervention	Frequency
Routine check	Weekly
LED test Inspection of the rear panel	Annual
Checking the complete trip chain	Every 5 years

Routine Check

- Make sure that the phase and neutral voltages measured by Easergy P1V are appropriate for the load being powered.
- Check that the Healthy LED is on and not blinking.

LED Test

The LED test is used to check that each LED on the front panel are working correctly.

To perform the test (if any protections are not triggered), press R button from default display menu level. After this, all LEDs on the front panel light up for approx. 1 s.

Inspection of the Rear Panel

Check that the connections are tight and free from corrosion, and the VT connections.

Checking the Trip Chain

It is important to check regularly that the complete trip chain, from the VTs to the P1V and through to the trip coil, is always operational.

Troubleshooting Assistance

Introduction

The paragraphs below list the actions to be taking after observing abnormal Easergy P1V behavior. In the event of an anomaly, do not cut off the auxiliary power supply before making a diagnosis.

LEDs and Display Unit Off

Symptom	Possible Causes	Action/Remedy	Refer to...
All the LEDs are off, as well as the display unit	Auxiliary power supply is not connected	Connect auxiliary power supply to terminals A1 - A2	Identification of the Connectors on the Rear Panel, page 21
	Auxiliary power supply absent	Check that the auxiliary power supply level is within the permissible range.	Power Supply Voltage, page 237
	Internal failure	Change the P1V unit.	Removing P1V, page 19

Easergy P1V Healthy LED flashing

Flashing of the Healthy LED indicates that Easergy P1V has gone into the fail position following detection by the embedded self-tests of the failure of one of its components.

The fail position is characterized by:

- Healthy LED flashing
- Watchdog relay, in the off-position
- Output relays in the off-position (normal position)
- Communication inoperative

In this case, Easergy P1V is no longer operational. Change the P1V.

No Display or Incomplete Display

Symptom	Possible Causes	Action/Remedy	Refer to...
The Healthy LED is on (lights up green), but the display does not appear or is incomplete	Failure of the display unit	Change the P1V unit	Removing P1V, page 19

Communication Problem (N, A)

During normal operation, the status of the rear communication port is signaled by flashing rectangles in the top and bottom right corners of the display. Tx (Transmit) is assigned to the top right corner, Rx (Receive) is assigned to the bottom right

corner of the display. Flashing of the rectangles indicate the operation of the rear communication port.

If the Easergy P1V relay is not communicating with the SCADA system, check:

- That the supervisor is sending frames to the relevant P1V
- All the P1V communication parameters
- The wiring of each P1V
- The tightness of the screw terminals on connector A of each P1V
- The bus polarization, at a single point, in general by the master
- The line matching at the ends of the RS 485 network

If the problem persists, connect the P1V relays one by one on the communication network to determine which P1V relay is responsible for the problem.

Lost Password

If you lost the password, read the serial number on the Easergy P1V label and contact your local Schneider Electric after-sales service.

Removing Easergy P1V

Introduction

If the Easergy P1V relay cannot be repaired by following the instructions in *Troubleshooting Assistance*, page 245, it must be replaced.

Removing Easergy P1V

⚠ DANGER

HAZARD OF ELECTRIC SHOCK, ELECTRIC ARC, BURNS OR EXPLOSION

- Wear insulating gloves to avoid any contact with a conductor that has accidentally been energized.

Failure to follow these instructions will result in death or serious injury.

The procedure for removing the Easergy P1V relay is as follows:

Step	Action
1	If the P1V allows you to, read (or extract by eSetup Easergy Pro event and disturbance recorder) and make a note of the last trips/events that have occurred.
2	Make a note of the symptoms observed, in particular the failure codes displayed.
3	Switch off the unit.
4	Unscrew all wires
5	Depending on assembly method unscrew fastening elements or disassemble spring clips
6	Remove the Easergy P1V.

Return for Expert Assessment

If returning the Easergy P1V for expert assessment, use the original packaging or packaging offering level 1 protection against vibrations (standard IEC 60255-21-1) and against shocks (standard IEC 60255-21-2).

The Easergy P1V relay must be returned accompanied by its settings sheet and the following information:

- Name and address of the initiator
- Easergy P1V type and serial number
- Date of the incident
- Description of the incident
- LED status and message displayed at the time of the incident
- List of stored events

End of Life

If the Easergy P1V is not repairable:

Step	Action
1	Remove the Easergy P1V as indicated above.
2	Dismantle the Easergy P1V in accordance with the End-of-Life Instructions for Easergy P1. These instructions provide: <ul style="list-style-type: none">• Recyclability rates for our products.• Guidance for mitigating personnel hazards during the dismantling of your products and before recycling operations.• Parts identification for recycling or for selective treatment, to mitigate environmental hazards/incompatibility with standard recycling processes.

Application Cases

3VTs and VN application

Description

Model (N, A) Easergy P1V relays can be use in following applications.

Details:

- 3x phase (phase to neutral) voltages are measured in A, B and C phase
- Neutral voltage is measured from open delta
- Trip Signal is assigned to relay output 1

Figure 45. 3VTs and VN application diagram

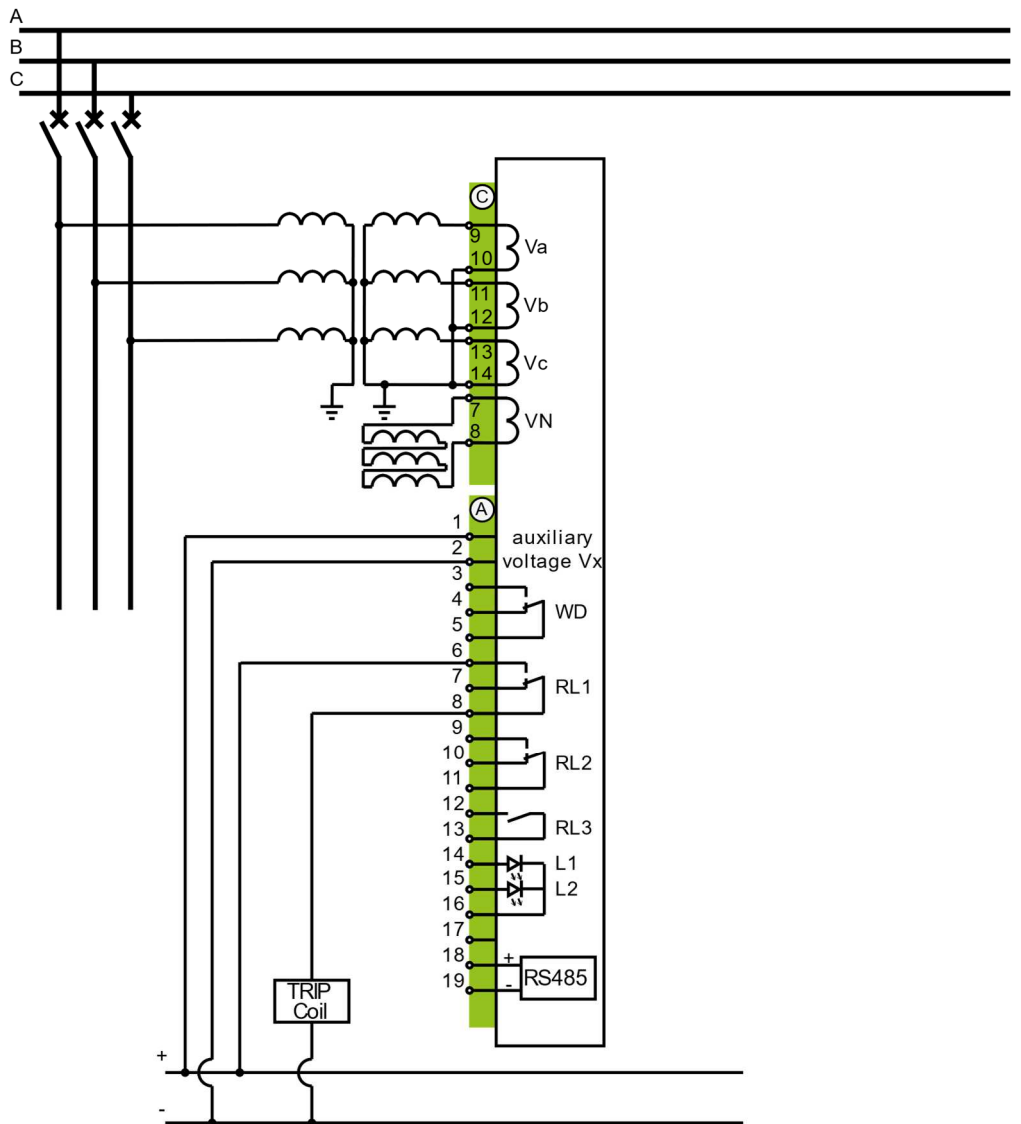

Note: Above application can be realized on model L Easergy P1V but in this case neutral voltage will be derived from vector sum $(\vec{V}_a + \vec{V}_b + \vec{V}_c)$.

3VTs and VN with CB Control

Description

Models **N**, **A** of Easergy P1V relays can be use in following applications.

Details:

- Phase to phase voltages are measured between phases A and B, B and C; C and A
- Neutral voltage is measured from open delta
- Trip and Trip CB Order signals are assigned to relay output 1
- Close CB Order signal is assigned to relay output 2
- CB status is assigned to binary inputs 1 (close) and 2 (open)
- Communication port RS 485 is connected to SCADA system (CB control is possible from SCADA also – depending on selected control mode)

Figure 46. 3VTs and VN application diagram

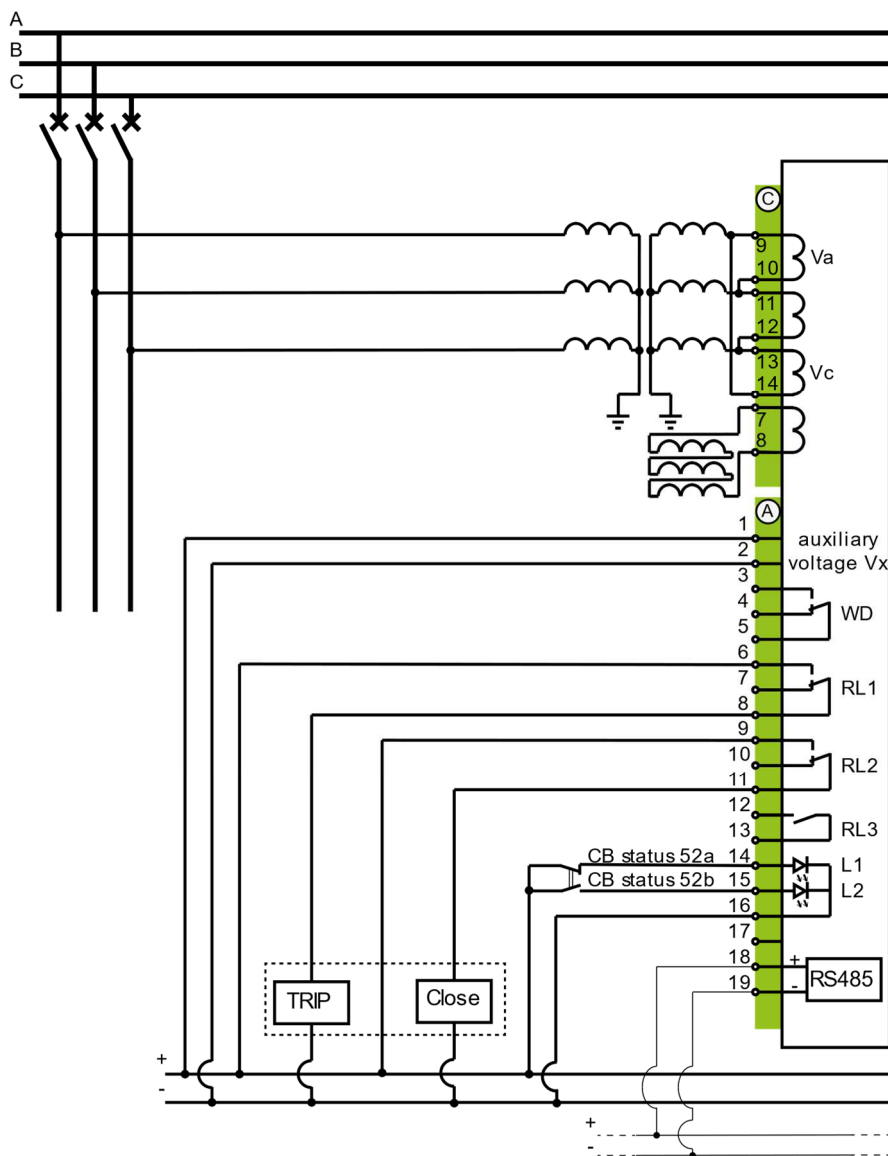

Logic Discrimination

Description

This type of protection (**N, A**) can be applied to radial feeder circuits where there is little or no back feed. For parallel feeders, ring circuits or where there can be a back feed from generators, directional relays should be considered.

The blocking logic function allows the upstream IDMT relay to be blocked by the start output of a downstream relay that has detected the presence of a fault current or voltage above its threshold. Thus, both upstream and downstream relays can have the same voltage and time settings, and the blocking feature will automatically provide grading. If the CB failure protection is active, the blocking command on the upstream relay will be removed if the down-stream circuit breaker fails to trip.

Thus, for a fault downstream from relay C, the start output from relay C will aim to prevent relay B from operating and the start output of relay B will aim to prevent relay A from operating. Therefore all 3 relays could have the same timer and voltage settings and grading would be obtained by the blocking signal received from a relay closer to the fault. This gives a constant, close time grading, but there will be no back-up protection in the event of pilot wires being short-circuited.

In practice it is recommended to set the upstream relay to a value that is 10% higher than the downstream relay setting. This helps to ensure that the downstream relay successfully blocks the upstream relay when required.

Figure 47. Logic discrimination application diagram

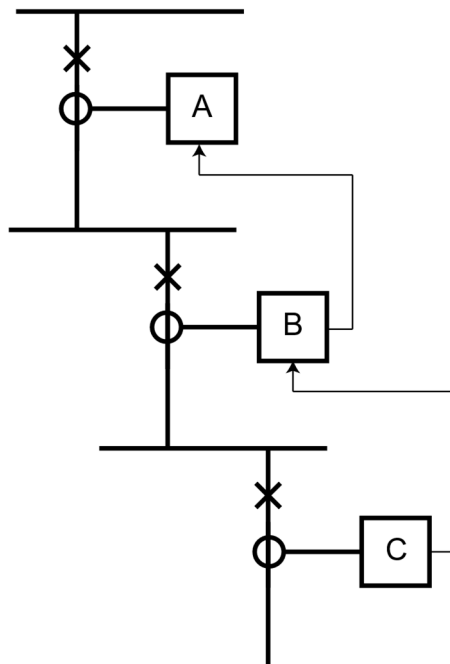

- The "Blocking Logic" functions are assigned in the **SETTING GROUP x/ INPUT CONFIGURATION Gx/** menu. Every protection element can be assigned a blocking function: Block.tV>, (**N, A**), Block.tV>>, (**N, A**), Block.tV>>>, (**N, A**), Block.tV<, (**N, A**), Block.tV<<, (**N, A**), Block.tV<<<, (**N, A**), Block.tV1<, (**A**), Block.tV1<<, (**A**), Block.tV2>, (**N, A**), Block.tV2>>, (**N, A**), Block.tVN>, (**N, A**), Block.tVN>>, (**N, A**), Block.tVN>>>, (**N, A**), Block.tf1, (**A**), Block.tf2, (**A**), Block.tf3, (**A**), Block.tf4, (**A**), Block.tf5, (**A**), Block.tf6, (**A**).

Easergy P1V relays have separate blocking functions, which can be used to block every protection element.



Customer Care Center

<http://www.se.com/cc>

Schneider Electric

35 rue Joseph Monier

92506 Rueil-Malmaison FRANCE

Phone: +33 (0) 1 41 29 70 00

Fax: +33 (0) 1 41 29 71 00

www.se.com