

Shower tray without Anti-Slip

854954 000 000 1

Shower tray with Anti-Slip

854954 600 000 1



TECHNICAL DATA / WITHOUT ANTI-SLIP

Order no.	854954 000 000 1
Dimensions	1200 x 700 mm
Depth	65 mm
Specification	rectangle ceramic shower trays without Anti-Slip
Weight	33,0 kg
Mounting acc. excl.	use commercial outlet drain Ø 90 mm
Colours	see colour table

TECHNICAL DATA / WITH ANTI-SLIP

Order no.	854954 600 000 1
Standard	DIN 51097, Group B (till 24°)
Dimensions	1200 x 700 mm
Depth	65 mm
Specification	rectangle ceramic shower trays with Anti-Slip
Weight	33,0 kg
Mounting acc. excl.	use commercial outlet drain Ø 90 mm
Colours	see colour table

TECHNICAL DRAWINGS / S 1 : 20

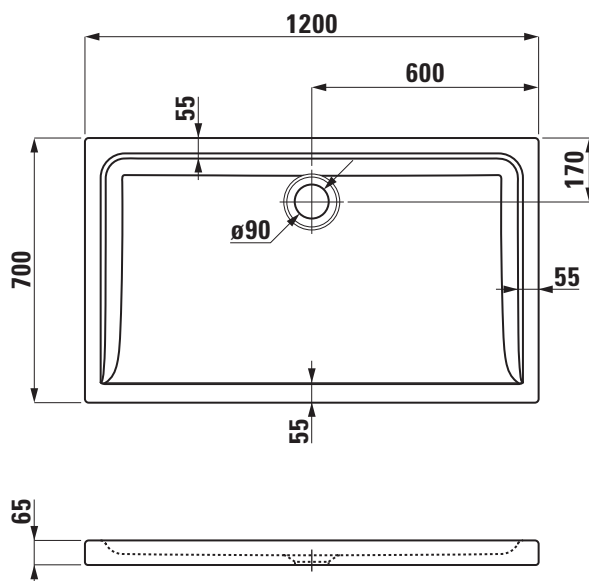

TECHNICAL DRAWINGS / S 1 : 20

