



TANGENT™ RAIL SEATING

PRODUCT DATA





TANGENT™ RAIL SEATING

PRODUCT DATA

Tangent Rail Seating offers a clean design aesthetic, the durability of die-cast aluminum, and the versatility that comes with a wide range of seat, rail and leg options. Built to last in high-traffic public settings, Tangent is ideal for corporate campuses, healthcare facilities, colleges and universities, transportation hubs and more.

MATERIAL & CONSTRUCTION DETAILS

MATERIAL & CONSTRUCTION DETAILS		INSTALLATION & MAINTENANCE
CONFIGURATIONS <ul style="list-style-type: none"> • Straight configurations of Tangent Rail Seating are available with one, two, three, four, or five seats. • Custom articulating configurations of Tangent Rail Seating are available, see examples shown on page 5; please contact us for details. • All configurations are available with backed or backless seats. 	FRAME <ul style="list-style-type: none"> • Seat frames and connection castings are made of die-cast aluminum and stainless steel; rails and legs are made of extruded aluminum. All frame components have a powdercoat finish. • See the Forms+Surfaces Powdercoat Chart for details. Custom RAL colors are available for an upcharge. • Due to the inherent nature of metal castings, gloss powdercoats are not offered for cast components. 	INSTALLATION <ul style="list-style-type: none"> • Tangent Rail Seating can be surface mounted, cast in-place or freestanding. • Surface mounted post leg models include cast aluminum mounting feet, anchors and stainless steel mounting screws. • Surface mounted "A" leg models include a stainless steel mounting foot.
SEAT OPTIONS <ul style="list-style-type: none"> • Backed and backless seats are available in three material options. • FSC® 100% Ipé hardwood slats offer superior resistance to moisture, insects, fire, vandalism and decay; natural oiled finish enhances the wood's rich color. (FSC License Code: FSC-C004453) • Extruded aluminum slats are powdercoated. • Stainless steel seat pans are available in three stainless steel finishes or can be powdercoated. Stainless steel seat pans have three standard perforation pattern options, or can be specified with no pattern, as shown below. • See the Forms+Surfaces Powdercoat Chart for details. Custom RAL colors are available for an upcharge. 	LEG OPTIONS <ul style="list-style-type: none"> • Hexagonal post legs are available as surface mount or cast-in-place. • "A" legs are available as freestanding or surface mount, and are available for straight configurations only. 	MAINTENANCE <ul style="list-style-type: none"> • Metal surfaces can be cleaned as needed using a soft cloth or brush with warm water and a mild detergent. Avoid abrasive cleaners. • Ipé hardwood slats can be maintained by re-oiling as needed with Penolin® hardwood finish or similar products.
	OPTIONAL INTERMEDIATE ARMRESTS <ul style="list-style-type: none"> • Optional intermediate armrests may be placed between seats and are made of die-cast aluminum with a powdercoat finish to match the frame components. • Straight configurations of Tangent Rail Seating use one intermediate armrest between each seat and no end armrests. • Custom articulating configurations of Tangent Rail Seating use an armrest to the right of each seat and at each end. 	

SEAT STYLES

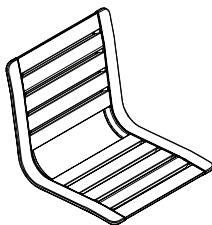

Backed Slat Seats,
Ipé or Extruded Aluminum

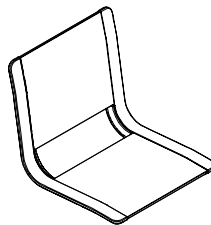

Backed Pan Seats,
Stainless Steel

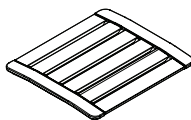

Backless Slat Seats,
Ipé or Extruded Aluminum

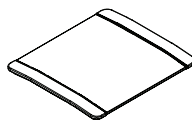

Backless Pan Seats,
Stainless Steel



TANGENT™ RAIL SEATING

PRODUCT DATA

SEAT MATERIAL OPTIONS



FSC 100% IPÉ HARDWOOD SLATS

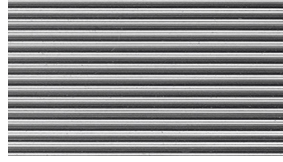

EXTRUDED ALUMINUM SLATS

STAINLESS STEEL SEAT PAN FINISH OPTIONS



SANDSTONE



DIAMOND

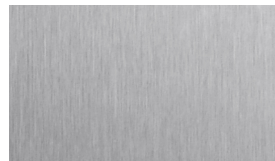

SATIN

STAINLESS STEEL SEAT PAN PATTERN OPTIONS

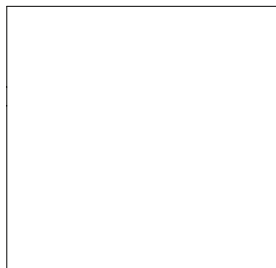

NO PATTERN

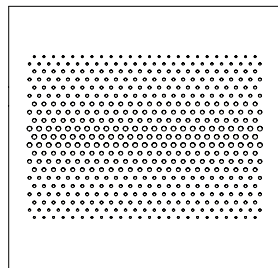

FADE

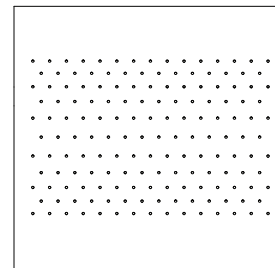

MICRO

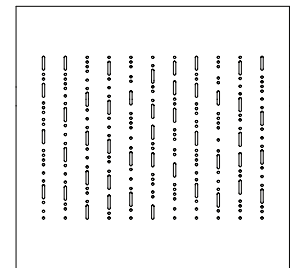

STITCH



TANGENT™ RAIL SEATING

PRODUCT DATA

STRAIGHT CONFIGURATIONS: BACKLESS SEAT, POST LEG

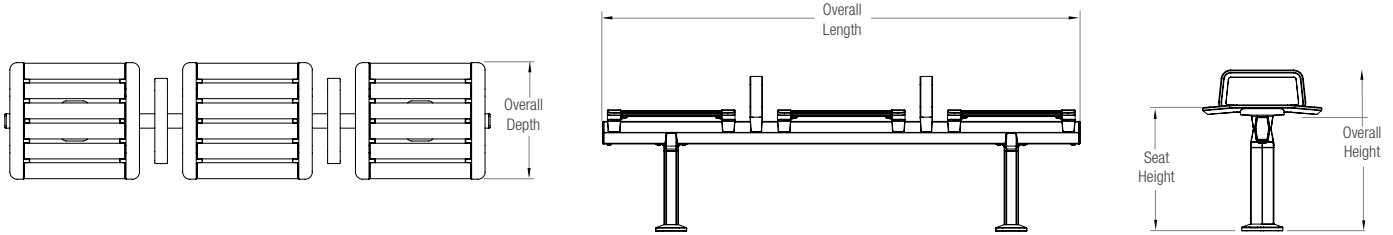

MODEL	OVERALL LENGTH	OVERALL DEPTH	SEAT HEIGHT	OVERALL HEIGHT*	WEIGHT**		
					ALUMINUM SLATS	IPÉ SLATS	SEAT PANS
SRTAN-1LA, -1LW, -1LS	19.4" (492 mm)	16.2" (411 mm)	17.1" (434 mm)	21.8" (554 mm)	27 lbs (12 kg)	26 lbs (12 kg)	28 lbs (13 kg)
SRTAN-2LA, -2LW, -2LS	43.4" (1,102 mm)	16.2" (411 mm)	17.1" (434 mm)	21.8" (554 mm)	57 lbs (26 kg)	56 lbs (26 kg)	61 lbs (28 kg)
SRTAN-3LA, -3LW, -3LS	67.4" (1,712 mm)	16.2" (411 mm)	17.1" (434 mm)	21.8" (554 mm)	81 lbs (37 kg)	80 lbs (36 kg)	86 lbs (39 kg)
SRTAN-4LA, -4LW, -4LS	91.4" (2,322 mm)	16.2" (411 mm)	17.1" (434 mm)	21.8" (554 mm)	105 lbs (48 kg)	103 lbs (47 kg)	112 lbs (51 kg)
SRTAN-5LA, -5LW, -5LS	115.4" (2,931 mm)	16.2" (411 mm)	17.1" (434 mm)	21.8" (554 mm)	136 lbs (62 kg)	134 lbs (61 kg)	145 lbs (66 kg)

*Dimensions shown are for surface mounted models with optional armrests. 11 inches are added to the leg length for cast-in-place models for the portion to be embedded underground.

**4.2 lbs is included per intermediate armrest.

STRAIGHT CONFIGURATIONS: BACKED SEAT, POST LEG

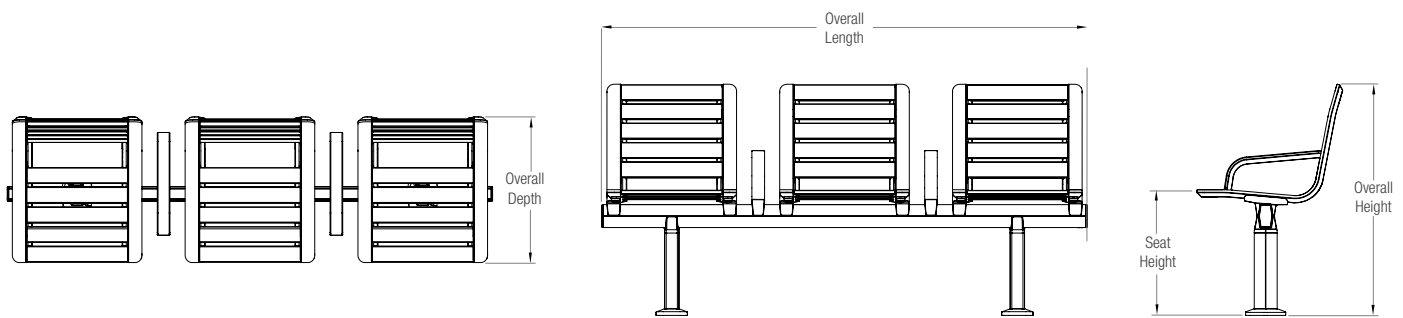

MODEL	OVERALL LENGTH	OVERALL DEPTH	SEAT HEIGHT	OVERALL HEIGHT*	WEIGHT**		
					ALUMINUM SLATS	IPÉ SLATS	SEAT PANS
SRTAN-1BA, -1BW, -1BS	19.4" (492 mm)	20.2" (513 mm)	17.5" (445 mm)	32.1" (815 mm)	36 lbs (16 kg)	35 lbs (16 kg)	42 lbs (19 kg)
SRTAN-2BA, -2BW, -2BS	43.4" (1,102 mm)	20.2" (513 mm)	17.5" (445 mm)	32.1" (815 mm)	78 lbs (35 kg)	75 lbs (34 kg)	88 lbs (40 kg)
SRTAN-3BA, -3BW, -3BS	67.4" (1,712 mm)	20.2" (513 mm)	17.5" (445 mm)	32.1" (815 mm)	111 lbs (50 kg)	108 lbs (49 kg)	128 lbs (58 kg)
SRTAN-4BA, -4BW, -4BS	91.4" (2,322 mm)	20.2" (513 mm)	17.5" (445 mm)	32.1" (815 mm)	141 lbs (64 kg)	138 lbs (63 kg)	167 lbs (76 kg)
SRTAN-5BA, -5BW, -5BS	115.4" (2,931 mm)	20.2" (513 mm)	17.5" (445 mm)	32.1" (815 mm)	159 lbs (72 kg)	155 lbs (70 kg)	186 lbs (84 kg)

*Dimensions shown are for surface mounted models. 11 inches are added to the leg length for cast-in-place models for the portion to be embedded underground.

**4.9 lbs is included per intermediate armrest.



TANGENT™ RAIL SEATING

PRODUCT DATA

STRAIGHT CONFIGURATIONS: BACKLESS SEAT, "A" LEG

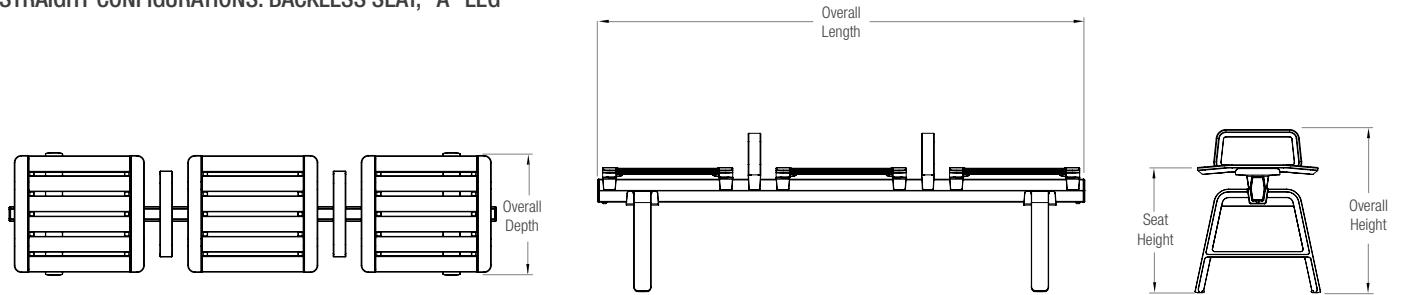

MODEL	OVERALL LENGTH	OVERALL DEPTH	SEAT HEIGHT	OVERALL HEIGHT*	WEIGHT**		
					ALUMINUM SLATS	IPÉ SLATS	SEAT PANS
SRTAN-2LA, -2LW, -2LS	43.4" (1,102 mm)	16.2" (411 mm)	17.2" (437 mm)	21.9" (556 mm)	62 lbs (28 kg)	61 lbs (28 kg)	66 lbs (30 kg)
SRTAN-3LA, -3LW, -3LS	67.4" (1,712 mm)	16.2" (411 mm)	17.2" (437 mm)	21.9" (556 mm)	86 lbs (39 kg)	84 lbs (38 kg)	91 lbs (41 kg)
SRTAN-4LA, -4LW, -4LS	91.4" (2,322 mm)	16.2" (411 mm)	17.2" (437 mm)	21.9" (556 mm)	110 lbs (50 kg)	108 lbs (49 kg)	117 lbs (53 kg)
SRTAN-5LA, -5LW, -5LS	115.4" (2,931 mm)	16.2" (411 mm)	17.2" (437 mm)	21.9" (556 mm)	144 lbs (65 kg)	141 lbs (64 kg)	152 lbs (69 kg)

*Dimensions shown include optional armrests.

**4.2 lbs is included per intermediate armrest.

STRAIGHT CONFIGURATIONS: BACKED SEAT, "A" LEG

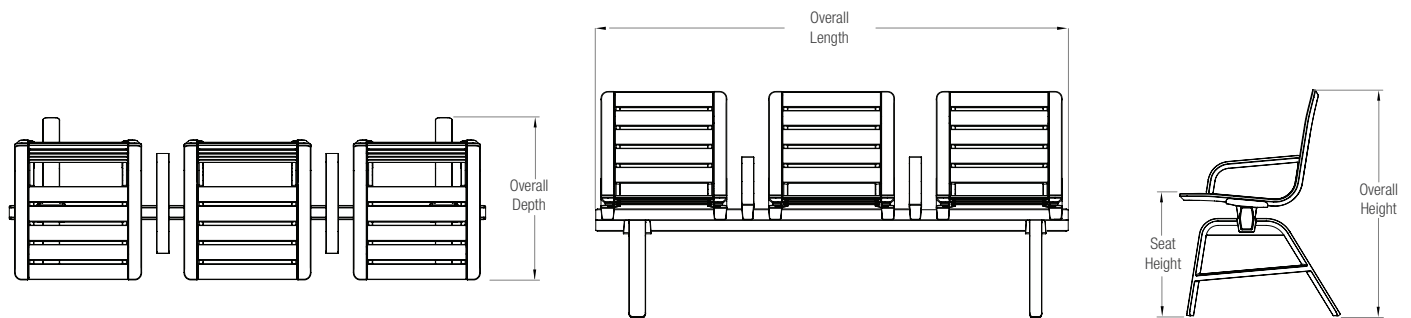

MODEL	OVERALL LENGTH	OVERALL DEPTH	SEAT HEIGHT	OVERALL HEIGHT	WEIGHT**		
					ALUMINUM SLATS	IPÉ SLATS	SEAT PANS
SRTAN-2BA, -2BW, -2BS	43.4" (1,102 mm)	20.2" (513 mm)	17.5" (445 mm)	32.1" (815 mm)	84 lbs (38 kg)	83 lbs (38 kg)	96 lbs (43 kg)
SRTAN-3BA, -3BW, -3BS	67.4" (1,712 mm)	20.2" (513 mm)	17.5" (445 mm)	32.1" (815 mm)	118 lbs (54 kg)	115 lbs (52 kg)	135 lbs (61 kg)
SRTAN-4BA, -4BW, -4BS	91.4" (2,322 mm)	20.2" (513 mm)	17.5" (445 mm)	32.1" (815 mm)	152 lbs (69 kg)	148 lbs (67 kg)	175 lbs (79 kg)
SRTAN-5BA, -5BW, -5BS	115.4" (2,931 mm)	20.2" (513 mm)	17.5" (445 mm)	32.1" (815 mm)	197 lbs (90 kg)	193 lbs (88 kg)	226 lbs (103 kg)

**4.9 lbs is included per intermediate armrest.



TANGENT™ RAIL SEATING

PRODUCT DATA

EXAMPLE ARTICULATING RAIL CONFIGURATIONS

The rail can be articulated to a maximum inward angle of 20° and a maximum outward angle of 45°. Please contact us for details on your specific project. The examples shown are just a starting point; all custom articulating configurations are available with backed or backless seats and any seat material option.

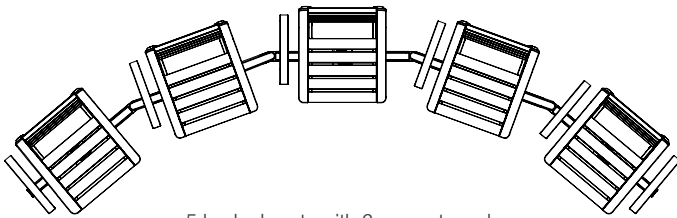

5 backed seats with 6 armrests and 4 points of articulation.

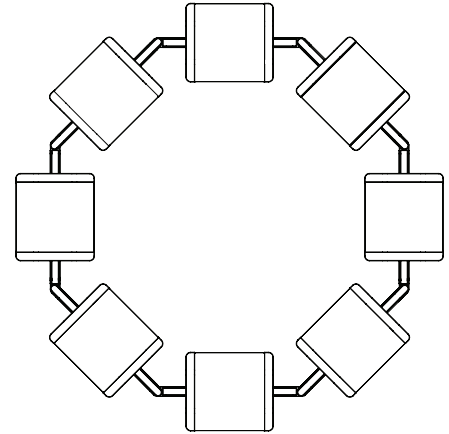

8 backless seats with 8 points of articulation.

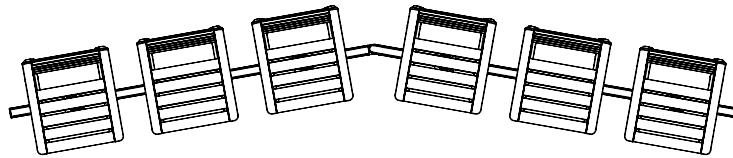

6 backed seats with 1 point of articulation.

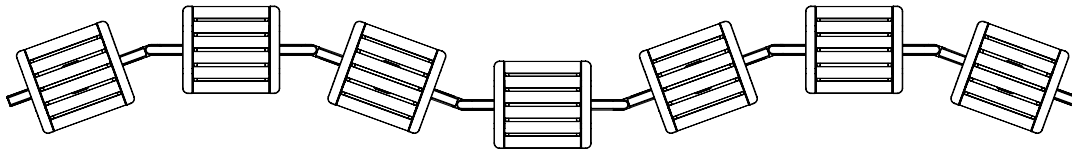

7 backless seats with 6 points of articulation.



TANGENT™ RAIL SEATING

PRODUCT DATA

ENVIRONMENTAL CONSIDERATIONS

- Please refer to the Tangent Rail Seating Environmental Data Sheet for detailed environmental impact information.
- Tangent Rail Seating aluminum frames have a high recycled content.
- All Tangent Rail Seating metal components are fully recyclable.
- All Tangent Rail Seating wood is FSC® 100%.
- Standard powdercoat finishes are no-VOC; non-standard powdercoat finishes are no- or low-VOC, depending on color.
- Low maintenance; easy to disassemble.

MODEL NUMBERS AND DESCRIPTIONS

MODEL	DESCRIPTION
SRTAN-1BA	Tangent Rail Seating, Straight, 1 backed seat, aluminum slats
SRTAN-1BW	Tangent Rail Seating, Straight, 1 backed seat, Ipé slats
SRTAN-1BS	Tangent Rail Seating, Straight, 1 backed seat, stainless steel seat pan
SRTAN-2BA	Tangent Rail Seating, Straight, 2 backed seats, aluminum slats
SRTAN-2BW	Tangent Rail Seating, Straight, 2 backed seats, Ipé slats
SRTAN-2BS	Tangent Rail Seating, Straight, 2 backed seats, stainless steel seat pans
SRTAN-3BA	Tangent Rail Seating, Straight, 3 backed seats, aluminum slats
SRTAN-3BW	Tangent Rail Seating, Straight, 3 backed seats, Ipé slats
SRTAN-3BS	Tangent Rail Seating, Straight, 3 backed seats, stainless steel seat pans
SRTAN-4BA	Tangent Rail Seating, Straight, 4 backed seats, aluminum slats
SRTAN-4BW	Tangent Rail Seating, Straight, 4 backed seats, Ipé slats
SRTAN-4BS	Tangent Rail Seating, Straight, 4 backed seats, stainless steel seat pans
SRTAN-5BA	Tangent Rail Seating, Straight, 5 backed seats, aluminum slats
SRTAN-5BW	Tangent Rail Seating, Straight, 5 backed seats, Ipé slats
SRTAN-5BS	Tangent Rail Seating, Straight, 5 backed seats, stainless steel seat pans
SRTAN-1LA	Tangent Rail Seating, Straight, 1 backless seat, aluminum slats
SRTAN-1LW	Tangent Rail Seating, Straight, 1 backless seat, Ipé slats
SRTAN-1LS	Tangent Rail Seating, Straight, 1 backless seat, stainless steel seat pans
SRTAN-2LA	Tangent Rail Seating, Straight, 2 backless seats, aluminum slats
SRTAN-2LW	Tangent Rail Seating, Straight, 2 backless seats, Ipé slats
SRTAN-2LS	Tangent Rail Seating, Straight, 2 backless seats, stainless steel seat pans
SRTAN-3LA	Tangent Rail Seating, Straight, 3 backless seats, aluminum slats
SRTAN-3LW	Tangent Rail Seating, Straight, 3 backless seats, Ipé slats
SRTAN-3LS	Tangent Rail Seating, Straight, 3 backless seats, stainless steel seat pans
SRTAN-4LA	Tangent Rail Seating, Straight, 4 backless seats, aluminum slats
SRTAN-4LW	Tangent Rail Seating, Straight, 4 backless seats, Ipé slats
SRTAN-4LS	Tangent Rail Seating, Straight, 4 backless seats, stainless steel seat pans
SRTAN-5LA	Tangent Rail Seating, Straight, 5 backless seats, aluminum slats
SRTAN-5LW	Tangent Rail Seating, Straight, 5 backless seats, Ipé slats
SRTAN-5LS	Tangent Rail Seating, Straight, 5 backless seats, stainless steel seat pans



TANGENT™ RAIL SEATING

PRODUCT DATA

PRODUCT OPTIONS

The following options are available for an upcharge

Perforation pattern for stainless steel seat pans	Upgrade from surface mount or cast-in-place to freestanding
Upgrade from powdercoat finish to stainless steel finish for stainless steel seat pans	Premium Texture Colors from Forms+Surfaces Powdercoat Chart
Intermediate armrest(s)	Custom RAL powdercoat color

LEAD TIME: 6 to 8 weeks. Shorter lead times may be available upon request. Please contact us to discuss your specific timing requirements.

PRICING: Please contact us at **800.451.0410** or **sales@forms-surfaces.com**. At Forms+Surfaces, we design, manufacture and sell our products directly to you. Our sales team is available to assist you with questions about our products, requests for quotes, and orders. Territory Managers are located worldwide to assist with the front-end specification and quoting process, and our in-house Project Sales Coordinators follow your project through from the time you place an order to shipment.

TO ORDER SPECIFY: Quantity, model, powdercoat color(s), seat material, leg and mounting options. Quote/Order Forms are available on our website to lead you through the specification process in a simple checkbox format.

NOTE: Because different computers, monitors and printers render colors differently, actual colors will vary slightly from those shown here.