

# MY SPACE acoustic furniture

By NARBUTAS design team



## ORDERING GUIDELINES

MY SPACE is a modular system which offers you possibility to create your own space in the office. From a single to a vast number of combined workspaces.

This guide is designed to help understand basics of ordering MY SPACE as well as to highlight exceptions which should be taken into account when creating you workspace. In this guide you will find most common combinations and explanations regarding which parts should be ordered for the combination you have designed.

## BASICS OF ORDERING MY SPACE

Steps below provide general process flow of creating your own combination and ordering correct parts. Please note that this is simply one of several ways you can go through creating MY SPACE combination.

### STEP 1: Choosing your workspace

There are several things that have to be taken into account before selecting screens and fittings. First of all decision about size and shape of the combination, system (screen) height, and desktop type should be made. Having selected workspace which you need will help with choosing correct screens and fittings.

#### SIZE AND SHAPE

Determine the shape and size of the desired combination. This is rather straightforward – select number of work spaces and a shape of your combination. In this example 4 person work space connected in H type shape will be provided.



#### NOTE:

- It is not possible to combine different height screens in a single combination.
- It is not possible to mix rectangular and trapezoid desktops in a single combination.

#### DESKTOP TYPE

Combination shape defines the shape of desktop. In this case rectangular desktop are needed to achieve such combination. In this step you have to choose width, depth and type of desktop: with grommer or a cut-out.

## BASICS OF ORDERING MY SPACE

### STEP 2: Choosing correct screens

After workspaces are selected, corresponding screens can be selected. In this guide „front“ screen and „side“ screen will be used to provide a more informative description of the system. However, MY SPACE offers universal screens and there is no difference between screens: both „front“ and „side“ screen are the same screen. That differs are the screen types (without desktop brackets, with desktop brackets on one side, with desktop brackets on both sides), heights and widths.

#### „FRONT“ SCREEN

In this guide „front“ screen is referred to as a screen which a person is facing while sitting next to the desktop. In every case, „front“ screen width is dictated by the desktop width. Choose same width „front“ screen as the desktop width.

Screen type should be selected based on your combination layout. If workspace is only on one side of the screen - screen with desktop brackets on one side should be selected. In case there are workspaces on both sides of the screen - screen with desktop brackets on both sides should be selected.

In this example we have workspaces on both sides of the screen, therefore screens (1) with desktop brackets on both sides are required.



#### NOTE:

- In case of trapezoid desktop all screens have to be 1024 mm wide. This applies to both „side“ screens and „front“ screen. No other width is available for such type of desktop.
- It is not possible to combine different height screens in a single combination.

## BASICS OF ORDERING MY SPACE

### „SIDE“ SCREEN

In this guide „side“ screen is referred to as a screen which is located on both sides of the desktop.

Screen type should be selected based on our combination layout. If workspace is only on one side of the screen, screen with brackets on one side should be selected. In case there workspaces on both sides of the screens, screen with brackets on both sides should be selected.

In this example we have screens (1) on the ends of the combination. Such screens have workspaces on one side, therefore screens with brackets on one side are required. Central screens (2) have workspaces on both sides therefore screens with brackets on both sides are required.

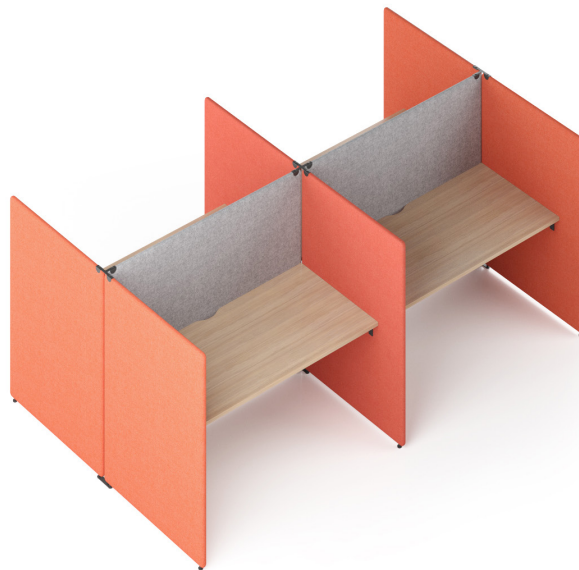

#### NOTE:

- In case of rectangular desktop „side“ screens can only be 824 wide. No other width is available for such type of desktop.
- In case of trapezoid desktop all screens have to be 1024 mm wide. This applies to both „side“ screens and „front“ screen. No other width is available for such type of desktop.
- It is not possible to combine different height screens in a single combination.

### STEP 3: Legs and top joints

After combination size and shape, and screen types were selected, selecting legs and top joints is straightforward. Fittings follow the shape of the screens – screens placed perpendicular will need „L“ type fitting to connect, while four screens meeting at 90° will need „X“ type to connect.





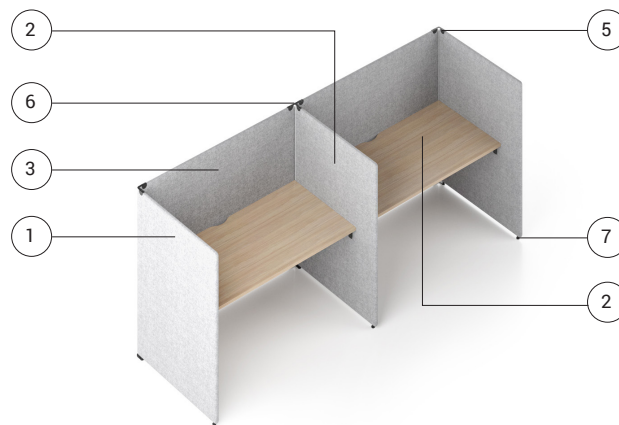

#### NOTE:

- Screens which side is not connected to other screens should end with a „O“ type leg.

## ORDERING EXAMPLE 1



## Pricelist item's selection

		Description	Code	Quantity
1		Screen with desktop fittings for one side	ASU081	2 pc.
2		Screen with desktop fittings for two sides and Ø 80 mm grommet	ASU082	1 pc.
3		Screen with desktop fittings for one side	ASU101	2 pc.
4		Desktop with a cut-out (scallop) for wire management and metal frame	ASD100	2 pc.
5		Metal leg "L" (90°) and top joint	ASZ008	2 pc.
6		Metal leg "T" (90°) and top joint	ASZ009	1 pc.
7		Metal leg "O"	ASZ007	3 pc.





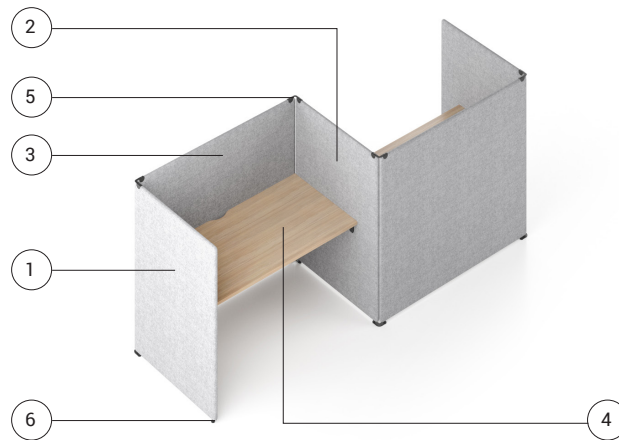

This example was for two workspaces. If you wish to extend this single combination you should add following components for each additional workspace:

- 1 x desktop;
- 1 x screen with desktop fittings for two sides and Ø 80 mm grommet (always 824 mm);
- 1 x screen with desktop fittings for one side (front screen, based on desktop width);
- 1 x metal leg "T" (90°) and top joint;
- 1 x metal leg "O".

## ORDERING EXAMPLE 2



## Pricelist item's selection

		Description	Code	Quantity
1		Screen with desktop fittings for one side	ASU081	2 pc.
2		Screen with desktop fittings for two sides and Ø 80 mm grommet	ASU082	1 pc.
3		Screen with desktop fittings for one side	ASU121	2 pc.
4		Desktop with a cut-out for grommet and metal frame	ASD120	2 pc.
5		Metal leg "L" (90°) and top joint	ASZ008	4 pc.
6		Metal leg "O"	ASZ007	2 pc.

This example was for two workspaces. If you wish to extend this single combination you should add following components for each additional workspace:





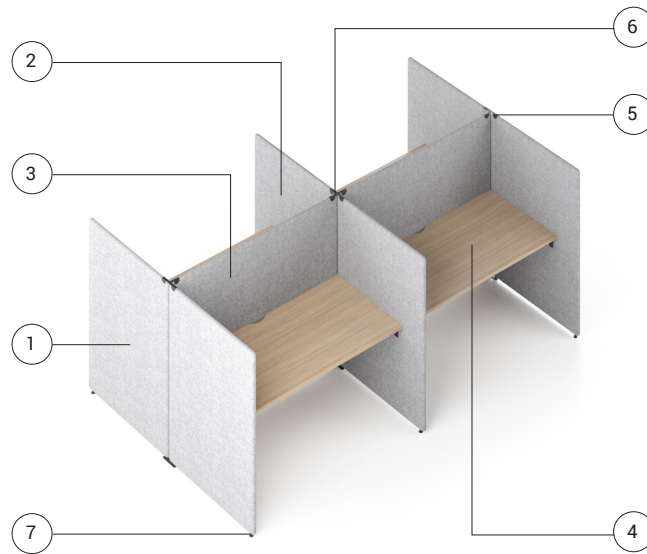

- 1 x screen with desktop fittings for two sides and Ø 80 mm grommet;
- 1 x screen with desktop fittings for one side (front screen, based on desktop width);
- 1 x desktop with a cut-out for grommet and metal frame;
- 2 x metal leg "L" (90°) and top joint.



## ORDERING EXAMPLE 3



## Pricelist item's selection

		Description	Code	Quantity
1		Screen with desktop fittings for one side	ASU081	4 pc.
2		Screen with desktop fittings for two sides and Ø 80 mm grommet	ASU082	2 pc.
3		Screen with desktop fittings for two sides and Ø 80 mm grommet	ASU122	2 pc.
4		Desktop with a cut-out for grommet and metal frame	ASD120	4 pc.
5		Metal leg "X" (90°) and top joint	ASZ010	1 pc.
6		Metal leg "T" (90°) and top joint	ASZ009	2 pc.
7		Metal leg "O"	ASZ007	6 pc.



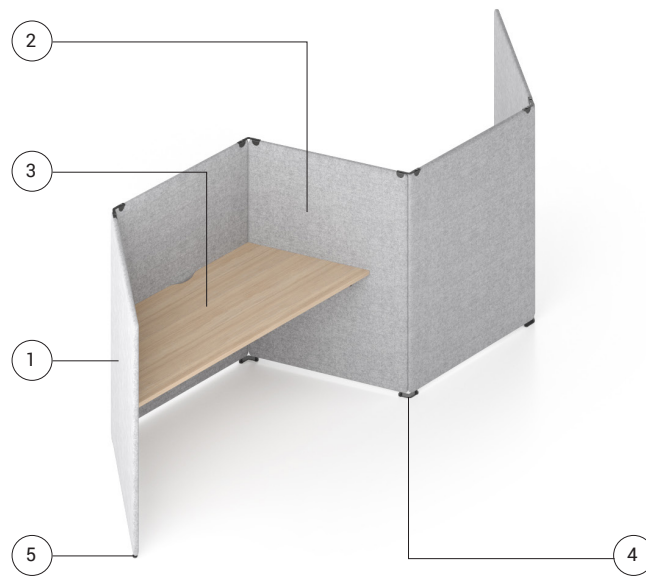

This example was for two workspaces. If you wish to extend this single combination you should add following components for each additional segment of workspace (2 parallel workspaces):

- 2 x screen with desktop fittings for two sides and Ø 80 mm grommet (824 mm) – side screens;
- 2 x screen with desktop fittings for two sides and Ø 80 mm grommet – front screens;
- 1 x Metal leg "X" (90°) and top joint;
- 2 x Metal leg "O".

## ORDERING EXAMPLE 4



## Pricelist item's selection

		Description	Code	Quantity
1		Screen with desktop fittings for one side	ASU101	4 pc.
2		Screen with desktop fittings for two sides and Ø 80 mm grommet	ASU102	1 pc.
3		Desktop with a cut-out for grommet and metal frame	ASD190	2 pc.
4		Metal leg "V" (120°) and top joint	ASZ012	4 pc.
5		Metal leg "O"	ASZ007	2 pc.

This example was for two workspaces. If you wish to extend this single combination you should add following components for each additional workspace:







- 1 x screen with desktop fittings for one side (front screen);
- 1 x screen with desktop fittings for two sides and Ø 80 mm (central side screen);
- 1 x desktop;
- 1 x metal leg "V" (120°) and top joint.



## ORDERING EXAMPLE 5



## Pricelist item's selection

	Description	Code	Quantity
1	 Screen with desktop fittings for one side	ASU101	7 pc.
2	 Screen with desktop fittings for two sides and Ø 80 mm grommet	ASU102	4 pc.
3	 Desktop with a cut-out for grommet and metal frame	ASD170	5 pc.
4	 Metal leg "V" (120°) and top joint	ASZ012	2 pc.
5	 Metal leg "Y" (120°) and top joint	ASZ013	4 pc.
6	 Metal leg "O"	ASZ007	6 pc.





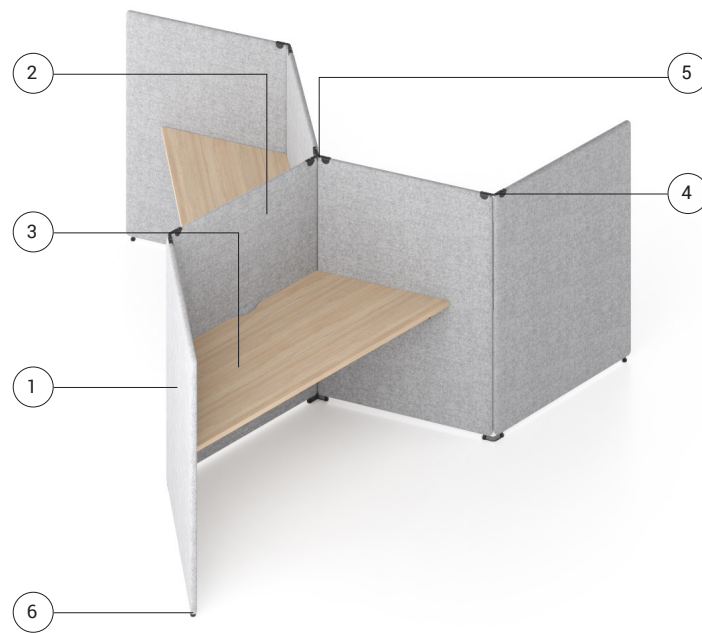

This example was for 5 workspaces. If you wish to extend this single combination you should add following components for each additional workspace:

- 1 x Screen with desktop fittings for one side;
- 1 x Screen with desktop fittings for two sides and Ø 80 mm grommet;
- 1 x Desktop with a cut-out for grommet and metal frame;
- 1 x Metal leg "Y" (120°) and top joint;
- 1 x Metal leg "O".

## ORDERING EXAMPLE 6



## Pricelist item's selection

		Description	Code	Quantity
1		Screen with desktop fittings for one side	ASU101	3 pc.
2		Screen with desktop fittings for two sides and Ø 80 mm grommet	ASU102	3 pc.
3		Desktop with a cut-out for grommet and metal frame	ASD170	3 pc.
4		Metal leg "V" (120°) and top joint	ASZ012	3 pc.
5		Metal leg "Y" (120°) and top joint	ASZ013	1 pc.
6		Metal leg "O"	ASZ007	3 pc.