

Sink Happy Hour - 1050 850

Sinks

Code: 1050 850



DETAILS

Finish Foster brushed

Material AISI 304 stainless steel

Texture Satin

Edge/Installation Type Undermount

Dimensions 1447x502 mm

Standard fittings Fixing hooks, gasket, drain, overflow and siphon, boxed packing

Mixer holes No standard holes

Built-in hole 1397x477 mm

Drainer No

Width	145 cm
Bowl dimension	1397x400 mm
Number of bowls	1 bowl
Waste fitting	Drain SPACE 3,5"

EQUIPMENT

1 x Black Grid 8100 600
1 x Bamboo chopping board
8200 002

FEATURES

Diamond-shape bottom	The draining of water is an important feature in a sink, and it's always taken good care of in Foster products. In the bent-welded sinks, which would have a flat bottom, the proper draining is guaranteed by the elegant beveling, which helps the water flow.
High thickness	1mm thick steel. A significant thickness, which guarantees the maximum sturdiness and durability.
Space waste fitting	The elegant SPACE steel cap closes the drain and leaves no visible residues collected in the basket below. Space also has a small footprint and allows the optimal use of the under-sink compartment.
Save space system	Drain and siphon are designed to leave as much space as possible in the under-sink area, more and more useful today for theseparate waste collection systems.
Triple recess - sliding accessories	The Foster Milano sink has an ingenious design that makes it simple to use a large set of optional accessories. On the topmost supporting step, the innovative Black grids slide, creating a large and practical surface to rinse food and crockery. The second step is meant to support and allow the sliding of a complete combination of accessories, which make some operations practical and safe: rinse, drain, slice, grate... everything can be done inside the sink. The third supporting step is on the bottom of the bowl. On this step one can rest the Black grids, making it possible to rinse foodstuffs without their coming in contact with the bottom of the sink, which may be dirty.

Perimetral overflow

The overflow is always a security on the Foster sinks that prevents the overflow of water in case of oversights. The perimeter drain solution improves aesthetics thanks to its square and essential shape.

TECHNICAL DATA

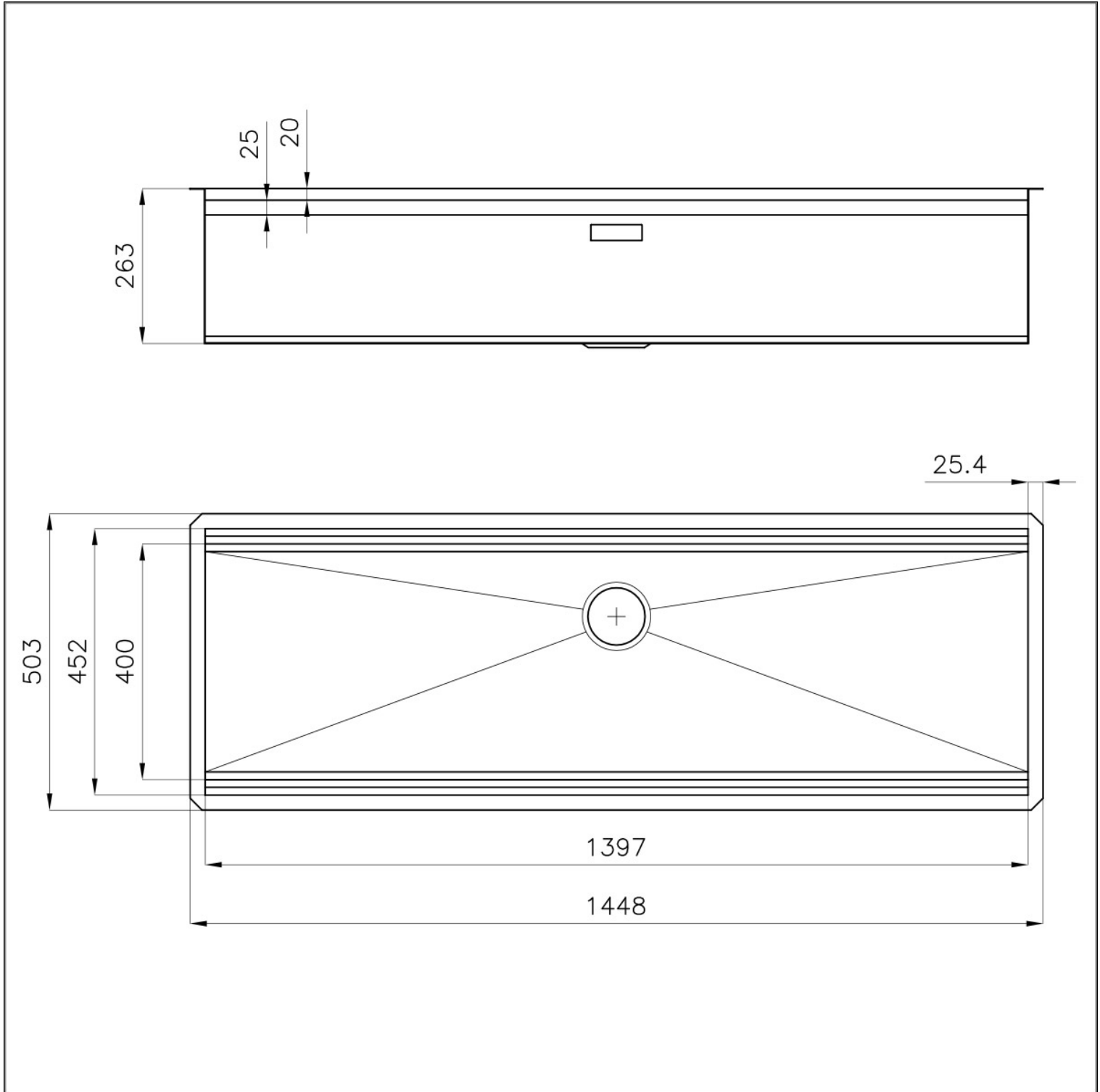

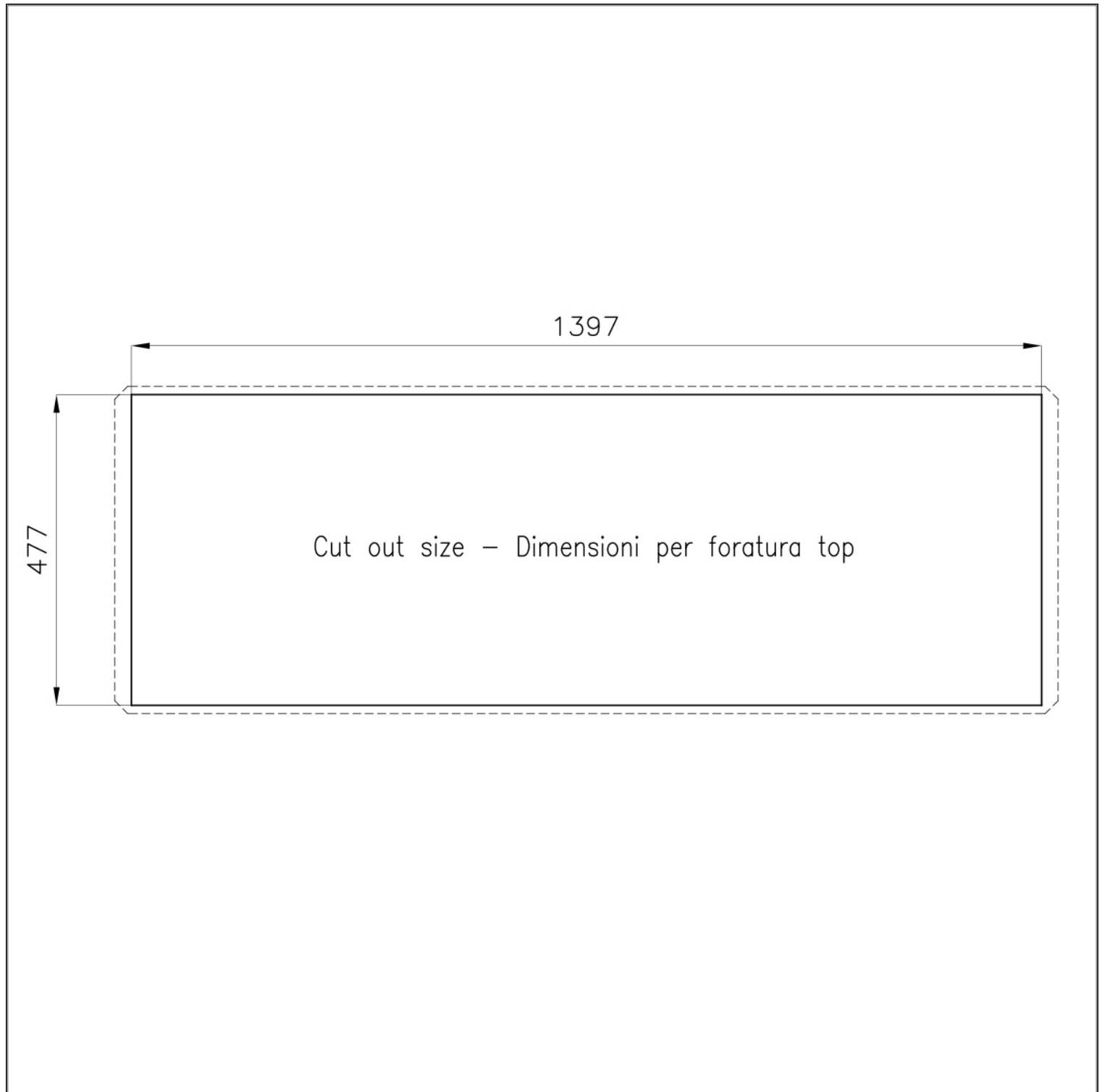

Happy Hour Optional accessories / Accessori opzionali

The "rails" system makes it possible use a combination of numerous accessories. Grids, chopping boards, utensils' ranging system, bowls and containers of different dimensions can be alternated in the workspace with a simple gesture, and can easily be stacked, in order to be on hand at all times.

Il sistema di "corsie" rende possibile l'utilizzo combinato di innumerevoli accessori. Griglie, taglieri, portautensili, vaschette e contenitori di varie dimensioni si alternano nella zona di lavoro con un semplice gesto e possono essere impilati, sempre a portata di mano.

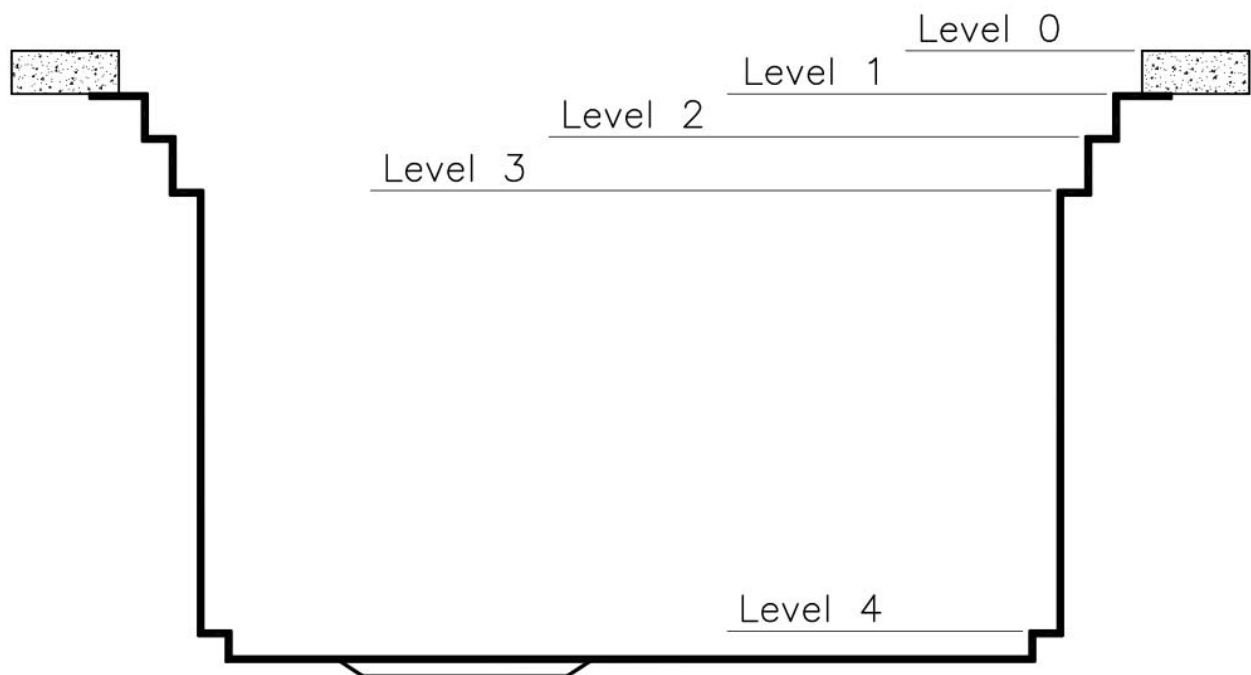

GALLERY

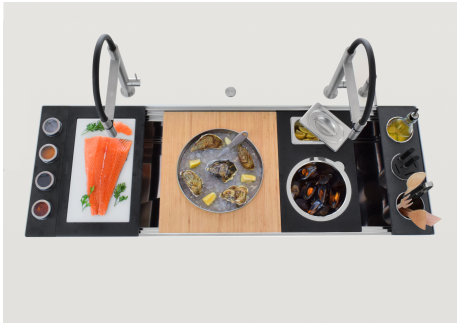
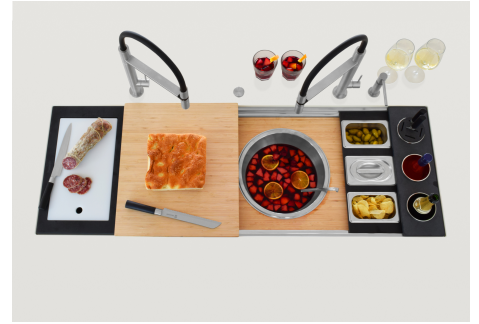

Optional accessories

The "rails" system makes it possible to use a combination of numerous accessories. Grids, chopping boards, utensils, ranging systems, bowls and containers of different dimensions can be alternated in the workspace with a simple gesture, and can easily be stacked, in order to be on hand at all times.

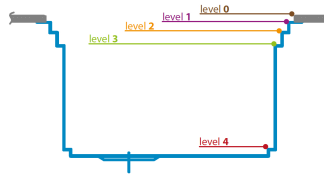

EQUIPMENT



Bamboo chopping board 8200 002



Black grid 8100 600

OPTIONAL ACCESSORIES

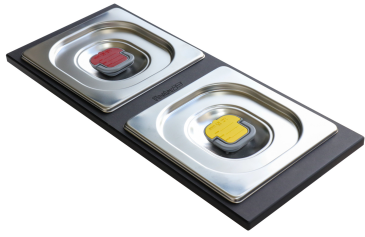

2 Bowls set 8100 623



3 Bottles-holder set 8100 621



3 Bottles-holder set 8100 626



3 Bowls set 8100 622



3 Bowls set 8100 624



4 Spices-holder set 8100 620



4 Spices-holder set 8100 625



Glass chopping board 8631 300



Graters kit with ring-holder and food collection tray 8159 101



HDPE + Black Twin chopping board 8100 627



HPDE Twin chopping board 8644 101



Kit bowl Ø30 cm with bamboo support - 8200 601



Kit multi-bowl 8100 628



Stainless steel perforated tray
8151 000

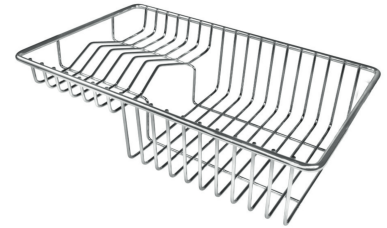

Stainless steel plate rack 8100 303



Steel tray 1778 000



Walnut-wood chopping board
8642 000



White bowl 8153 100

RECOMMENDED PAIRINGS

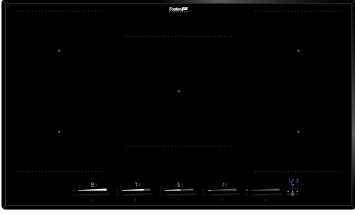

Cooker hob KE Induction 7384 645

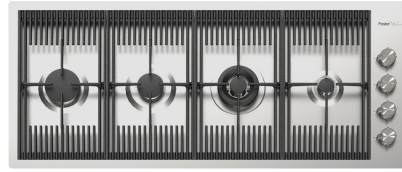

Cooker hob Milanello 7681 000



Dispenser Evo Satin 8520 100



Mixer Tap Milanello 8425 100



Space Push automatic waste fitting 8407 116