



**QUADRA™ SEATING SYSTEM**

PRODUCT DATA





# QUADRA™ SEATING SYSTEM

PRODUCT DATA

The **Quadra Seating System** is a minimalist modular family comprised of seating, tables and planters. Constructed of TENSU Ultra High Performance Concrete (UHPC), an exceptionally durable material, Quadra modules in three sizes can be used in multiple orientations and combined in numerous ways. They're also highly configurable and can incorporate different inset materials: FSC® Recycled 100% Teak slats, powdercoated aluminum, or TENSU UHPC for use as seats or tables, or planter liners. Simple in form and functionality, this adaptable group offers cohesive design flexibility—think of the line as building blocks for shaping pedestrian-friendly circulation paths, dividing space, and creating site-specific gathering areas.

## MATERIAL & CONSTRUCTION DETAILS

## INSTALLATION & MAINTENANCE

CONSTRUCTION	PLANTER OPTIONS	INSTALLATION
<ul style="list-style-type: none"> <li>Quadra modules are cast of TENSU Ultra High Performance Concrete (UHPC) and have an intrinsic UHPC finish in Natural color.</li> <li>TENSU surfaces are protected by a hydrophobic treatment.</li> <li>Base is cast aluminum with a Slate Texture powdercoat finish.</li> <li>Slight variations in color and surface texture can occur due to the nature of the TENSU manufacturing process.</li> </ul>	<ul style="list-style-type: none"> <li>Planter liners are molded polyethylene.</li> <li>All liners are available with or without drainage holes.</li> <li>17" planter capacity is 4.1 gallons/15.6 liters; 48" planter capacity is 16.3 gallons/61.7 liters.</li> <li>72" Quadra modules specified with planters have a 17" planter insert and 55" seating surface (as shown on page 5).</li> </ul>	<ul style="list-style-type: none"> <li>Quadra modules can be freestanding or surface mounted.</li> <li>Surface mount models include stainless steel mounting hardware.</li> <li>A crane or other equipment appropriate for moving a 164-416 lb. object is required.</li> </ul>
CONFIGURATIONS	SEAT INSET OPTIONS	MAINTENANCE
<ul style="list-style-type: none"> <li>Quadra modules can be configured for use as seating, tables, or planters.</li> <li>Quadra modules are available in 17" 49", and 72" lengths.</li> <li>Quadra modules can be specified with the aperture in the casting facing front to back for use as seating or tables.</li> <li>Quadra modules can also be specified with the aperture oriented top to bottom, in which case a variety of materials, or a planter liner, can be inset into the top opening to create distinctive seating, tables and planters.</li> </ul>	<ul style="list-style-type: none"> <li>Wood insets have FSC® Recycled 100% Teak hardwood slats and a natural oiled finish. (FSC License Code: FSC-C004453).</li> <li>TENSU UHPC insets are available with or without a surface pattern.</li> <li>Aluminum insets have a powdercoat finish.</li> <li>See the Forms+Surfaces Powdercoat Chart for details. Custom RAL colors are available for an upcharge.</li> <li>All Forms+Surfaces powdercoat colors have been formulated to be ultra-durable for improved long-term wear and resistance to weathering. Our powdercoat colors are also anti-graffiti, allowing marks from paint, permanent markers, and dirt to be easily removed.</li> <li>Due to the inherent nature of metal castings, gloss powdercoats are not offered for cast components.</li> </ul>	<ul style="list-style-type: none"> <li>Metal and TENSU UHPC surfaces can be cleaned as needed using a soft cloth or brush with warm water and a mild detergent. Surfaces should be thoroughly rinsed and allowed to dry. Avoid abrasive cleaners.</li> <li>FSC® Recycled 100% Teak hardwood slats can be maintained by re-oiling as needed with linseed oil. Avoid abrasive cleaners and spray polishes.</li> </ul>

## NOMINAL DIMENSIONS

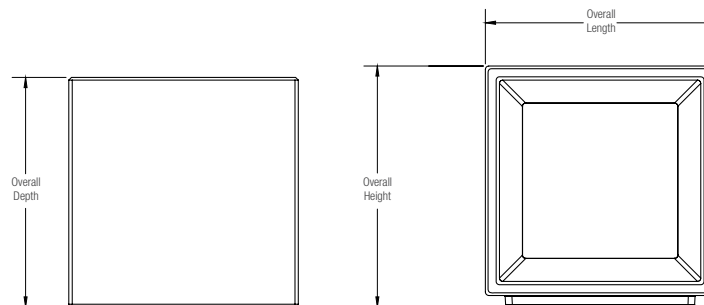

Shown with aperture front-to-back

MODEL	OVERALL LENGTH	OVERALL DEPTH	OVERALL HEIGHT	WEIGHT
SBQUA-17S	17" (432 mm)	17" (432 mm)	17.9" (455 mm)	164 lbs (74.4 kg)



**NOMINAL DIMENSIONS CONTINUED**

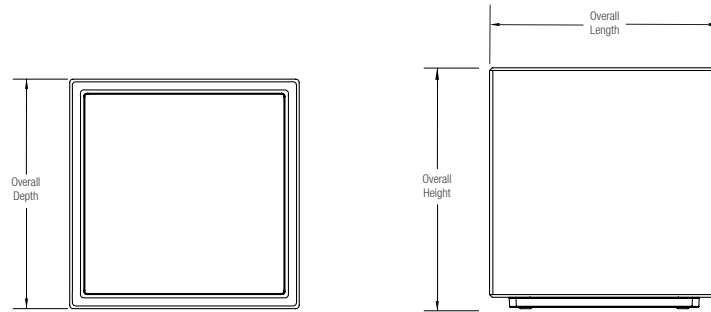

Shown with aperture top-to-bottom (aluminum inset configuration)

MODEL	OVERALL LENGTH	OVERALL DEPTH	OVERALL HEIGHT	WEIGHT
SBQUA-17A	17" (432 mm)	17" (432 mm)	17.8" (452 mm)	180 lbs (81.6 kg)
SBQUA-17T	17" (432 mm)	17" (432 mm)	17.8" (452 mm)	192 lbs (87.1 kg)
SBQUA-17W	17" (432 mm)	17" (432 mm)	17.8" (452 mm)	180 lbs (81.6 kg)
SBQUA-17P	17" (432 mm)	17" (432 mm)	17.8" (452 mm)	177 lbs (80.3 kg)

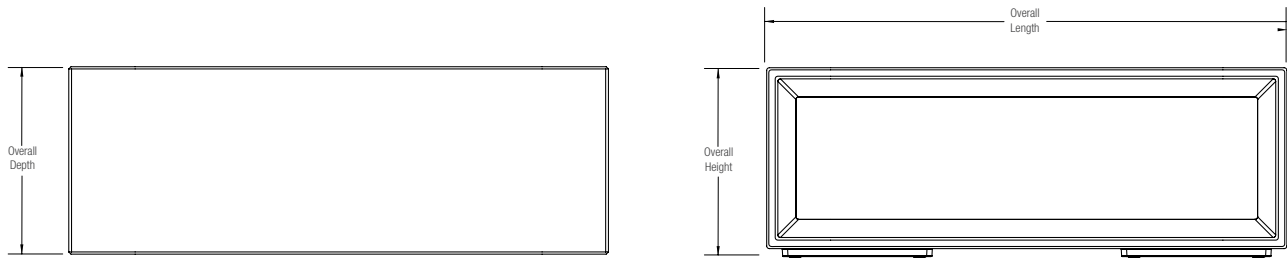

Shown with aperture front-to-back

MODEL	OVERALL LENGTH	OVERALL DEPTH	OVERALL HEIGHT	WEIGHT
SBQUA-48S	48.8" (1219 mm)	17" (432 mm)	17.9" (455 mm)	340 lbs (154.2 kg)

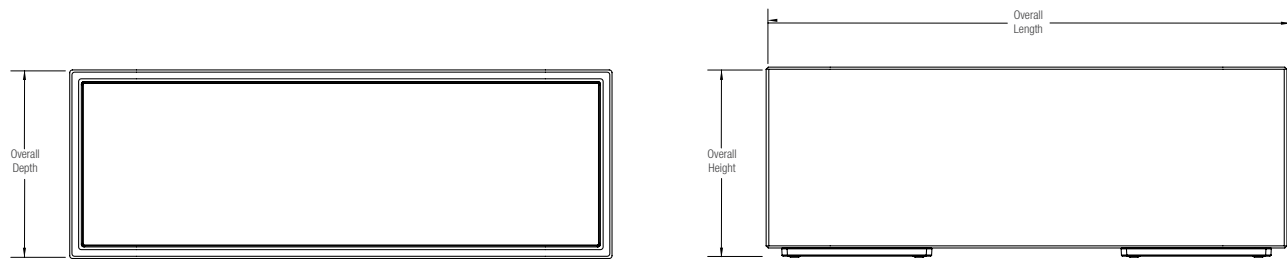

Shown with aperture top-to-bottom (aluminum inset configuration)

MODEL	OVERALL LENGTH	OVERALL DEPTH	OVERALL HEIGHT	WEIGHT
SBQUA-48A	48.8" (1219 mm)	17" (432 mm)	17.9" (455 mm)	379 lbs (171.9 kg)
SBQUA-48T	48.8" (1219 mm)	17" (432 mm)	17.9" (455 mm)	416 lbs (188.7 kg)
SBQUA-48W	48.8" (1219 mm)	17" (432 mm)	17.9" (455 mm)	379 lbs (171.9 kg)
SBQUA-48P	48.8" (1219 mm)	17" (432 mm)	17.9" (455 mm)	369 lbs (167.4 kg)



**QUADRA™ SEATING SYSTEM**

PRODUCT DATA

**NOMINAL DIMENSIONS CONTINUED**

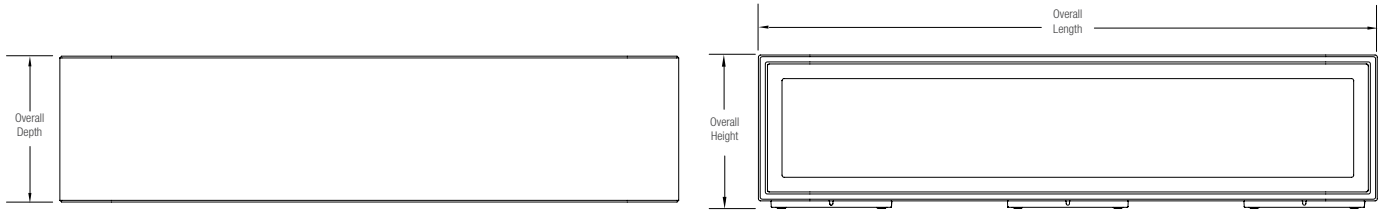

Shown with aperture front-to-back

MODEL	OVERALL LENGTH	OVERALL DEPTH	OVERALL HEIGHT	WEIGHT
SBQUA-72S	72.1" (1831 mm)	17" (432 mm)	17.9" (455 mm)	491 lbs (222.7 kg)

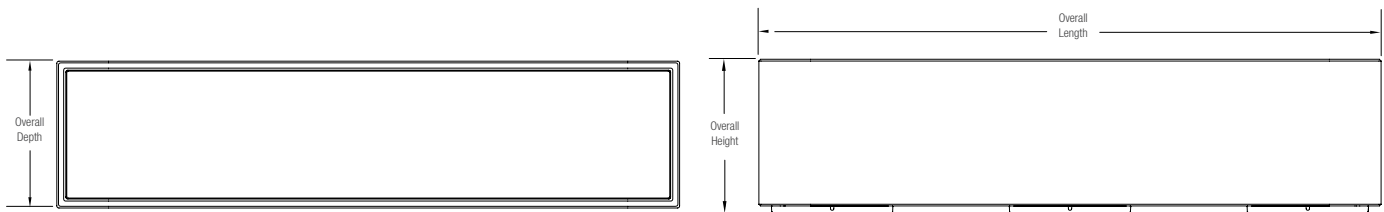

Shown with aperture top-to-bottom (aluminum inset configuration)

MODEL	OVERALL LENGTH	OVERALL DEPTH	OVERALL HEIGHT	WEIGHT
SBQUA-72A	72.1" (1831 mm)	17" (432 mm)	17.8" (452 mm)	566 lbs (257.7 kg)
SBQUA-72T	72.1" (1831 mm)	17" (432 mm)	17.8" (452 mm)	627 lbs (329.7 kg)
SBQUA-72W	72.1" (1831 mm)	17" (432 mm)	17.8" (452 mm)	566 lbs (257 kg)

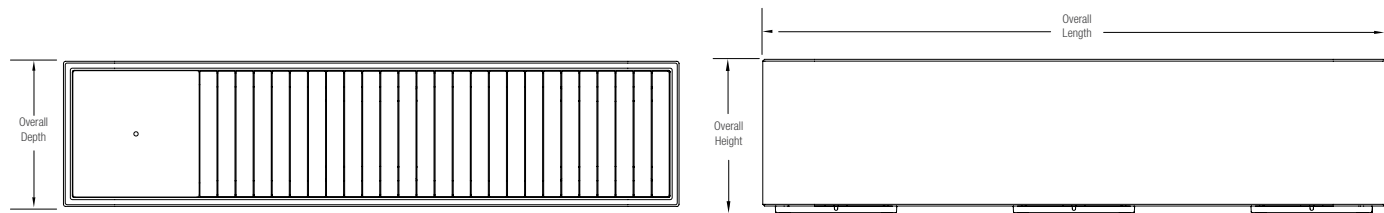

Shown with aperture top-to-bottom (planter configuration with Teak seat inset)

MODEL	OVERALL LENGTH	OVERALL DEPTH	OVERALL HEIGHT	WEIGHT
SBQUA-72AP	72.1" (1831 mm)	17" (432 mm)	17.8" (452 mm)	564 lbs (255 kg)
SBQUA-72TP	72.1" (1831 mm)	17" (432 mm)	17.8" (452 mm)	609 lbs (276 kg)
SBQUA-72WP	72.1" (1831 mm)	17" (432 mm)	17.8" (452 mm)	564 lbs (255 kg)



# QUADRA™ SEATING SYSTEM

PRODUCT DATA

## TENSL UHPC INSET SURFACE PATTERN OPTIONS

NO PATTERN

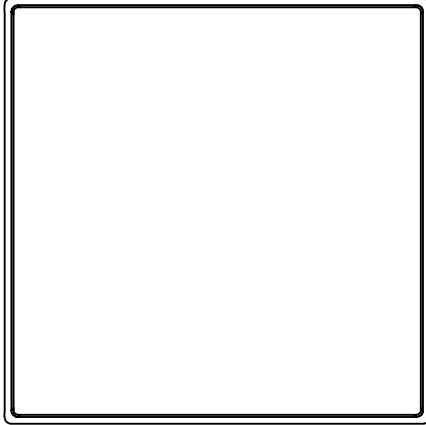

BIAS

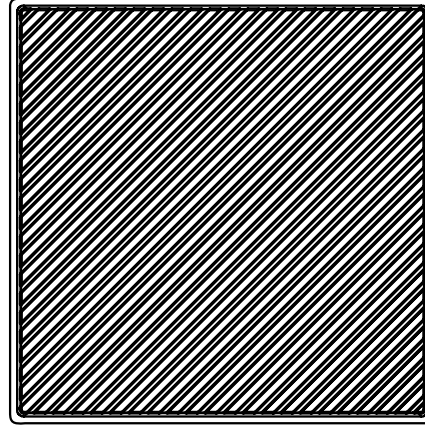

## MODEL NUMBER AND DESCRIPTION

MODEL	DESCRIPTION
SBQUA-17S	Quadra Seating System, 17", TENSL UHPC casting with front-to-back aperture, no inset
SBQUA-17A	Quadra Seating System, 17", TENSL UHPC casting with powdercoated aluminum inset
SBQUA-17T	Quadra Seating System, 17", TENSL UHPC casting with TENSL UHPC inset
SBQUA-17W	Quadra Seating System, 17", TENSL UHPC casting with FSC® Recycled 100% Teak hardwood slat inset
SBQUA-17P	Quadra Seating System, 17", TENSL UHPC casting with planter liner
SBQUA-48S	Quadra Seating System, 48", TENSL UHPC casting with front-to-back aperture, no inset
SBQUA-48A	Quadra Seating System, 48", TENSL UHPC casting with powdercoated aluminum inset
SBQUA-48T	Quadra Seating System, 48", TENSL UHPC casting with TENSL UHPC inset
SBQUA-48W	Quadra Seating System, 48", TENSL UHPC casting with FSC® Recycled 100% Teak hardwood slat inset
SBQUA-48P	Quadra Seating System, 48", TENSL UHPC casting with planter liner
SBQUA-72S	Quadra Seating System, 72", TENSL UHPC casting with front-to-back aperture, no inset
SBQUA-72A	Quadra Seating System, 72", TENSL UHPC casting with powdercoated aluminum inset
SBQUA-72T	Quadra Seating System, 72", TENSL UHPC casting with TENSL UHPC inset
SBQUA-72W	Quadra Seating System, 72", TENSL UHPC casting with FSC® Recycled 100% Teak hardwood slat inset
SBQUA-72AP	Quadra Seating System, 72", TENSL UHPC casting with powdercoated aluminum and planter liner insets
SBQUA-72TP	Quadra Seating System, 72", TENSL UHPC casting with TENSL UHPC and planter liner insets
SBQUA-72WP	Quadra Seating System, 72", TENSL UHPC casting with FSC® Recycled 100% Teak hardwood slat and planter liner insets



## QUADRA™ SEATING SYSTEM

PRODUCT DATA

### ENVIRONMENTAL CONSIDERATIONS

- Please refer to the Quadra Seating System Environmental Data Sheet for detailed environmental impact information.
- Quadra modules are composed primarily of natural materials local to manufacturing.
- All Quadra modules use a low energy, resource efficient manufacturing and curing process.
- All Quadra components disassemble at end of life and are fully recyclable.
- All Quadra wood is FSC® Recycled 100% Teak hardwood.
- Low maintenance and extremely long service life.
- Powdercoat finishes are no- or low-VOC, depending on color.
- Manufactured in the USA.

### PRODUCT OPTIONS

The following options are available for an upcharge:

Custom RAL powdercoat color

**LEAD TIME:** Please contact us to discuss your specific timing requirements.

**PRICING:** Please contact us at **800.451.0410** or **sales@forms-surfaces.com**. At Forms+Surfaces, we design, manufacture and sell our products directly to you. Our sales team is available to assist you with questions about our products, requests for quotes, and orders. Territory Managers are located worldwide to assist with the front-end specification and quoting process, and our in-house Project Sales Coordinators follow your project through from the time you place an order to shipment.

**TO ORDER SPECIFY:** Quantity, model, powdercoat color for frame, and freestanding or surface mount. Quote/Order Forms are available on our website to lead you through the specification process in a simple checkbox format.

**NOTE:** Because different computers, monitors, and printers render colors and textures differently, actual finishes may vary from those shown here.