

SOFT ROCK Lounge & Soft furniture

ORDERING GUIDELINES



- Proposed combinations are with glides suitable for soft floors (-). You can also order glides with felt for the hard floors (+). In this case, you should add 3 mm to the lounge seater height.
- Armrests can be plain or with built-in electricity solutions – power sockets or USB ports.
- **Please plan the location of the armrests with respect to the existing sockets on the site.**

PROPOSED COMBINATIONS

DIMENSIONS OF THE STRAIGHT TWO-SIDED SEATER COMBINATIONS

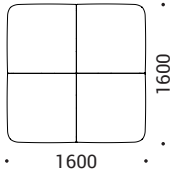

H = 400

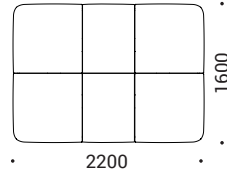

H = 400

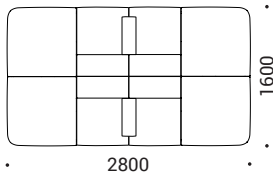

H = 690

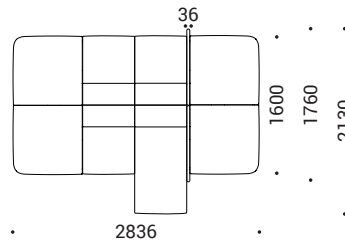

H = 713

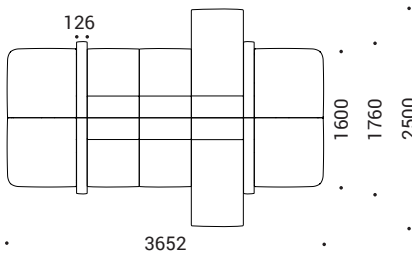

H = 690

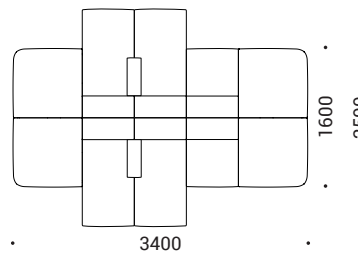

H = 690

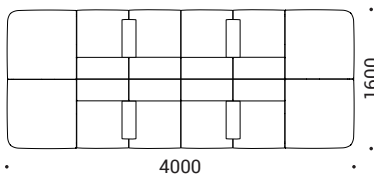

H = 690

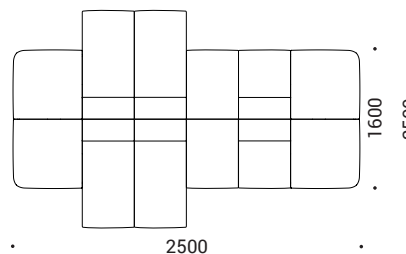

H = 690

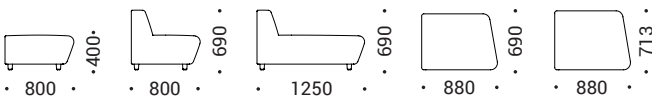

All dimensions are in millimetres.

STRAIGHT TWO-SIDED SEATER COMBINATIONS



①	SRS101-S56-00	4 pcs.
②	SRS000	4 pcs.

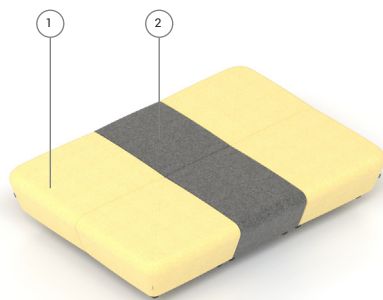

①	SRS101-S45-00	4 pcs.
②	SRS001-S17-000	2 pcs.
③	SRS000	6 pcs.

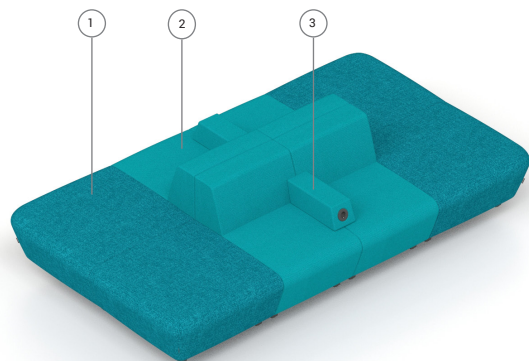

①	SRS101-L02-00	4 pcs.
②	SRS002-L03-000	4 pcs.
③	SRS303-L03-EU	2 pcs.
④	SRS000	8 pcs.

Proposed electricity solution*:

ZZZ346/ZCH001/ZUS049	1 pc.
ZZZ348/ZUS051	2 pcs.
ZZZ366	1 pc.

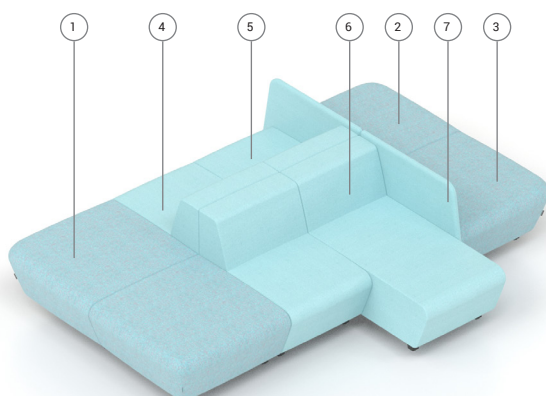

①	SRS101-S56-00	2 pcs.
②	SRS101-S56-10	1 pc.
③	SRS101-S56-01	1 pc.
④	SRS002-S55-000	2 pcs.
⑤	SRS002-S55-100	1 pc.
⑥	SRS003-S55-001	1 pc.
⑦	SRS403-S55	2 pcs.
⑧	SRS000	6 pcs.

* Assuming that the socket is on the ground and in the centre of the combination.

STRAIGHT TWO-SIDED SEATER COMBINATIONS

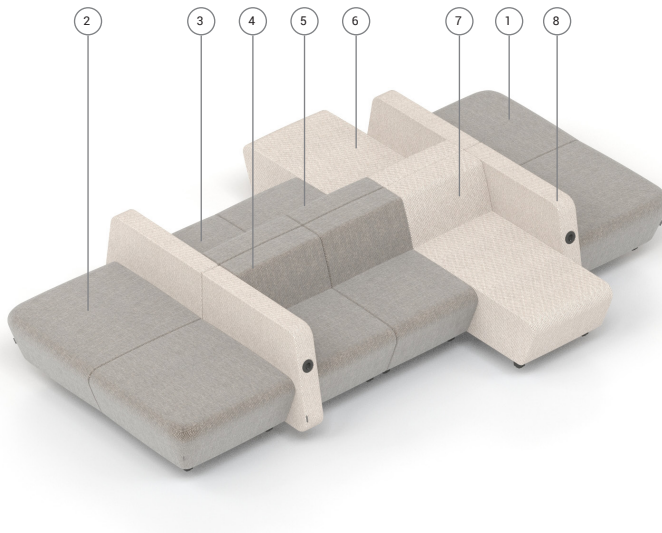

①	SRS101-AD5-10	2 pcs.
②	SRS101-AD5-01	2 pcs.
③	SRS002-AD5-100	1 pc.
④	SRS002-AD5-001	1 pc.
⑤	SRS002-AD5-000	2 pcs.
⑥	SRS003-AD8-100	1 pc.
⑦	SRS003-AD8-001	1 pc.
⑧	SRS209-AD8-EU	4 pcs.
⑨	SRS000	6 pcs.

Proposed electricity solution*:

ZZZ346/ZCH001/ZUS049	1 pc.
ZZZ349/ZUS052	4 pcs.
ZZZ368	1 pc.

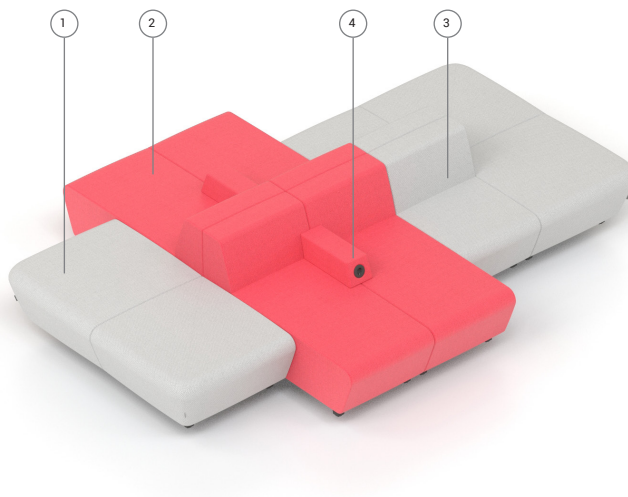

①	SRS101-C11-0	4 pcs.
②	SRS003-C06-000	4 pcs.
③	SRS002-C11-000	2 pcs.
④	SRS303-C06-EU	2 pcs.
⑤	SRS000	10 pcs.

Proposed cable management solution*:

ZZZ346/ZCH001/ZUS049	1 pc.
ZZZ348/ZUS051	2 pcs.
ZZZ366	1 pc.

* Assuming that the socket is on the ground and in the centre of the combination.

STRAIGHT TWO-SIDED SEATER COMBINATIONS

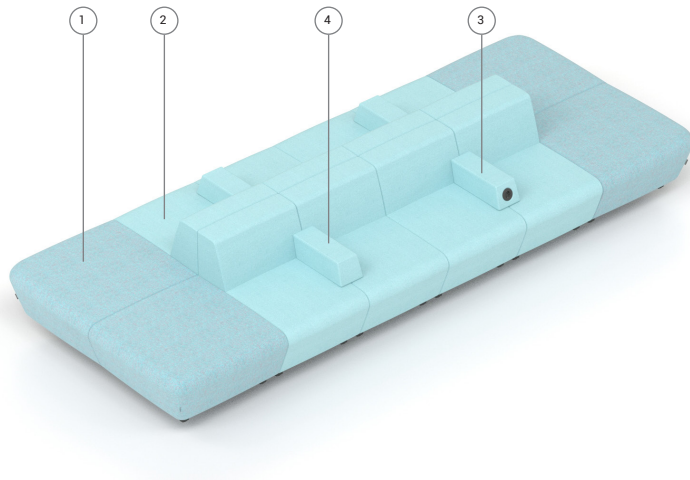

①	SRS101-S56-00	4 pcs.
②	SRS002-S56-000	8 pcs.
③	SRS303-S55-EU	2 pcs.
④	SRS301-S55	2 pcs.
⑤	SRS000	12 pcs.

Proposed electricity solution*:

ZZZ346/ZCH001/ZUS049	1 pc.
ZZZ348/ZUS051	2 pcs.
ZZZ366	1 pc.

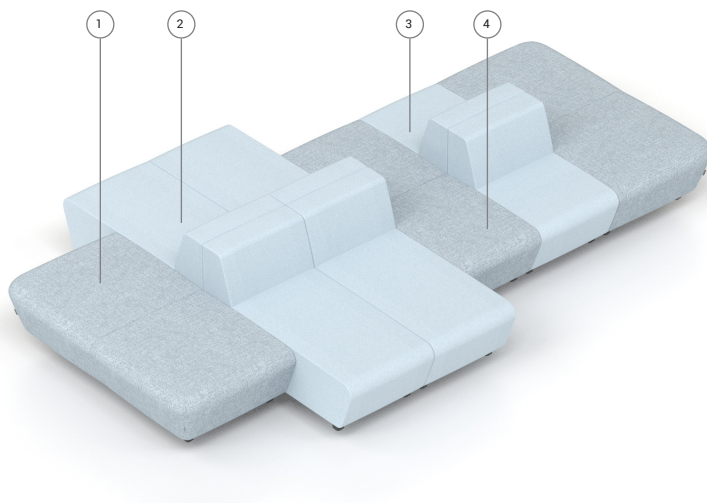

①	SRS101-L06-00	4 pcs.
②	SRS003-L07-000	4 pcs.
③	SRS002-L07-000	2 pcs.
④	SRS001-L06-000	2 pcs.
⑤	SRS000	12 pcs.

* Assuming that the socket is on the ground and in the centre of the combination.

DIMENSIONS OF THE CURVED TWO-SIDED SEATER COMBINATIONS

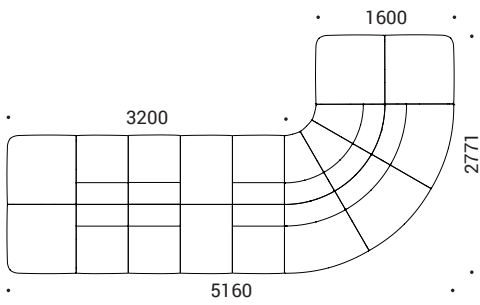

H = 690

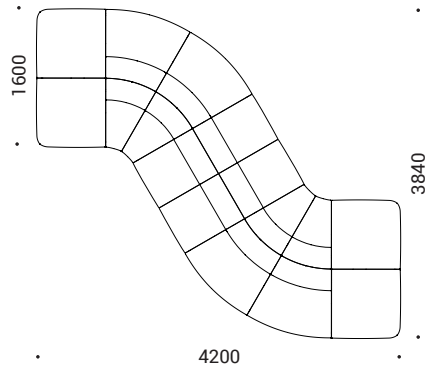

H = 690

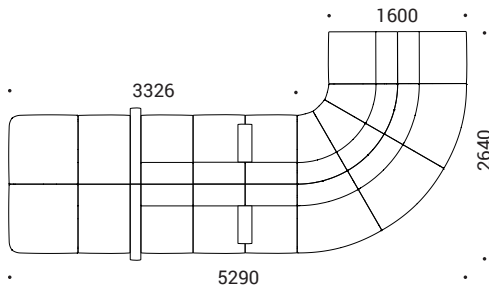

H = 690

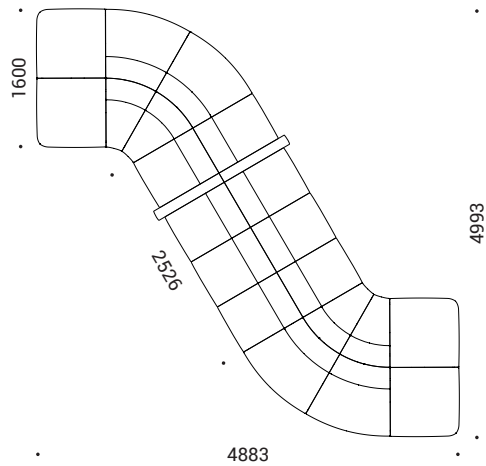

H = 690

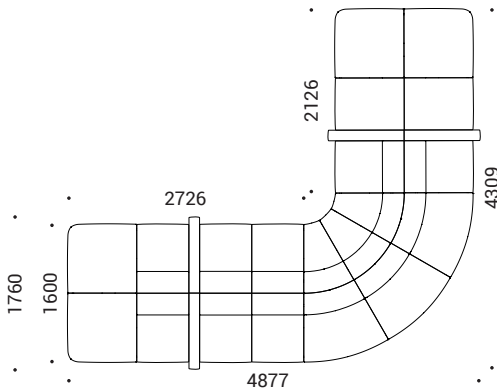

H = 690

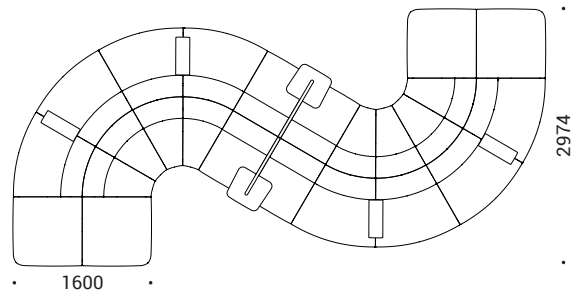

H = 1263

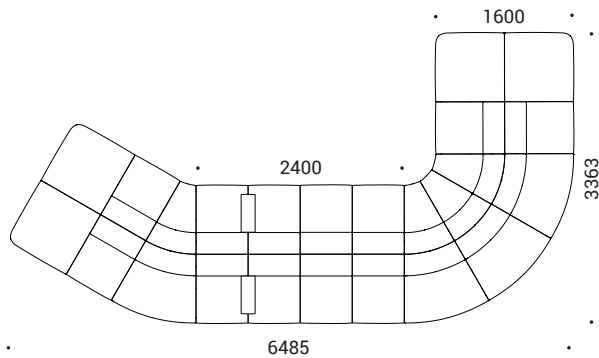

H = 690

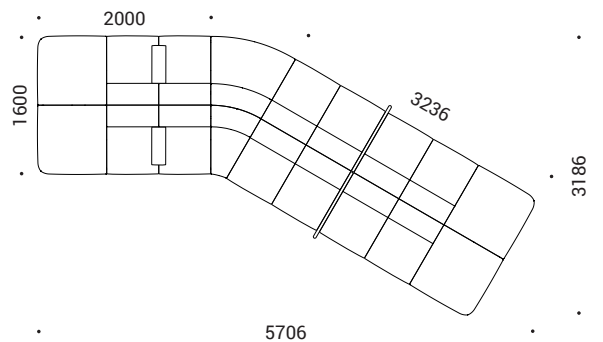

H = 713

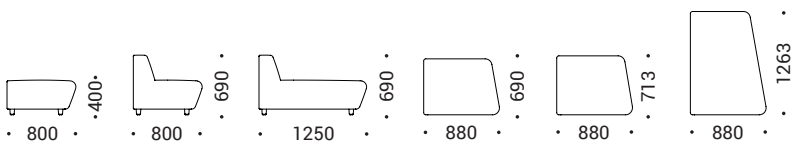

All dimensions are in millimetres.

CURVED TWO-SIDED SEATER COMBINATIONS

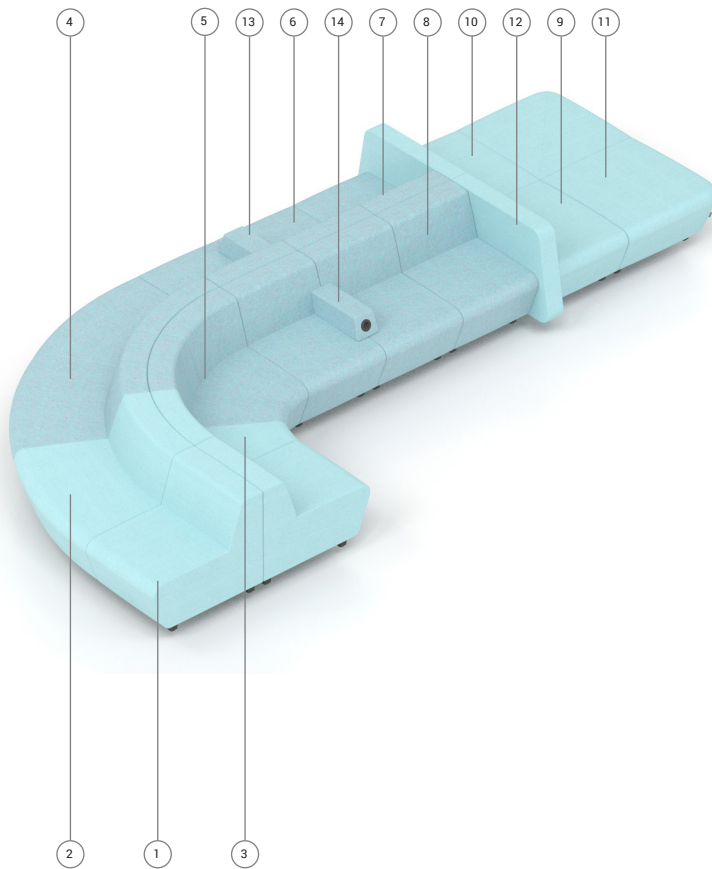

①	SRS002-S55-000	2 pcs.
②	SRS102-S55-00	1 pc.
③	SRS103-S55-00	1 pc.
④	SRS102-S56-00	2 pcs.
⑤	SRS103-S56-00	2 pcs.
⑥	SRS002-S56-000	4 pcs.
⑦	SRS002-S56-100	1 pc.
⑧	SRS002-S56-001	1 pc.
⑨	SRS001-S55-100	1 pc.
⑩	SRS001-S55-001	1 pc.
⑪	SRS101-S55-00	2 pcs.
⑫	SRS203-S55	2 pcs.
⑬	SRS301-S56	1 pc.
⑭	SRS303-S56-EU	1 pc.
⑮	SRS000	15 pcs.

Proposed electricity solution*:

ZZZ347/ZCH002/ZUS050	1 pc.
ZZZ348/ZUS051	2 pcs.
ZZZ366	1 pc.

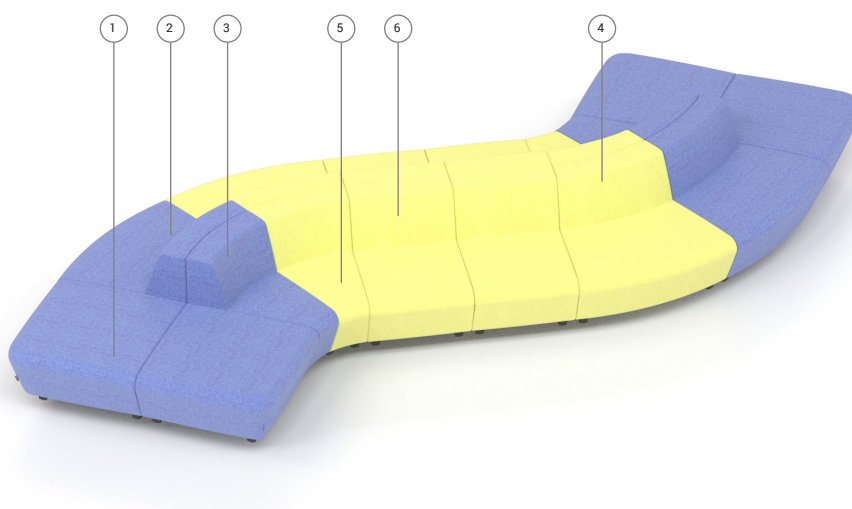

①	SRS101-S68-00	4 pcs.
②	SRS102-S68-00	2 pcs.
③	SRS103-S68-00	2 pcs.
④	SRS102-S46-00	2 pcs.
⑤	SRS103-S46-00	2 pcs.
⑥	SRS002-S46-000	4 pcs.
⑦	SRS000	16 pcs.

* Assuming that the socket is on the ground and in the centre of the combination.

CURVED TWO-SIDED SEATER COMBINATIONS

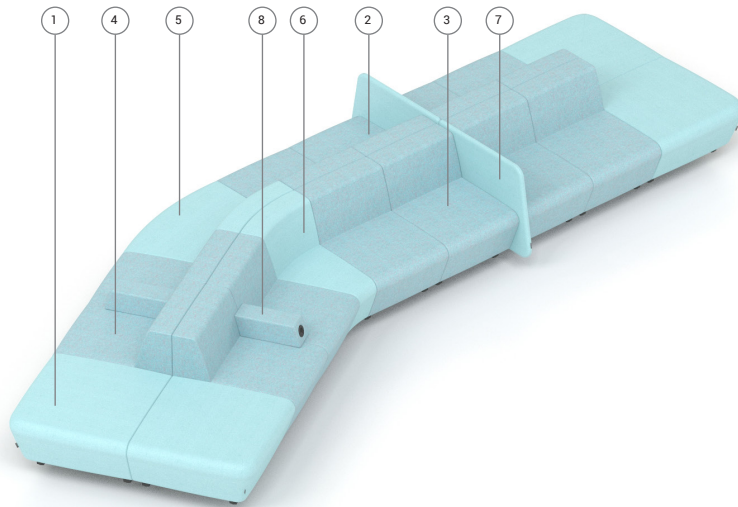

①	SRS101-S55-00	4 pcs.
②	SRS002-S56-100	2 pcs.
③	SRS002-S56-001	2 pcs.
④	SRS002-S56-000	8 pcs.
⑤	SRS102-S55-00	1 pc.
⑥	SRS103-S55-00	1 pc.
⑦	SRS403-S55	2 pcs.
⑧	SRS303-S55-EU	2 pcs.
⑨	SRS000	14 pcs.

Proposed electricity solution*:

ZZZ347/ZCH002/ZUS050	1 pc.
ZZZ348/ZUS051	2 pcs.
ZZZ366	1 pc.

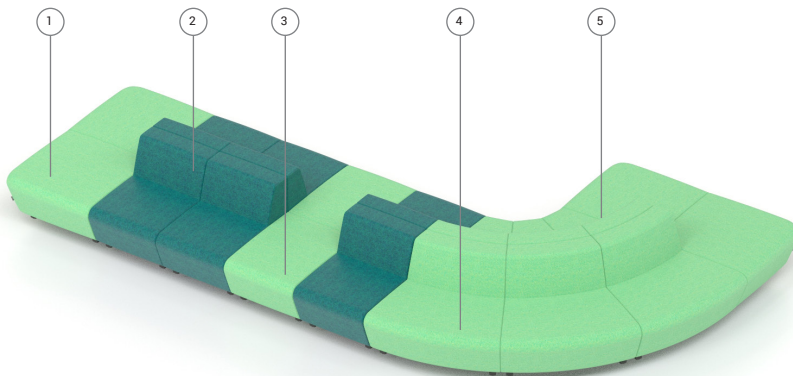

①	SRS101-S53-00	4 pcs.
②	SRS002-S50-000	6 pcs.
③	SRS001-S53-000	2 pcs.
④	SRS102-S53-00	3 pcs.
⑤	SRS103-S53-00	3 pcs.
⑥	SRS000	18 pcs.

* Assuming that the socket is on the ground and in the centre of the combination.

CURVED TWO-SIDED SEATER COMBINATIONS

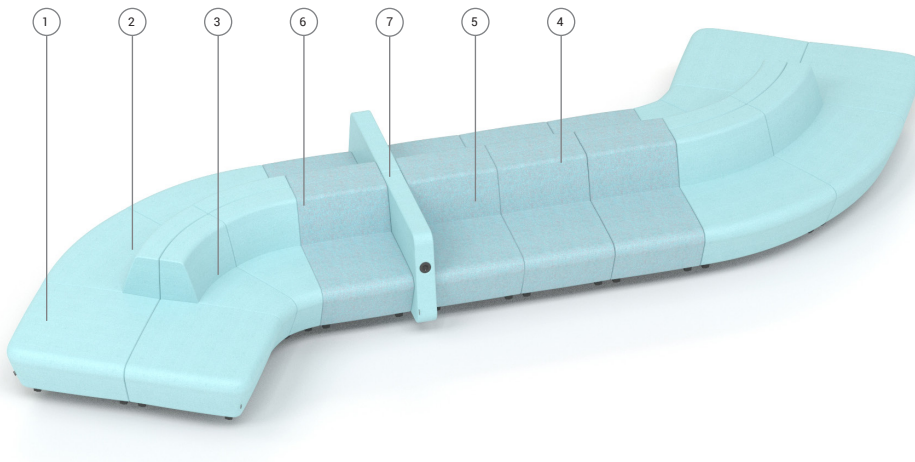

①	SRS101-S55-00	4 pcs.
②	SRS102-S55-00	4 pcs.
③	SRS103-S55-00	4 pcs.
④	SRS002-S56-000	4 pcs.
⑤	SRS002-S56-100	2 pcs.
⑥	SRS002-S56-001	2 pcs.
⑦	SRS209-S55-EU	2 pcs.
⑧	SRS000	18 pcs.

Proposed electricity solution*:

ZZZ346/ZCH001/ZUS049	1 pc.
ZZZ348/ZUS051	2 pcs.
ZZZ366	1 pc.

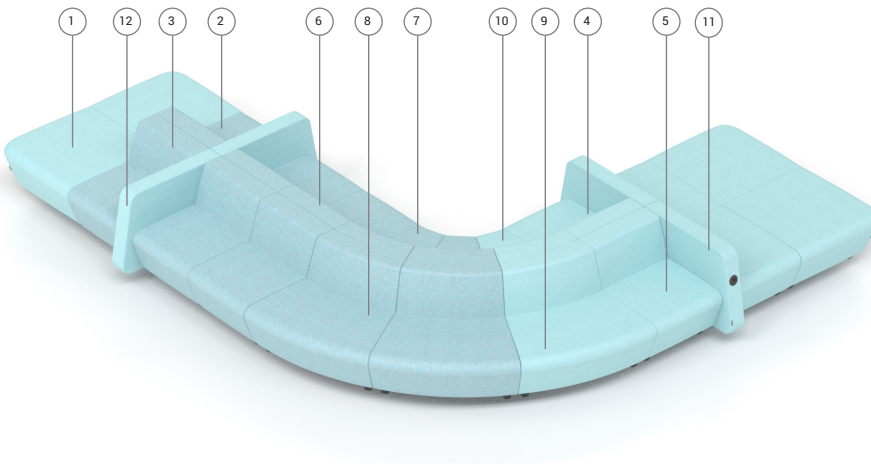

①	SRS101-S55-00	4 pcs.
②	SRS002-S56-100	2 pcs.
③	SRS002-S56-001	2 pcs.
④	SRS002-S55-100	1 pc.
⑤	SRS002-S55-001	1 pc.
⑥	SRS002-S56-000	2 pcs.
⑦	SRS103-S56-00	2 pcs.
⑧	SRS102-S56-00	2 pcs.
⑨	SRS102-S55-00	1 pc.
⑩	SRS103-S55-00	1 pc.
⑪	SRS209-S55-EU	2 pcs.
⑫	SRS203-S55	2 pcs.
⑬	SRS000	16 pcs.

Proposed electricity solution*:

ZZZ346/ZCH001/ZUS049	1 pc.
ZZZ350/ZUS053	2 pcs.
ZZZ366	1 pc.

* Assuming that the socket is on the ground and in the centre of the combination.

CURVED TWO-SIDED SEATER COMBINATIONS

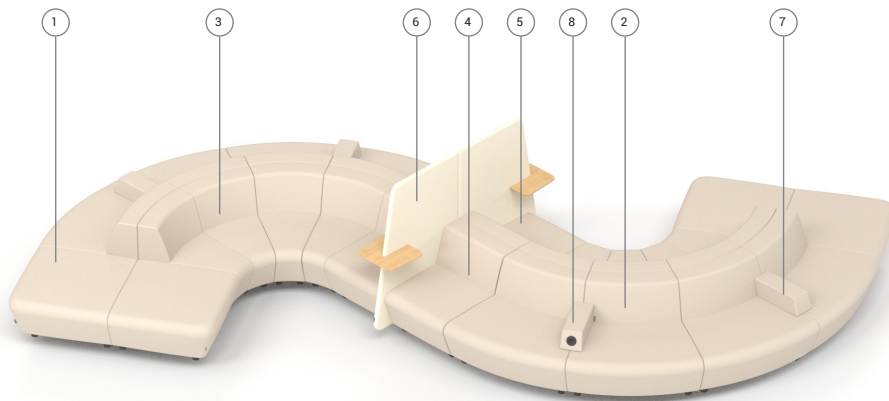

①	SRS101- D17-00	4 pcs.
②	SRS102- D17-00	8 pcs.
③	SRS103- D17-00	8 pcs.
④	SRS002- D17-100	2 pcs.
⑤	SRS002-D17-001	2 pcs.
⑥	SRS407-D16AAA	2 pcs.
⑦	SRS301- D17	2 pcs.
⑧	SRS303- D17-EU	2 pcs.
⑨	SRS000	22 pcs.

Proposed electricity solution*:

ZZZ346/ZCH001/ZUS049	1 pc.
ZZZ349/ZUS052	2 pcs.
ZZZ366	1 pc.

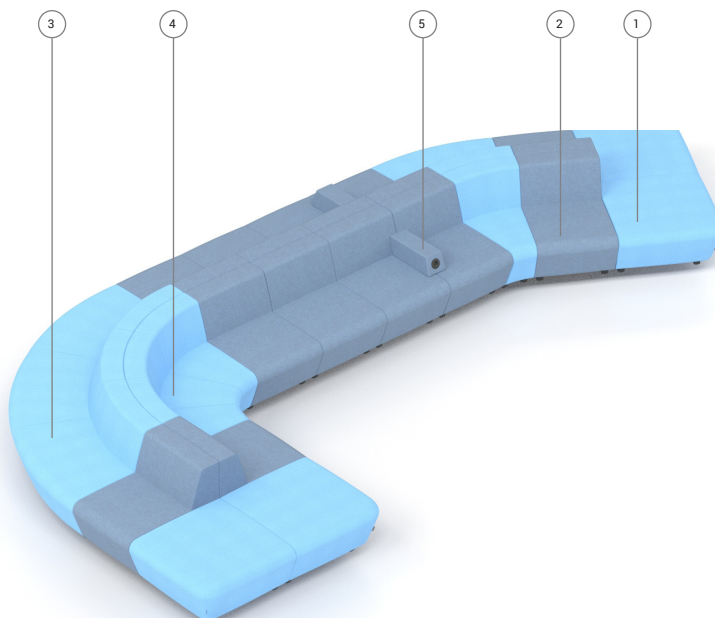

①	SRS101-GT1-00	4 pcs.
②	SRS002-GT9-000	12 pcs.
③	SRS102-GT1-00	4 pcs.
④	SRS103-GT1-00	4 pcs.
⑤	SRS303-GT9-EU	2 pcs.
⑥	SRS000	24 pcs.

Proposed electricity solution*:

ZZZ346/ZCH001/ZUS049	1 pc.
ZZZ348/ZUS051	2 pcs.
ZZZ366	1 pc.

* Assuming that the socket is on the ground and in the centre of the combination.

DIMENSIONS OF THE STRAIGHT ONE-SIDED SEATER COMBINATIONS

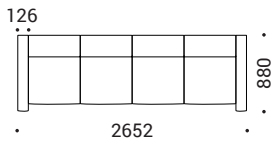

H = 690

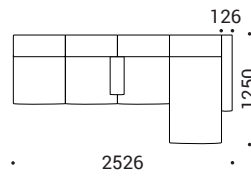

H = 690

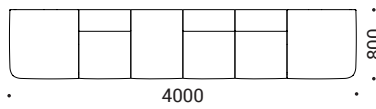

H = 690

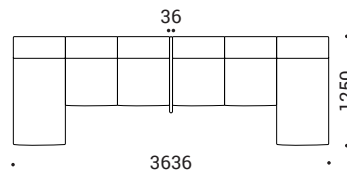

H = 713

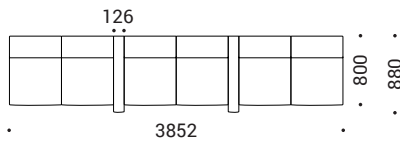

H = 690

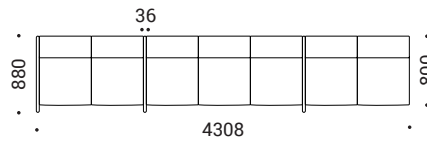

H = 1263

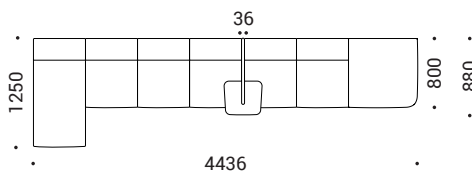

H = 1263

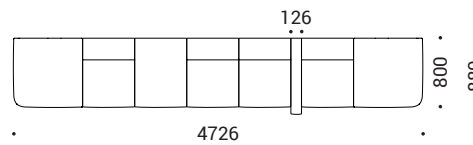

H = 690

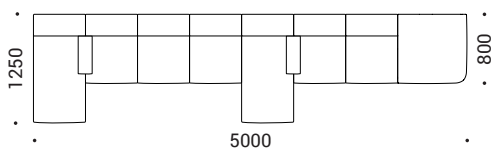

H = 690

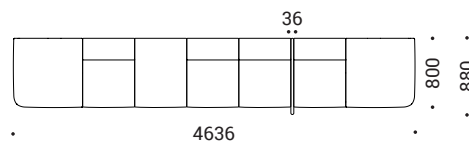

H = 713

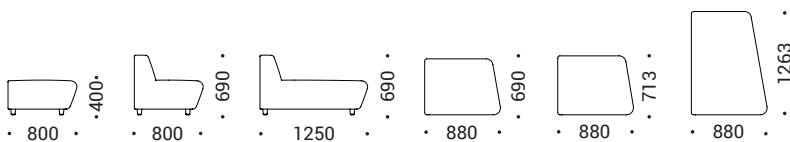

All dimensions are in millimetres.

STRAIGHT ONE-SIDED SEATER COMBINATIONS

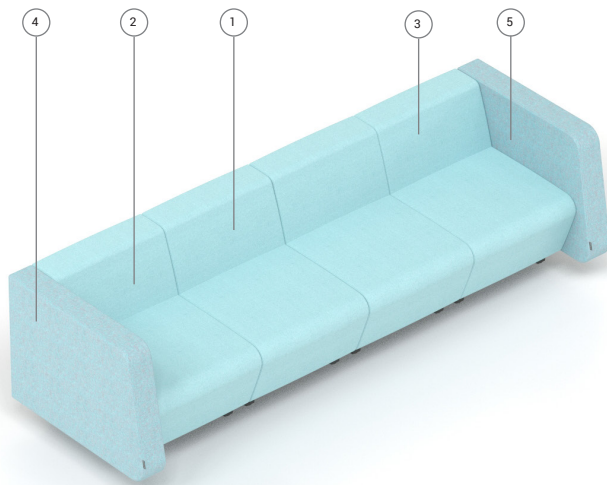

①	SRS002-S55-000	2 pcs.
②	SRS002-S55-100	1 pc.
③	SRS002-S55-001	1 pc.
④	SRS201-S56	1 pc.
⑤	SRS202-S56	1 pc.
⑥	SRS000	3 pcs.

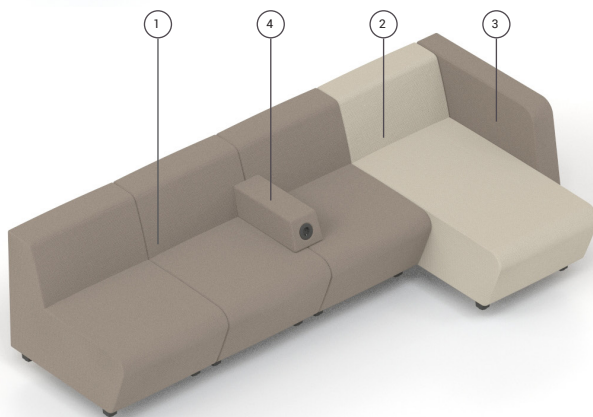

①	SRS002-L21-000	3 pcs.
②	SRS003-L15-001	1 pc.
③	SRS202-L21	1 pc.
④	SRS303-L21-EU	1 pc.
⑤	SRS000	3 pcs.

Proposed electricity solution*:

ZZZ346/ZCH001/ZUSO49 1 pc.

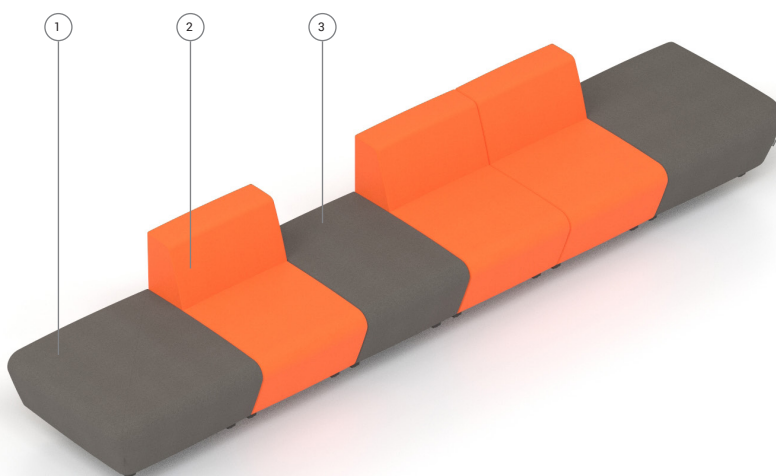

①	SRS101-GU9-00	2 pcs.
②	SRS002-GT5-000	3 pcs.
③	SRS001-GU9-000	1 pc.
④	SRS000	5 pcs.

* Assuming that the socket is on the ground or wall and in the centre of the combination.

STRAIGHT ONE-SIDED SEATER COMBINATIONS

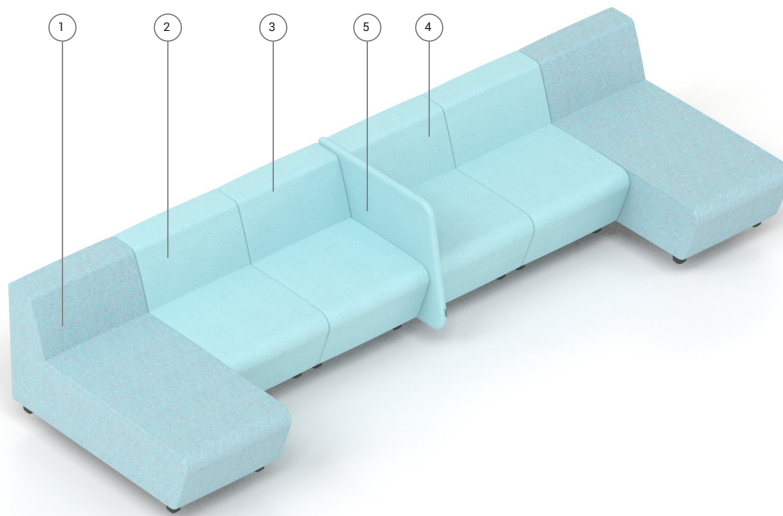

①	SRS003-S56-000	2 pcs.
②	SRS002-S55-000	2 pcs.
③	SRS002-S55-100	1 pc.
④	SRS002-S55-001	1 pc.
⑤	SRS403-S55	1 pc.
⑥	SRS000	4 pcs.

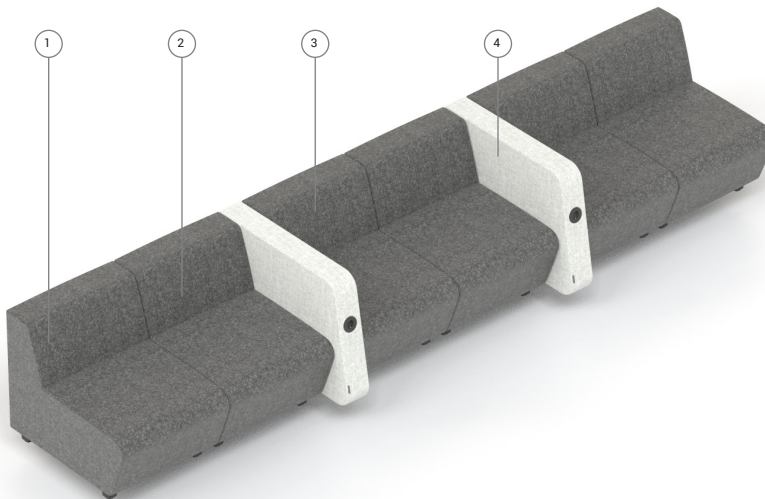

①	SRS002-S17-000	2 pcs.
②	SRS002-S17-100	2 pcs.
③	SRS002-S17-001	2 pcs.
④	SRS209-S08-EU	2 pcs.
⑤	SRS000	3 pcs.

Proposed electricity solution*:

ZZZ346/ZCH001/ZUS049	1 pc.
ZZZ348/ZUS051	2 pcs.
ZZZ366	1 pc.

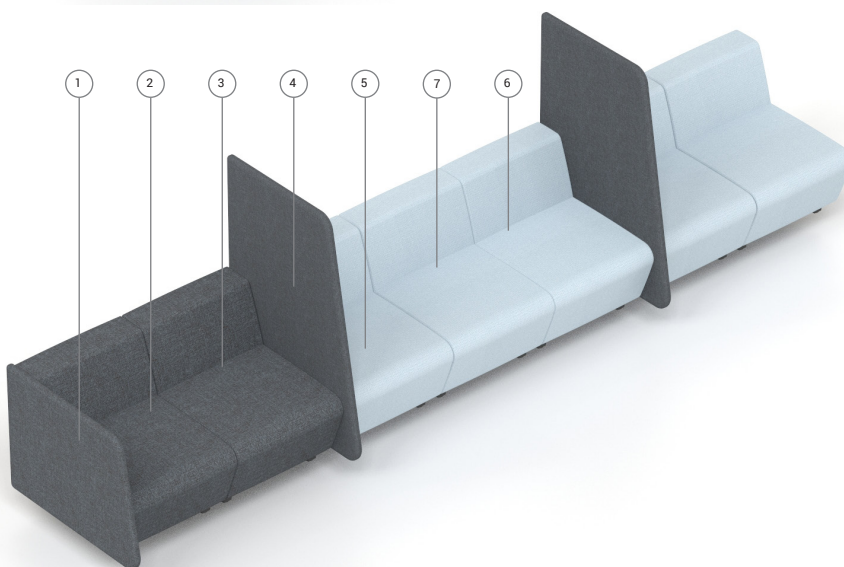

①	SRS401-L20	1 pc.
②	SRS002-L20-100	1 pc.
③	SRS002-L20-001	1 pc.
④	SRS406-L20	2 pcs.
⑤	SRS002-L07-100	2 pcs.
⑥	SRS002-L07-001	1 pc.
⑦	SRS002-L07-000	2 pcs.
⑧	SRS000	4 pcs.

* Assuming that the socket is on the ground or wall and in the centre of the combination.

STRAIGHT ONE-SIDED SEATER COMBINATIONS

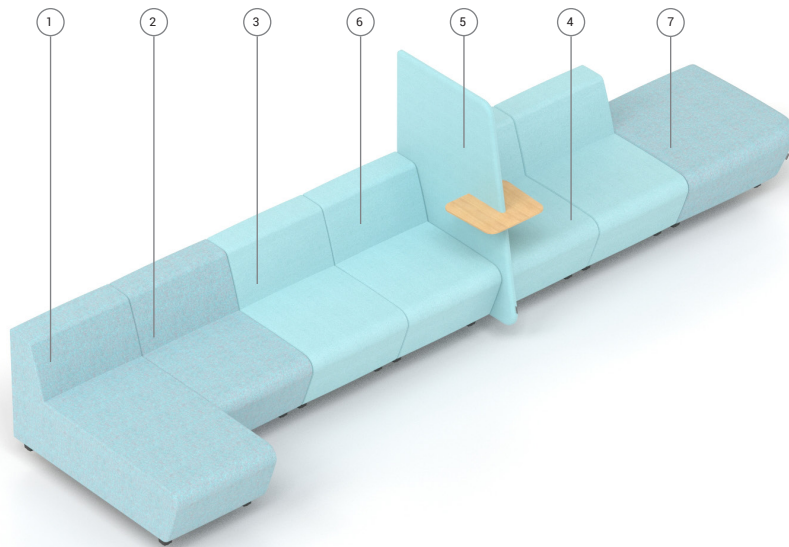

①	SRS003-S56-000	1 pc.
②	SRS002-S56-000	1 pc.
③	SRS002-S55-000	2 pcs.
④	SRS002-S55-100	1 pc.
⑤	SRS407-S55AAA	1 pc.
⑥	SRS002-S55-001	1 pc.
⑦	SRS101-S56-00	1 pc.
⑧	SRS000	5 pcs.

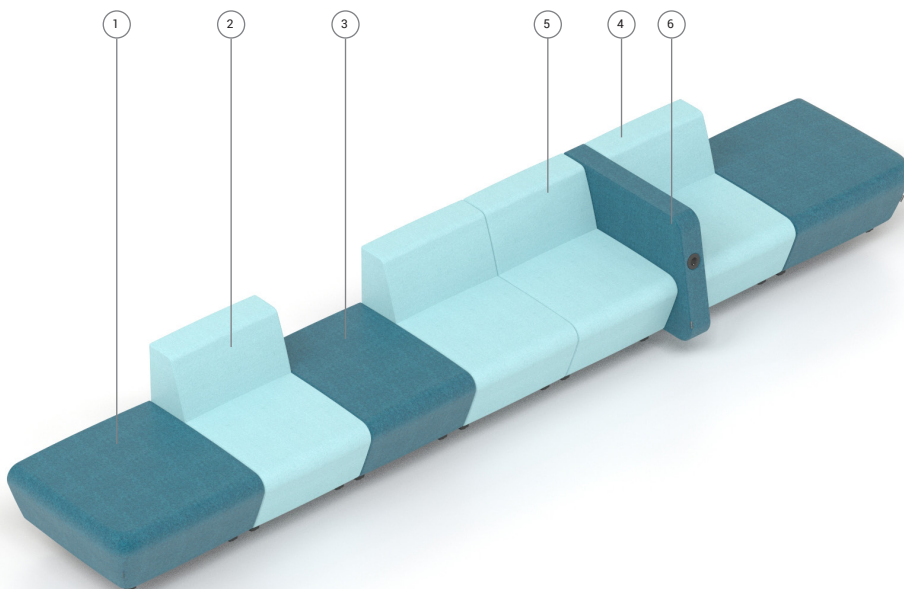

①	SRS101-S59-00	2 pcs.
②	SRS002-S55-000	2 pcs.
③	SRS001-S59-000	1 pc.
④	SRS002-S55-100	1 pc.
⑤	SRS002-S55-001	1 pc.
⑥	SRS209-S59-EU	1 pc.
⑦	SRS000	5 pcs.

Proposed electricity solution*:

ZZZ346/ZCH001/ZUS049 1pc.

* Assuming that the socket is on the ground or wall and in the centre of the combination.

STRAIGHT ONE-SIDED SEATER COMBINATIONS

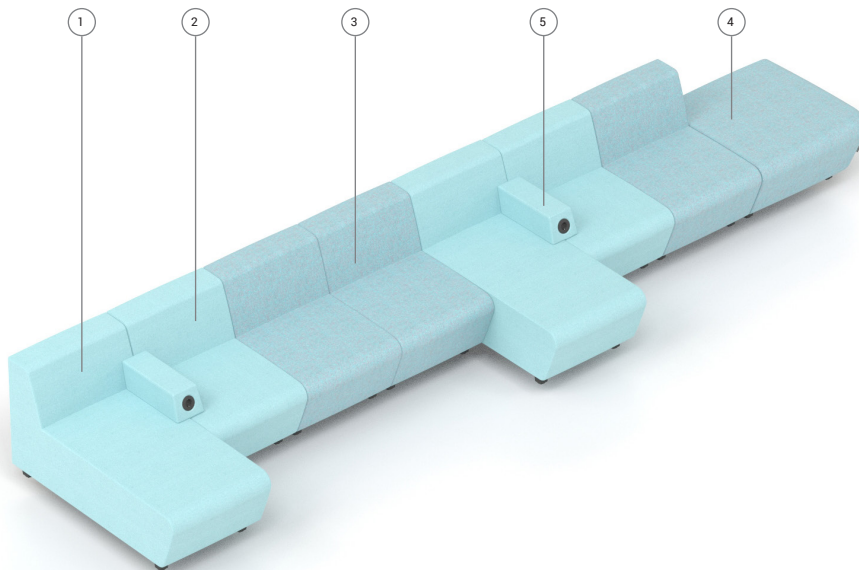

①	SRS003-S55-000	2 pcs.
②	SRS002-S55-000	2 pcs.
③	SRS002-S56-000	3 pcs.
④	SRS101-S56-00	1 pc.
⑤	SRS303-S55-EU	2 pcs.
⑥	SRS000	7 pcs.

Proposed cable management solution*:

ZZZ346/ZCH001/ZUS049	1 pc.
ZZZ348/ZUS051	1 pc.
ZZZ349/ZUS052	1 pc.
ZZZ366	1 pc.

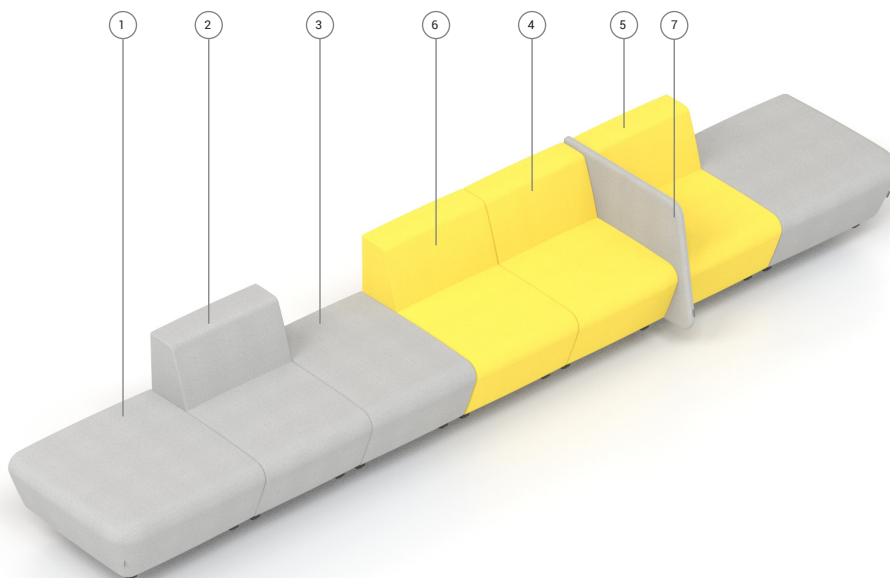

①	SRS101-GU2-00	2 pcs.
②	SRS002-GU2-000	1 pcs.
③	SRS001-GU2-00	1 pc.
④	SRS002-GP3-001	1 pc.
⑤	SRS002-GP3-100	1 pc.
⑥	SRS002-GP3-000	1 pc.
⑦	SRS403-GU2	1 pc.
⑧	SRS000	6 pcs.

* Assuming that the socket is on the ground or wall and in the centre of the combination.

DIMENSIONS OF THE CURVED ONE-SIDED SEATER COMBINATIONS

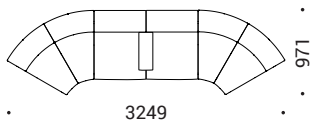

H = 690

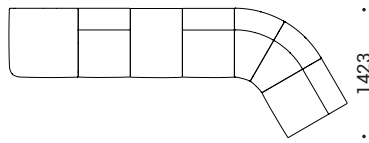

H = 690

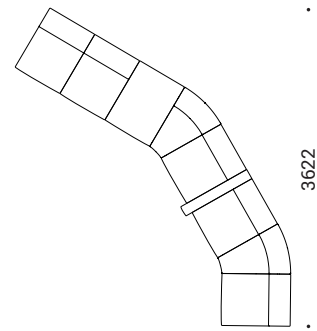

H = 690

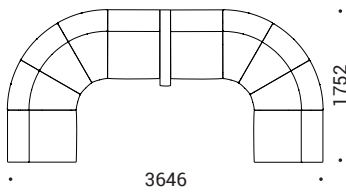

H = 690

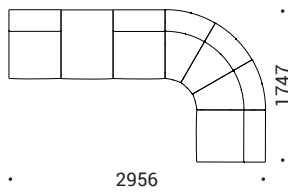

H = 690

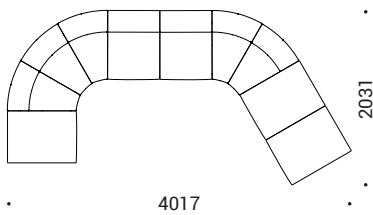

H = 690

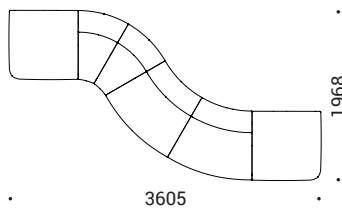

H = 690

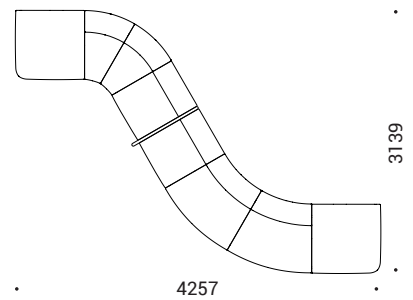

H = 713

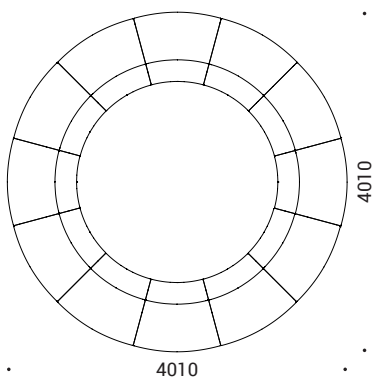

H = 690

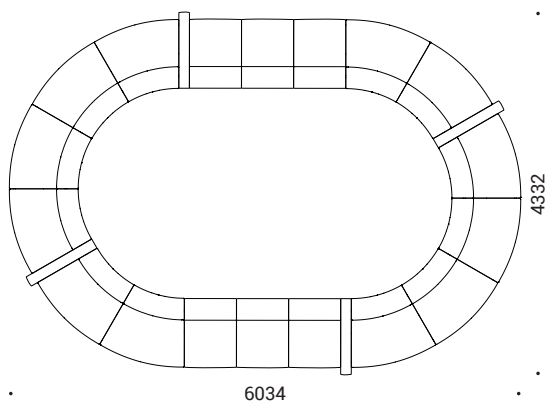

H = 690

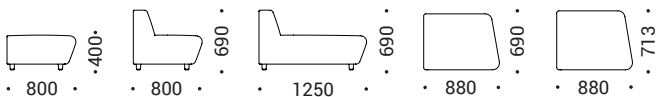

All dimensions are in millimetres.

CURVED ONE-SIDED SEATER COMBINATIONS

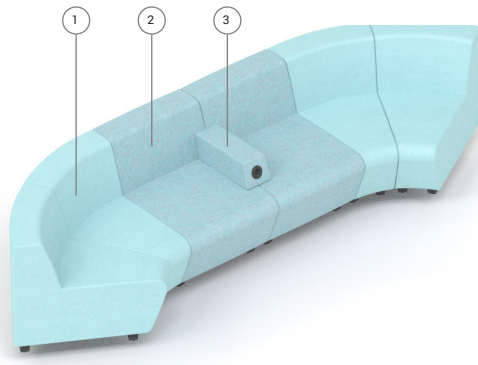

①	SRS103-S55-00	4 pcs.
②	SRS002-S56-000	2 pcs.
③	SRS303-S56-EU	1 pc.
④	SRS000	5 pcs.

Proposed electricity solution*:

ZZZ346/ZCH001/ZUS049 1 pc.

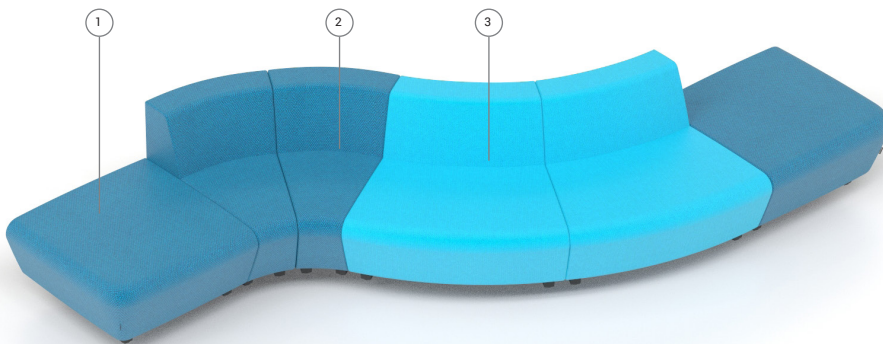

①	SRS101-C15-00	2 pcs.
②	SRS103-C15-00	2 pcs.
③	SRS102-C20-00	2 pcs.
④	SRS000	5 pcs.

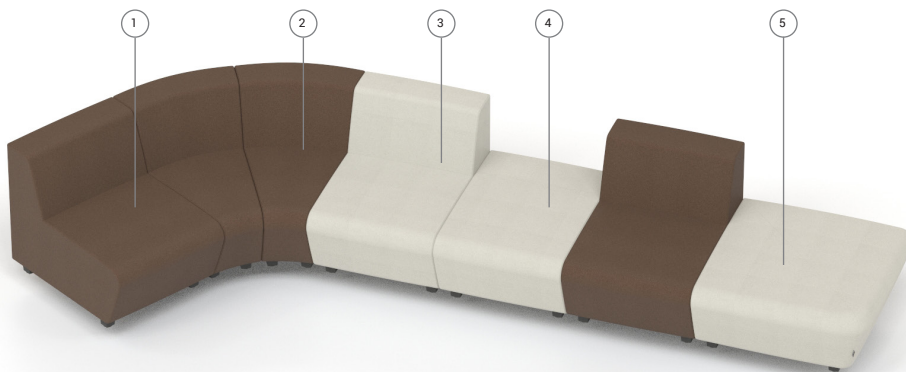

①	SRS002-GU8-000	2 pcs.
②	SRS103-GU8-00	2 pcs.
③	SRS002-GT4-000	1 pc.
④	SRS001-GT4-000	1 pc.
⑤	SRS101-GT4-00	1 pc.
⑥	SRS000	6 pcs.

* Assuming that the socket is on the ground or wall and in the centre of the combination.

CURVED ONE-SIDED SEATER COMBINATIONS

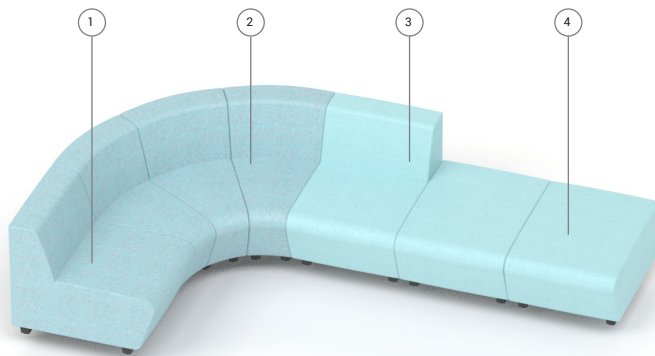

①	SRS002-S56-000	1 pc.
②	SRS103-S56-00	3 pcs.
③	SRS002-S55-000	1 pc.
④	SRS001-S55-000	2 pcs.
⑤	SRS000	6 pcs.

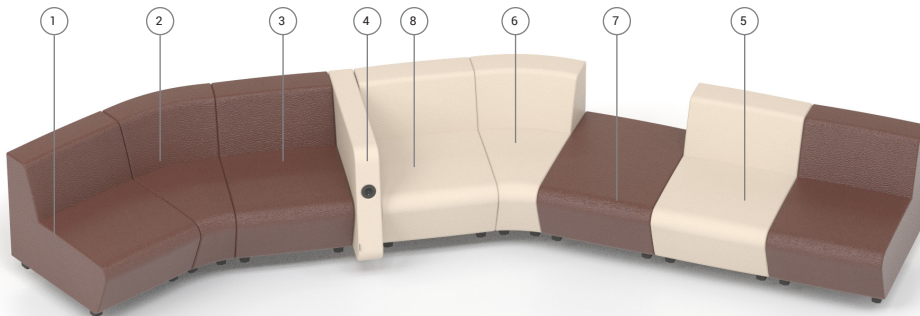

①	SRS002-D18-000	2 pcs.
②	SRS103-D18-00	1 pc.
③	SRS002-D18-001	1 pc.
④	SRS209-D17-EU	1 pc.
⑤	SRS002-D17-000	1 pc.
⑥	SRS103-D17-00	1 pc.
⑦	SRS001-D18-000	1 pc.
⑧	SRS002-D17-100	1 pc.
⑨	SRS000	6 pcs.

Proposed electricity solution*:

ZZZ346/ZCH001/ZUS049 1pc.

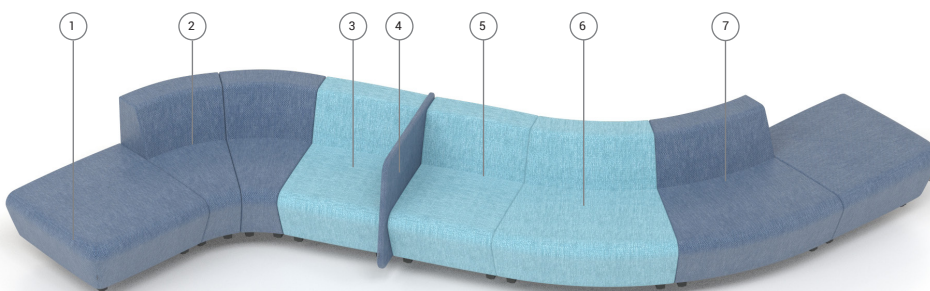

①	SRS101-AD4-00	2 pcs.
②	SRS103-AD4-00	2 pcs.
③	SRS002-AD6-001	1 pc.
④	SRS403-AD4	1 pc.
⑤	SRS002-AD6-100	1 pc.
⑥	SRS102-AD6-00	1 pc.
⑦	SRS102-AD4-00	1 pc.
⑧	SRS000	6 pcs.

* Assuming that the socket is on the ground or wall and in the centre of the combination.

CURVED ONE-SIDED SEATER COMBINATIONS

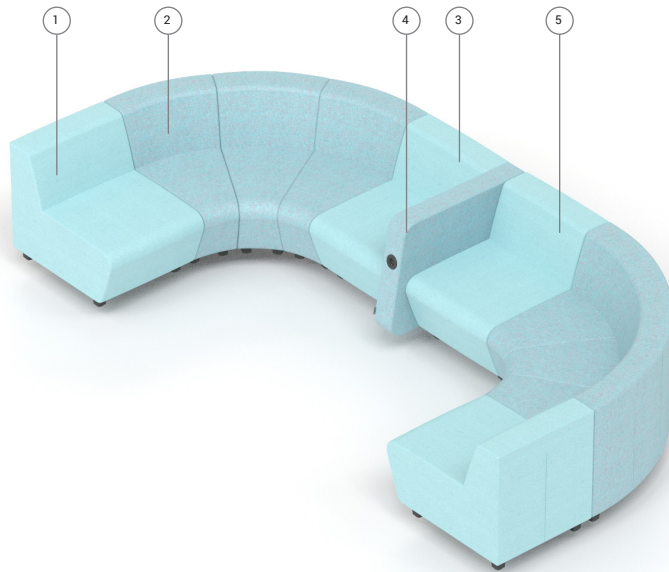

①	SRS002-S55-000	2 pcs.
②	SRS103-S56-00	6 pcs.
③	SRS002-S55-001	1 pc.
④	SRS209-S56-EU	1 pc.
⑤	SRS002-S55-100	1 pc.
⑥	SRS000	8 pcs.

Proposed electricity solution*:

ZZZ346/ZCH001/ZUS049 1 pc.

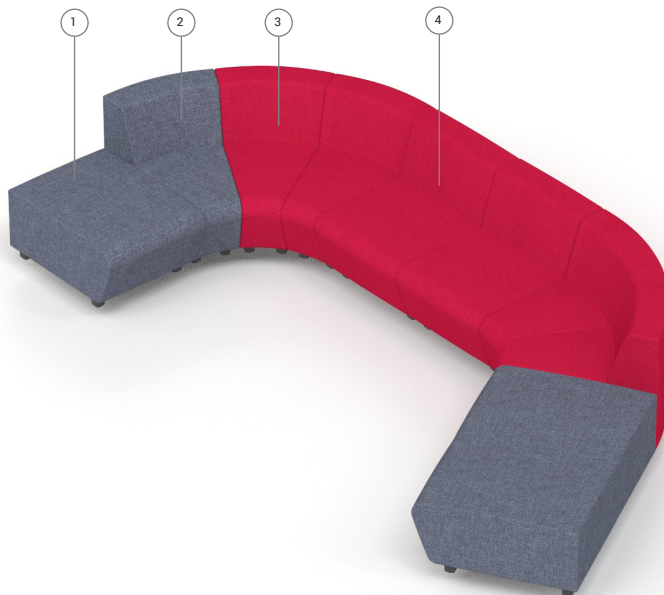

①	SRS001-L14-000	3 pcs.
②	SRS103-L14-00	1 pc.
③	SRS103-L19-00	4 pcs.
④	SRS002-L19-000	2 pcs.
⑤	SRS000	9 pcs.

* Assuming that the socket is on the ground or wall and in the centre of the combination.

CURVED ONE-SIDED SEATER COMBINATIONS

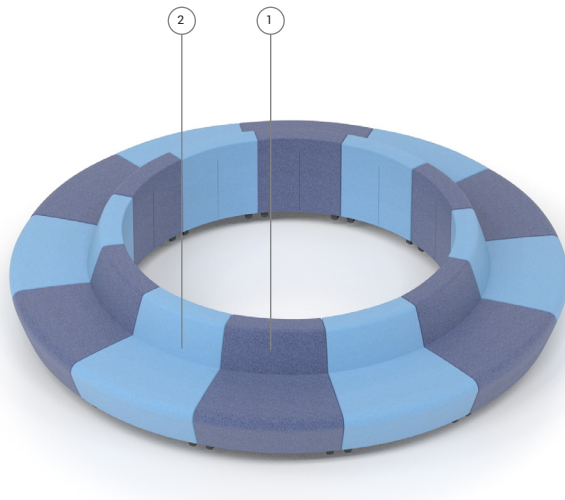

①	SRS102-S63-00	6 pcs.
②	SRS102-S62-00	6 pcs.
③	SRS000	12 pcs.

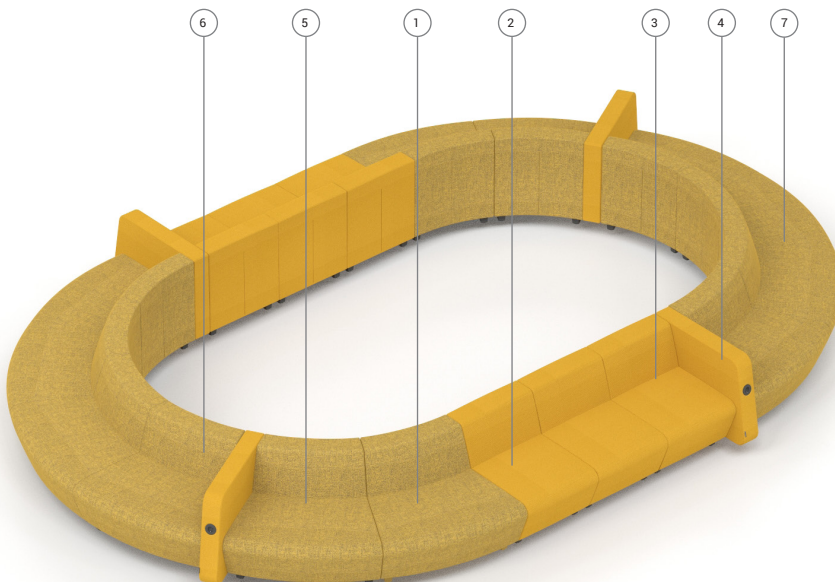

①	SRS102-L16-00	6 pcs.
②	SRS002-L17-000	4 pcs.
③	SRS002-L17-001	2 pcs.
④	SRS209-L17-EU	4 pcs.
⑤	SRS102-L16-10	4 pcs.
⑥	SRS102-L16-01	2 pcs.
⑦	SRS000	14 pcs.

Proposed electricity solution*:

ZZZ346/ZCH001/ZUS049	2 pcs.
ZZZ349/ZUS052	4 pcs.
ZZZ366	2 pcs.

* At least two sockets on the sides of the combination are needed for the proposed electricity solution.

PROPOSED COLOUR COMBINATIONS

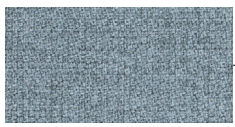

L06

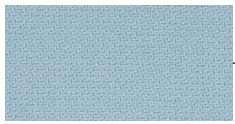

L07

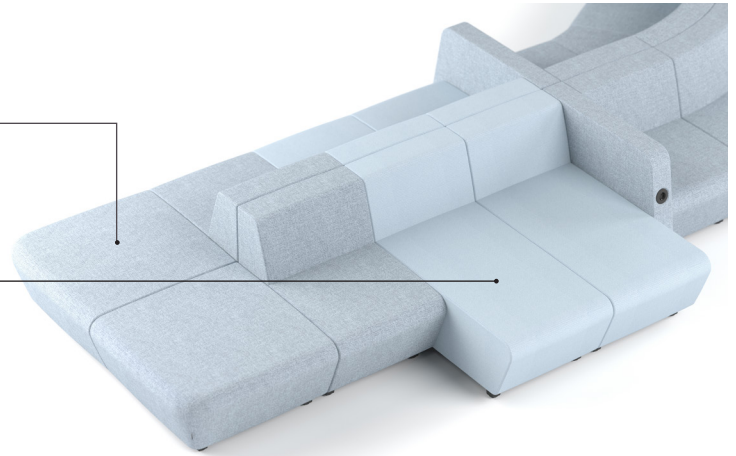

Step, Step Melange

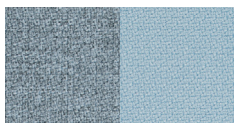

L06 L07

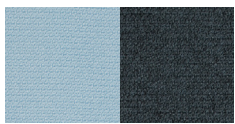

L07 L20

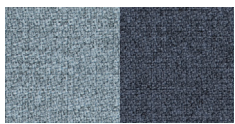

L06 L14



L19 L14

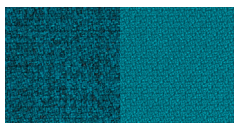

L02 L03

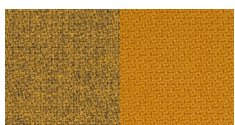

L16 L17

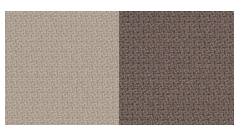

L15 L21

Synergy

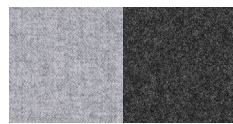

S08 S17

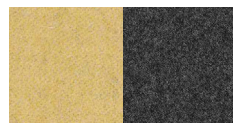

S45 S17

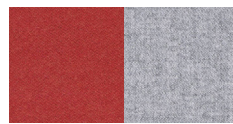

S85 S08

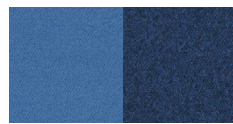

S63 S62

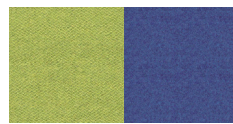

S46 S68



S59 S55

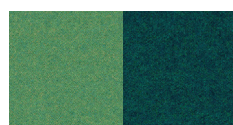

S53 S50

Velito

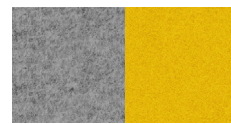

GU2 GP3

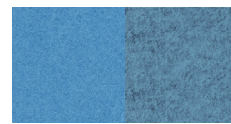

GT1 GT9

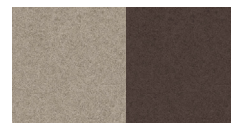

GT4 GU8



GT5 GU9

Berta

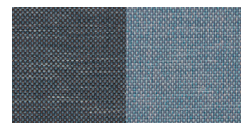

AD4 AD6

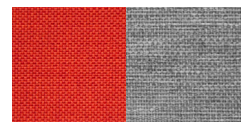

AI5 AD2

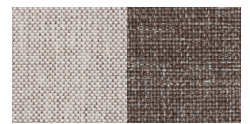

AD8 AD5

Era



C06 C11



C15 C20

RNN

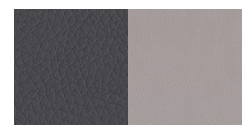

D20 D21



D17 D18