

# Walraven VibraTek® MR-B 750/M8 Rubber Mount

Bell-shaped rubber isolator for equipment and machinery

## Walraven VibraTek® MR-B

## Features and benefits



- Ideally suited for machinery with radial vibration (as opposed to axial) and prone to sudden or pronounced starts and stops)
- Recommended for machinery with working speeds above 2500 RPM, providing a degree of vibration insulation from 75% to 80%
- Metal and rubber parts can be separated for recycling

## Technical Drawing

## Applications

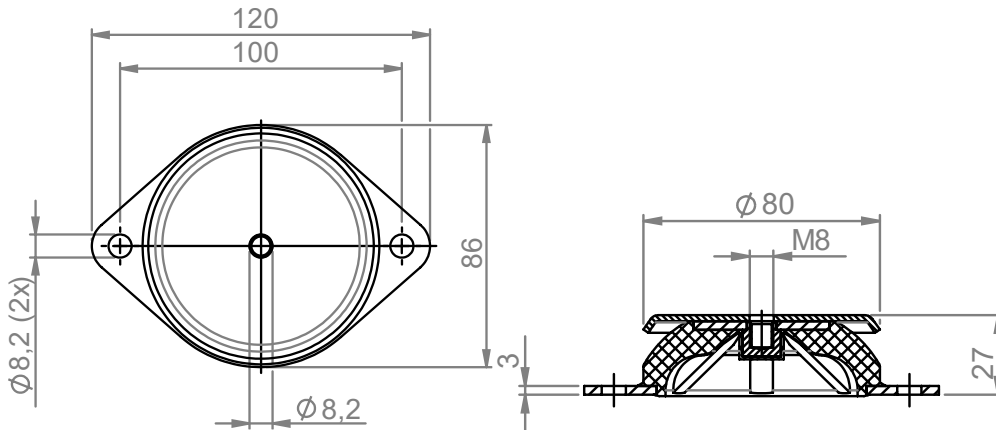

- Industrial fans, industrial air conditioning systems, industrial compressors, generators

## 1. Product and packaging details

Article	Description	Dimension	Pack 1		Pack 2	
			[pcs]	EAN13	[pcs]	EAN13
2801800750	MR-B Rubber Mount	750/M8	1	8719942047531	50	8719942047548

## 2. Performance data

Article	Description	Dimension	Max. Deflection	Min. load	Max. load	Min. optimal load	Max. optimal load
			[mm]	[N]	[N]	[N]	[N]
2801800750	MR-B Rubber Mount	750/M8	4.0mm	50	750	130	700

### 2.1 Static deflection

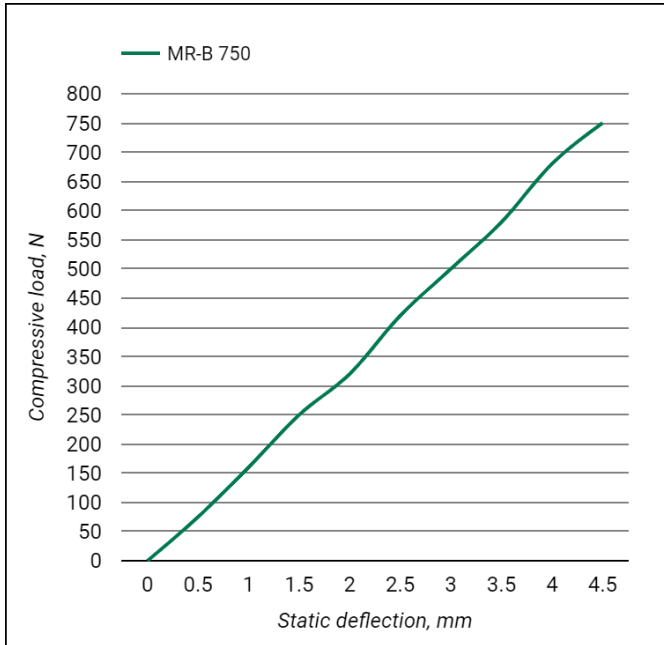

### 2.2 Isolation efficiency

