

Cooker hob Foster Milano 7647 000

Cooker hobs

Code: 7647 000



DETAILS

Finish Foster brushed

Material AISI 304 stainless steel

Texture Satin

Supply 220-240 V; 50.60 Hz

Edge/Installation Type Q4 (4 mm Edge)

Dimensions 820x560 mm

Base size 90cm

Heating element Four burners

Cut out 800x540 mm

Grids Cast iron grids and enamelled burner covers

Total power 9.950 W

Auxiliary 1.000 W

Semirapid 1.750 W

Rapid 3.000 W

Dual 4.200 W

Power settings 9 power settings per zone

Safety Safety valve with quick-acting thermocouple

Ignition Electric ignition under knob

Gas type Tested for installation with natural gas, LPG nozzle set included.

Type Gas Hob

EQUIPMENT

1 x Cast iron wok support 9601
727

FEATURES

56 cm deep

56 cm deep. An increased dimension synonymous with great functionality, which distinguishes the Foster Milano series.

Aeo burners

The AEO burners guarantee up to 25% energy saving compared to standard burners. All models are designed with The Dual burner with 2 independent crowns, controlled by a single knob, delivers from 1 to 5KW, a power that can only be found in professional models.

Cast iron grids

Cast-iron is the ideal material for an hob grid, this due to the manifold properties characterising it: high heat capacity that improves cooking performance; high weight and stability that improve safety; sturdiness that preserves the hob's original aspect over time; easy cleaning.

Safe cooking

All Foster cooker hobs are equipped with safety valves. They shut off the gas supply very quickly if the flame accidentally goes out.

Special burners

Many Foster hobs are equipped with special burners, with two or three rings of fire that greatly increase the power delivered and the heated surface. In the DUAL models the two fire crowns also have independent ignition, making these burners perfect for both intensive and delicate cooking.

Under-knob ignition

The utmost freedom of movement with electronic under-knob ignition, a common feature of all models that allows a one-hand ignition of the burner.

XXL grids

The weighty enamelled cast iron grid has extraordinary dimensions, 33x25 cm, with a working surface up to 50% bigger compared to a standard cooker hob. Now you can use all the burners at the same time even with large cookware.

TECHNICAL DATA

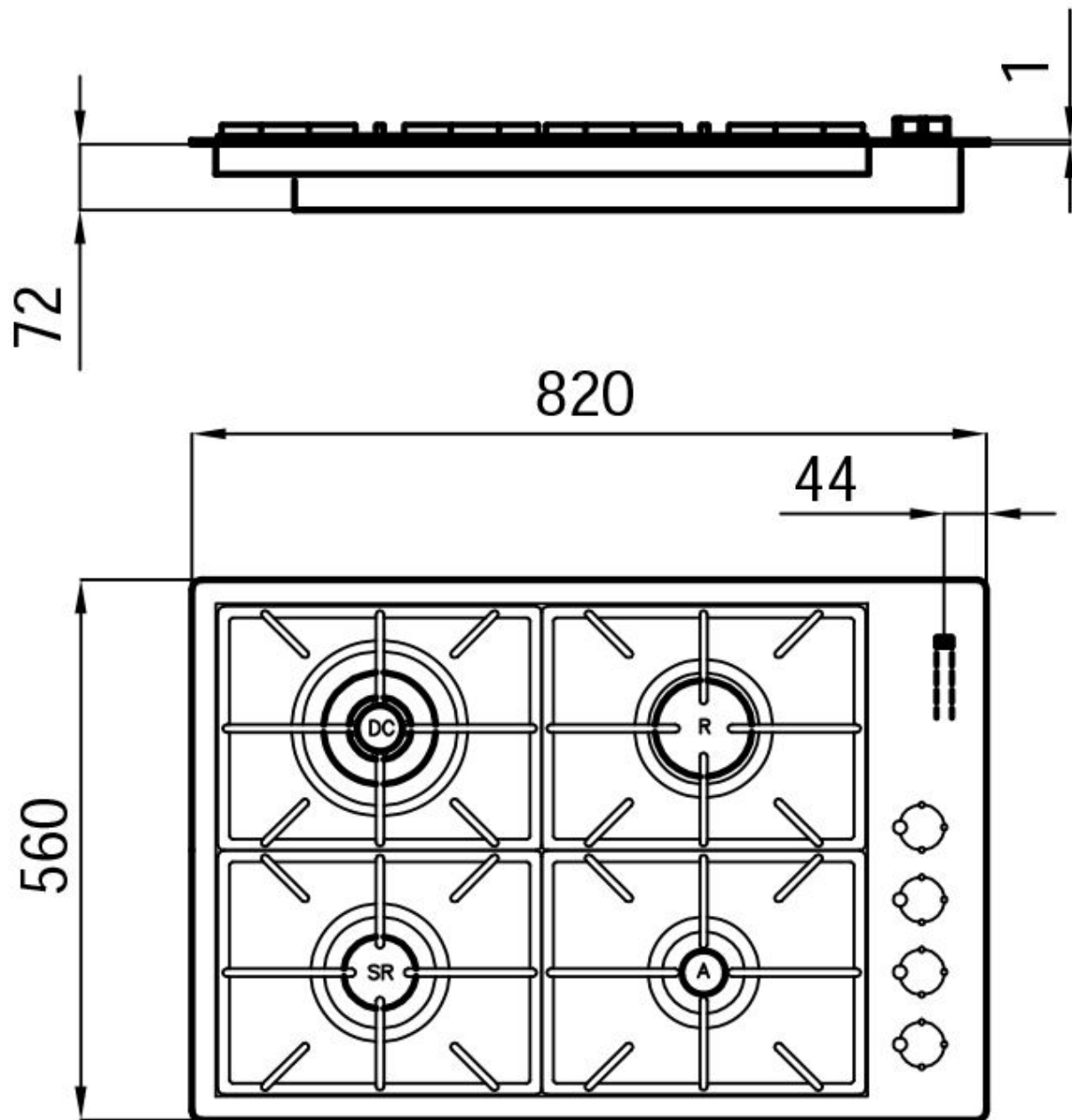

GALLERY



EQUIPMENT



Cast iron wok support 9601 727

OPTIONAL ACCESSORIES



Induction Pro - Cookware set -
8pcs 8210 008