

Features

- Single-speed whirlpool offers performance and value, with 6 fully adjustable jets.
- Hydromassage flow and direction can be controlled at each jet.
- Generous 6-foot length provides an incredibly spacious bathing area.
- Hourglass shape adds style and elegance to your bathroom.
- Textured bottom surface.
- Multiple pump location options give you more choices for installation and access. (See specification sheet for pump locations.)

Material

- Acrylic.

Hydrotherapy

- Whirlpool.

Installation

- Drop-in.

Recommended Products/Accessories

K-1283 Removable Apron
K-1491 Bath/Whirlpool Pillow
K-9696 Whirlpool 6-Jet Trim Kit
K-24916 Wireless Music Kit
K-1601 Bath/Whirlpool Footstop
K-7213 27" Cable Bath Drain
K-7214 27" Cable Bath Drain
K-7259 Clearflo Bath Drain
K-23726 Drain treatment
K-23732 Tub & shower cleaner
K-37380 30" Rough-in Cable Bath Drain
K-37383 Rough-in cable bath drain, PVC, 30" cable with tubing
K-7265 Clearflo Bath Drain
K-37386 rough-in cable drain, PVC, 30" cable



Codes/Standards





ASME A112.19.7/CSA B45.10
CSA B45.5/IAPMO Z124
ASTM E162
ASTM E662
UL 1795

**KOHLER® Plastic Baths and Receptors
Lifetime Limited Warranty
KOHLER® Hydrotherapy Components
Five-Year Limited Warranty**

See website for detailed warranty information.

Available Colors/Finishes

Color tiles intended for reference only.

Color	Code	Description
	0	White
	96	Biscuit
	47	Almond
	NY	Dune
	G9	Sandbar

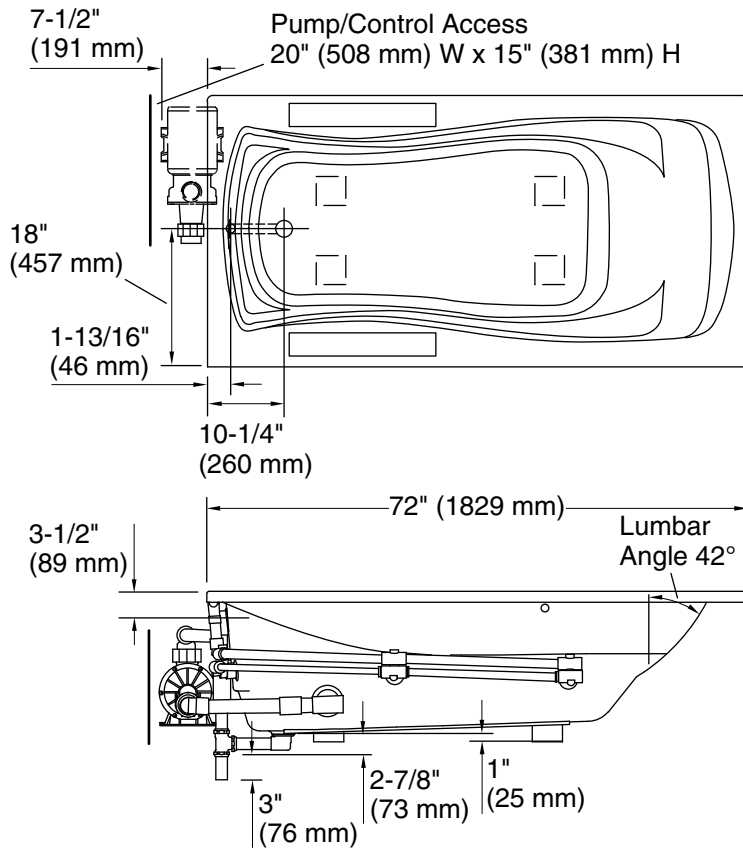

No change in measurements if connected with drain illustrated. (K-7161-AF)

□ Recommended Faucet Location

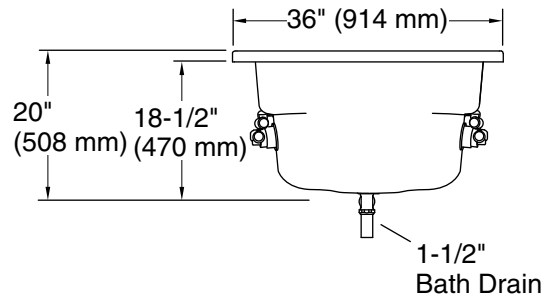
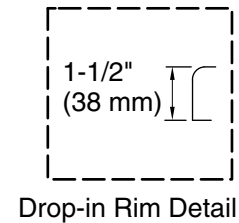

Required Electrical Service

One dedicated circuit required, protected with Class A Ground-Fault Circuit-Interrupter (GFCI). Outside North America, this device may be known as a Residual Current Device (RCD).

Pump: 120 V, 15 A, 60 Hz

Technical Information

All product dimensions are nominal.

Installation: Drop-in
 Drain location: End
 Basin area, bottom: 50" x 24" (1270 mm x 610 mm)
 Basin area, top: 65" x 27" (1651 mm x 686 mm)
 Weight: 110 lbs (49.9 kg)
 Minimum floor load: 41 lbs/ft² (200.2 kg/m²)
 Water depth: 14" (356 mm)
 Water capacity: 72 gal (272.5 L)
 Cutout: Drop-in, 70" x 34" (1778 mm x 864 mm)
 Electrical component rating: Pump: 120 V, 7.5 A, 60 Hz
 Pump speed: Single
 Minimum flat for door: 2-1/8" (54 mm)

Notes

Measure your actual product for rough-in details. Install this product according to the installation instructions.

The hot water supply should be 70% of the capacity of the bath or greater. Installations will vary.

Pump must be relocated to custom position at the time of installation. Provide adequate clearance.

If installing a rim-mount faucet, make sure there is no interference above or below the deck before drilling any holes.